



# RELAYS

Modular electronic devices



[www.elkoep.com](http://www.elkoep.com)



**30** years  
of innovations





**ELKO EP**

**ELKO EP have been your partner in the field for 30 years, developing and manufacturing the highest quality electronic devices for electroinstallation as well as smart system for residential and building automation.**

ELKO EP employs more than 330 people across 15 foreign branches and exports its products to more than seventy countries. Company of the Year, Visionary of the Year, Superbrands and Global Exporter of the Year are just some of the awards we have received throughout the years as we consistently strive to move forward in the field of innovation and development.

Millions of relays, thousands of smart homes, hundreds of buildings and many satisfied customers - This is ELKO EP; a traditional company based in the center of Europe, where own development, production, logistics, and service are at the forefront of our focus.



# Facts and stats



**30 %**

Czech

**40 %**

Export

**30 %**

Branches



## WORLDWIDE

11 branches  
3 franchises  
70 export countries



**350**

Employees  
in holding



**30 000 +**

iNELS  
installations



**30 000 000 +**

Manufactured  
products

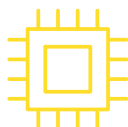

## R&D

Continuously  
innovative



## MANUFACTURER

Fully automated  
complete proces



## SUPPORT

24 / 7 / 365

**World leader**  
in DIN rail relays production



# Product lines ELKO EP



## Timers/Relays

[www.elkoep.com/relays](http://www.elkoep.com/relays)

Time relays, auxiliary relays, installation contactors, memory and bistable relays, staircase switches, time switches, twilight and light switches, dimmers and light intensity controllers, power supplies and bell transformers, controlling and signalling devices.



## Monitoring/Protection relays

[www.elkoep.com/monitoring](http://www.elkoep.com/monitoring)

Voltage relays 1-phase and 3-phase (undervoltage, overvoltage, phase failure, phase asymmetry and phase sequence), current relays, liquid level relays, thermostats, voltage indicator, power factor and frequency monitoring relays.



## Wireless electro-installation iNELS

[www.elkoep.com/wireless](http://www.elkoep.com/wireless)

Components of smart wireless system can be easily and quickly used in existing buildings where it is not desirable to cut holes for cables (e.g. add/change a light switch when changing room layouts). However, it is also possible to assemble a complete system for apartment or house control, intelligent control of heating, blinds or scene settings. When using the eLAN-RF gateway, the entire installation can also be controlled by an application from a mobile phone, tablet or television.



## Hotel Wireless Retrofit (HRESK)

[www.elkoep.com/retrofit](http://www.elkoep.com/retrofit)

Hotel Room Energy Saving Kit - is a complete solution designed primarily for existing hotel rooms and is based on the iNELS Wireless system. It focuses on the following areas: "Energy savings": switching off all appliances when leaving the room or not overheating/not overcooling, "Comfort" - all out of bed and "Safety": bell, guest in the room, maid, visitor.



## Smart kits

[elkoep.com/smart-kits](http://elkoep.com/smart-kits)

Smart Kits are pre-packaged sets of our most popular wireless control devices from the iNELS Wireless product range. The devices in the set are paired and ready for immediate assembly. Kits are divided according to their main functions, so customers can easily choose from the following categories: Wireless switch, Wireless dimming, Wireless shutter control and others.



## Wired electro-installation iNELS

[www.elkoep.com/wired](http://www.elkoep.com/wired)

The sensors and actuators, together with the central unit, which is the heart of the system, communicate via a 2-wires and enable the built up a larger installation for family houses, villas, hotels and buildings. Individual functions of elements are parameterized in iDM SW, so simple and more complex actions can be set.



## Hospitality Hotel (GRMS)

[www.elkoep.com/hospitality](http://www.elkoep.com/hospitality)

Guest Room Management System – is a comprehensive solution designed primarily for new hotels, guesthouses or wellness and is based on the iNELS BUS system. In the room, it resolves the control of lighting, access, temperature control and audio/video distribution. It features glass panels with touch buttons that can be combined in various ways (numbers, shape, and colours) and customized (description, logo).



## Time switch SHT-13, SHT-13/2 with Wi-Fi connection



NEW

In 2023, we have prepared a new product for you, i.e. time switch clock with Wi-Fi connection. You can enjoy a **new display** that is well readable and also well arranged. A type with **one or two** output contacts will be available for selection. The time switch has got completely reworked settings menu (that copies the web interface for easier orientation). We have preserved the original control that is the same as with our older models. The time switch supports **all time programs** (daily, weekly, yearly, astro).

**Here is a short list of some main improvements:**

- Setting and control through a web interface (incl. creation of backup and optional import)
- Pulse/cyclic modes of output contacts
- Optional repetition of program setting
- Bar graph of output contacts
- Icons for each channel separately
- Indication of the battery state
- Synchronization of time using the NTP server (requires connection to the internet)
- Increased number of memory places to 200 and up to 30 memory places for holidays

## Multifunction current monitoring relay in 1P - PRI-34

It is a new line of PRI-34 current monitoring relays in a **multifunction** design. All types now measure **TRUE RMS** values (thus with minimal fault regardless of the shape of measured current). Of course, it is possible to **connect external current transformers** (possible extension of the measured range up to 1600A). There is a choice of eight functions incl. the memory ones.

**Individual types are divided** according to the nominal monitored current:

- PRI-34/1 A – monitored range AC 0.05 - 1 A
- PRI-34/2 A – monitored range AC 0.1 - 2 A
- PRI-34/5 A – monitored range AC 0.25 - 5 A
- PRI-34/8 A – monitored range AC 0.4 - 8 A
- PRI-34/16 A – monitored range AC 0.8 - 16 A



NEW

## Multifunction voltage monitoring relay in 1P - HRN-3x, PMR1

The original HRN-3x types on a DIN rail will be replaced by new ones that are **multifunction** and bring several improvements. Now you have options with **one or two** output contacts. The **design into a socket** is the PMR1 model. As well as the previous novelty, also this one measures **TRUE RMS** values. This is related with monitoring of **DC voltage in higher ranges**. The original DC range was slightly modified for optional monitoring of 24V batteries. Multifunctionality enables the selection of up to nine functions incl. memory ones. Also an **external input** for memory reset was added.

**Individual types are divided** according to the monitored range:

**On DIN rail:**

- HRN-31, HRN-31/2, HRN-32/2 – monitored range AC/DC 48 to 276V
- HRN-36, HRN 36/2 – monitored range DC 6 to 30V
- HRN-39, HRN 39/2 – monitored range AC/DC 24 to 150V

**Into a socket:**

- PMR1-31, PMR1-31/2 – monitored range AC/DC 48 to 276V
- PMR1-36, PMR1-36/2 – monitored range DC 6 to 30V
- PMR1-39, PMR1-39/2 – monitored range AC/DC 24 to 150V



NEW



	<b>DESIGN</b>	
<b><u>TIME RELAYS - MULTIFUNCTION</u></b>		
CRM-161   Multifunction time relay - <b>economy</b> version .....	(1-MODULE)	12
CRM-91H, CRM-93H   Multifunction time relays - <b>BESTSELLER</b> .....	(1-MODULE)	13
<b>NEW</b> CRM-91H-SL, CRM-93H-SL   Multifunction time relays - <b>screwless terminals</b> .....	(1-MODULE)	14
<b>NEW</b> CRM-9S   Multifunction timerelay - <b>solid state output</b> .....	(1-MODULE)	15
CRM-91HE   Multifunction time relay <b>with external potentiometer</b> .....	(1-MODULE)	16
<b>NEW</b> CRM-101   Energy-saving time relay (INNOVATION).....	(1-MODULE)	18
CRM-111H, CRM-113H   Multifunction time relays <b>with inhibit delay</b> .....	(1-MODULE)	20
CRM-121H   Multifunction time relay <b>with galvanically separated control input</b> .....	(1-MODULE)	22
CRM-131H   Multifunction time relay <b>with three control inputs</b> .....	(1-MODULE)	24
CRM-82TO   <b>True off delay</b> time relay .....	(1-MODULE)	26
<b><u>TIME RELAYS - SINGLEFUNCTION, SPECIAL</u></b>		
CRM-2T   <b>STAR</b> (Λ)/ <b>DELTA</b> (Δ) time relay .....	(1-MODULE)	27
CRM-181J, CRM-183J   <b>Singlefunction</b> time relays .....	(1-MODULE)	28
CRM-2H   Asymmetric flasher .....	(1-MODULE)	30
CRM-2HE   Asymmetric flasher <b>with external potentiometers</b> .....	(1-MODULE)	31
SJR-2   ON DELAY time relay, 2-channels .....	(1-MODULE)	32
<b><u>TIME RELAYS - PLUG-IN</u></b>		
PTRM-216TP, PTRM-216KP   Multifunction time relays <b>with inhibit delay</b> .....	(11-PIN)	33
PTRM-216T, PTRM-216K   Multifunction time relays <b>with potential-free control input</b> .....	(11-PIN)	34
PTRA-216T, PTRA-216K   Multifunction time relays <b>with three control inputs</b> .....	(11-PIN)	35
<b><u>TIME RELAYS - DIGITAL</u></b>		
CRM-100   Multifunction time relay <b>with LCD display</b> .....	(1-MODULE)	36
PDR-2/A, PDR-2/B   <b>Programmable</b> digital relays .....	(3-MODULE)	38
<b><u>TIME RELAYS - IN THE INSTALLATION BOX</u></b>		
SMR-K, SMR-T, SMR-H, SMR-B   Super-multifunction time relays .....	(BOX)	40
<b><u>STAIRCASE SWITCHES</u></b>		
CRM-46   <b>Smart</b> staircase switch .....	(1-MODULE)	42
CRM-4   Staircase switch .....	(1-MODULE)	44
<b><u>TIME SWITCHES</u></b>		
<b>NEW</b> SHT-13, SHT-13/2   <b>Multifunction digital</b> time switch <b>with Wi-Fi</b> connection .....	(2-MODULE)	46
SHT-1, SHT-1/2   <b>Digital</b> time switches <b>with weekly/yearly</b> program .....	(2-MODULE)	47
<b>NEW</b> ATS-1DR   <b>Analog</b> time switches <b>with daily</b> program .....	(1-MODULE)	48
<b>NEW</b> ATS-2D, ATS-2DR, ATS-2WR   <b>Analog</b> time switches <b>with daily/weekly</b> program .....	(2-MODULE)	49
<b><u>AUXILIARY RELAYS</u></b>		
VS116B/230, VS116K, VS116U, VS308K, VS308U, VS316/24, VS316/230   Auxiliary relays .....	(BOX/1-MODULE)	51
<b><u>INSTALLATION CONTACTORS</u></b>		
VS120, VS220, VS325, VS340, VS363 VS420, VS425, VS440, VS463   Installation contactors .....	(1/2/3-MODULE)	55
VSM220, VSM425   Installation contactors <b>with manual control</b> .....	(1/2-MODULE)	56
<b><u>MEMORY AND BISTABLE (IMPULSE) RELAYS</u></b>		
MR-41, MR-42   Memory relays .....	(1-MODULE)	61
BR-216, BR-220, BR-232   Bistable (impulse) relays .....	(1-MODULE)	62
<b><u>TWILIGHT AND LIGHT SWITCHES</u></b>		
SOU-1   <b>Analog</b> twilight switch .....	(1-MODULE)	64
SOU-2   <b>Digital</b> twilight and light switch <b>with integrated time switch</b> .....	(2-MODULE)	65
SOU-3   Twilight and light switch <b>with integrated sensor</b> in increased protection .....	(IP65)	66
<b><u>POWER SUPPLIES AND BELL TRANSFORMERS</u></b>		
PSB-10, PS-30-R   <b>Switching</b> power supplies <b>DC - unregulated</b> (PSB-10), <b>regulated</b> (PS-30-R) .....	(BOX/3-MODULE)	69
PS1M, PS2M, PS3M, PS4M   <b>Switching</b> power supplies <b>DC - unregulated</b> .....	(1/2/3/4-MODULE)	70
<b>NEW</b> ZSR-30, ZNP-10   <b>Analog</b> power supplies <b>AC/DC - regulated</b> (ZSR-30), <b>unregulated</b> (ZNP-10) .....	(3-MODULE)	72
ZTR-8-8, ZTR-8-12, ZTR-15-12   Bell transformers .....	(2/3-MODULE)	73
<b><u>DIMMERS AND LIGHT INTENSITY CONTROLLERS</u></b>		
DIM-15, SMR-M   Universal dimmers .....	(1-MODULE/BOX)	76
DIM-2   Dimmer <b>with stair case switch function</b> .....	(1-MODULE)	78
SMR-S   Controlled dimmer .....	(BOX)	79
DIM-6   Controlled universal dimmer .....	(6-MODULE)	80
DIM6-3M-P   Expandable power module for dimmer DIM-6 .....	(3-MODULE)	81
LIC-1   Light intensity controller <b>with direct output</b> (R-L-C-ESL-LED) .....	(1-MODULE)	82
<b>NEW</b> RFDEL-76M   Universal dimmer, 6-channels .....	(6-MODULE)	83



**CONTROLLING AND SIGNALING MODULES**

**DESIGN**

USS | Controlling and signaling modules ..... (1-MODULE) 85

**VOLTAGE 1-PHASE**

**NEW** HRN-31, HRN-32/2, HRN-39 | Multifunction voltage monitoring relays in **1P - AC/DC** ..... (1-MODULE) 89

**NEW** HRN-36 | Multifunction voltage monitoring relay in **1P - DC** ..... (1-MODULE) 89

**NEW** PMR1-31, PMR1-39 | Multifunction voltage monitoring relays in **1P - AC/DC** ..... (8-PIN) 91

**NEW** PMR1-36 | Multifunction voltage monitoring relay in **1P - DC** ..... (8-PIN) 91

**NEW** HRN-41, HRN-42 | Voltage monitoring relays in **1P - AC/DC (INNOVATION)** ..... (3-MODULE) 93

**VOLTAGE 3-PHASES**

HRN-55, HRN-55N | Voltage monitoring relays in **3P with fixed levels** ..... (1-MODULE) 95

HRN-57, HRN-57N | Voltage monitoring relays in **3P with adjustable levels (without phase failure)** ..... (1-MODULE) 96

HRN-54, HRN-54N | Voltage monitoring relays in **3P with adjustable levels** ..... (1-MODULE) 97

HRN-56 | Voltage monitoring relays in **3P with adjustable level Umin** ..... (1/3-MODULE) 98

**NEW** HRN-43, HRN-43N | Voltage monitoring relays for complete control in **3P incl. asymmetry (INNOVATION)** ..... (3-MODULE) 99

**NEW** HRN3-70, PMR3-70 | Voltage monitoring relays in **3P with selectable range** ..... (3-MODULE/8-PIN) 101

**NEW** HRN3-80, HRN3-81 | Voltage monitoring relays in **3P - selectable range (HRN3-80), fixed range (HRN3-81)** ..... (1-MODULE) 103

HRN-100 | Multifunction voltage/frequency monitoring relay in **3P with LCD display** ..... (2-MODULE) 105

**SPECIAL**

MPS-1 | **Light indicator** of voltage in 3P ..... (1-MODULE) 108

COS-2 | **Power factor** monitoring relay ..... (3-MODULE) 109

HRF-10 | **Frequency** monitoring relay ..... (3-MODULE) 111

**CURRENT**

PRI-32 | Current monitoring relay of **I<sub>max</sub> level passing through a hole in 1P - AC** ..... (1-MODULE) 113

**NEW** PRI-34 | **Multifunction** current monitoring relays in **1P - AC** ..... (1-MODULE) 114

PRI-35 | Undercurrent monitoring relay in **1P - AC by external CT** ..... (1-MODULE) 116

**NEW** PRI-41, PRI-42 | Current monitoring relays of **I<sub>min</sub> and I<sub>max</sub> level in 1P - AC/DC (INNOVATION)** ..... (3-MODULE) 117

PRI-51 | Current monitoring relays of **I<sub>max</sub> level in 1P - AC** ..... (1-MODULE) 118

PRI-52 | Current monitoring relay of **I<sub>max</sub> level passing through a hole in 1P - AC** ..... (1-MODULE) 119

PRI-53 | Current monitoring relay of **I<sub>min</sub> or I<sub>max</sub> level in 3P** ..... (6-MODULE) 120

**LEVEL**

HRH-5 | Level switch for monitoring **1 or 2 levels** ..... (1-MODULE) 122

HRH-7 | Level switch for monitoring **1 or 2 levels in increased protection** ..... (IP65) 123

HRH-8 | **Multifunction** level switch for monitoring **1 or 2 levels** ..... (3-MODULE) 125

HRH-9 | **Universal** level switch for monitoring **up to 6 levels** ..... (6-MODULE) 127

HRH-6 | Level switch for monitoring **5 levels in increased protection** ..... (IP65) 129

HRH-4 | **Set** of level switch HRH-5 and contactor VS-425 in **increased protection** ..... (IP65) 131

**ACCESSORIES FOR LEVEL SWITCHES**

SHR-1N, SHR-1M, SHR-2, SHR-3 | Level probes ..... 132

D03VV-F, D05V-K | Cables and wires ..... 133

**THERMOSTATS**

TER-3A, TER-3B, TER-3C, TER-3D, TER-3G, TER-3H | Single-level thermostats **with ranges from -30 .. +70 °C** ..... (1-MODULE) 136

TER-3E, TER-3F | Single-level thermostats **with range from 0 .. +60 °C** ..... (1-MODULE) 137

TER-7 | Thermostat for monitoring **temperature of motor winding** ..... (1-MODULE) 138

**NEW** TER-4 | **Double** thermostat **with a range of -40 .. +110 °C (INNOVATION)** ..... (3-MODULE) 139

TER-9 | **Digital** thermostat **with integrated time switch** ..... (2-MODULE) 141

TEV-1 | Two-level thermostat **with a range of -20 .. +20 °C** in increased protection ..... (IP65) 143

TEV-2, TEV-3 | Single-level thermostats **with ranges of -20 .. +35 °C** in increased protection ..... (IP65) 144

TEV-4 | Single-level thermostat **with range of -30 .. +60 °C** in increased protection ..... (IP65) 145

**HYGROSTATS**

RHT-1 | RHT-1 | Hygrothermostat **with temperature range 0 .. +60 °C and humidity 50 - 90 %** ..... (1-MODULE) 146

RHV-1 | Hygrostat **with humidity range 0 - 90%** in increased protection ..... (IP65) 147

**THERMOSTAT ACCESSORIES**

ATV-1 | Energy-saving digital thermo-valve ..... 148

TELVA-2 230 V, TELVA-2 24V | Thermodriver TELVA ..... 149

TC, TZ, Pt100 | Temperature sensors ..... 150

**TECHNICAL DETAILS**

Training, technical support ..... 151

Loadability of products ..... 152

Product packaging ..... 155

Dimensions ..... 156

Examples of use ..... 163

## Multifunction



CRM-161

6 functions, 6 time ranges, output contact 1x 8 A changeover, power supply AC 24-240 V, DC 24 V, economy version of CRM-91H. page 12



CRM-91H

10 functions, 10 time ranges, 1x output 16 A changeover/SPDT, multivoltage or 230 V supply. page 13



CRM-93H

As CRM-91H, but output 1x 16 A + 2x 8 A changeover/SPDT. page 13



CRM-91H-SL

As CRM-91H but with screwless terminals. page 14



CRM-93H-SL

As CRM-93H, but with screwless terminals page 14



CRM-9S

As CRM-91H, but with solid state output (triac), 1.5 A page 15



CRM-91HE

As CRM-91H but with time setting by external potentiometer (for frequent setting). page 16



CRM-101

Relay for the automatic switching on and off of electricity in rooms, using connected sensors (motion detector and magnetic door contact). page 18



CRM-111H

11 functions 10 time ranges, output contact: 1x 16 A changeover. page 20



CRM-113H

10 functions, 10 time ranges, output contact: 1x 16 A + 2x 8 A changeover, mode selection of output contacts. page 20



CRM-121H

As CRM-111H, but with galvanically separated input. page 22



CRM-131H

11 functions, 10 time ranges, output contact: 1x 16 A changeover, three control inputs. page 24



CRM-82TO

"TRUE OFF DELAY" relay - switch off after power supply failure, for backup circuits. page 26

## Singlefunction, special



CRM-2T

Star/delta timer relay page 27



CRM-181J

Variants of 4 functions with time range 0.1s - 100 h, output 1x 16 A changeover, UNI power supply. page 28



CRM-183J

As CRM-181J, but output 1x16A + 2x 8 A changeover. page 28



CRM-2H

Asymmetric flasher, independent time setting ON/OFF. page 30



CRM-2HE

As CRM-2H, but time setting by external potentiometers (for frequent setting). page 31



SJR-2

2-channels ON DELAY, gradual switching of high loads. page 32

## PLUG-IN



PTRM-216TP

10 functions, 10 time ranges, output contact: 2x 16 A changeover, voltage dependent input, mode selection of output contact, tuning with dials. page 33



PTRM-216KP

As PTRM-216TP, but fine tuning using a knob. page 33



PTRM-216T

10 functions, 10 time ranges, output contact: 2x 16 A changeover, potential-free input, mode selection of output contact, dial tuning. page 34



PTRM-216K

As PTRM-216T, but fine tuning using a knob. page 34



PTRM-216T

10 function, 10 time ranges, output contact 2x 16 A changeover, three control inputs and mode selection of output contact, tuning with dials. page 35



PTRM-216K

As PTRM-216T, but fine tuning help with a knob. page 35



Digital



CRM-100

17 functions, time range 0.1 s - 999 hours, 1x 8 A changeover contact, power supply 24-240 V AC/DC. page 36



PDR-2A

4 digit display, 16 functions, 2 independent times 0.01s-100 hrs, 2 outputs 16 A changeover/SPDT START/STOP inputs. page 38



PDR-2B

As PDR-2A, but instead of 2 independent times, 10 functions for each output contact separated, START input for each output contact. page 38

In the installation box



SMR-K

Super multifunction relay for installation into an installation box, 3 wire connection (without neutral). Input: can be connected in parallel with LED energy saving light bulb or fluorescent lamp. page 40



SMR-T

Super multifunction relay for installation into a wiring box, 3 wire connection (without neutral). Input: up to 50 glow lamps can be connected. page 40



SMR-H

As SMR-T, but 4 wire connection, output - triac 0-200 VA, 9 functions including function of memory relay. page 40



SMR-B

As SMR-H, but output relay contact 16 A (possibility to switch also fluorescent lights and LED). page 40

Staircase switches



CRM-46

Time 0.5 - 10 min, automatic with the possibility of warning before switching off and extending the set delay by the number of button presses. page 42



CRM-4

Basic version, time 0.5-10 min, output contact 16 A, anti-blocking function. page 44



DIM-2

With dimming, setting: dim-up/shining/dim-down brightness only for R-L-LED<sup>1</sup> loads. page 78

Accessories



Potentiometer for CRM-91HE

External control element - 5 kΩ, (linear), mounting into the panel, max. connection length 10 m (32.8 ft.). EAN code: 8595232367967



Potentiometer for CRM-2HE

External control element - 10 kΩ, (linear), mounting into the panel, max. connection length 10 m (32.8 ft.). EAN code: 8595232367981



Potentiometer for CRM-91HE + CRM-2HE

External control element - 47 kΩ, (linear), mounting into the panel, max. connection length 10 m (32.8 ft.). EAN code: 8595232125215

1-MODULE



Comb busbar CB-17-8

Serves for mass connection of up to eight power supply contacts A1 or A2, it is suitable for all relays with a width of 17.5 mm (0.69") (1-MODULE) Pack of 10 pcs. EAN code: 8598188181892

	CRM-161	CRM-91H, CRM-91H-SL	CRM-93H, CRM-93H-SL	CRM-9S	CRM-91HE	CRM-111H	CRM-113H	CRM-121H	CRM-131H	CRM-82TO	CRM-2T	CRM-181J ZR	CRM-181J ZN	CRM-181J BL	CRM-181J OD	CRM-183J ZR	CRM-183J ZN	CRM-183J BL	CRM-183J OD	CRM-2H	CRM-2HE	SJR-2	PTRM-216TP	PTRM-216KP	PTRM-216T	PTRM-216K	PTRA-216T	PTRA-216K	CRM-100	PDR-2/A	PDR-2/B	CRM-4	CRM-46	SMR-K	SMR-T	SMR-H	SMR-B								
<b>Design</b>																																													
1-MODULE	•	•	•	•	•	•	•	•	•	•	•	•	•	•	•	•	•	•	•	•	•	•	•							•				•	•										
3-MODULE																																	•	•											
PLUG-IN																								•	•	•	•	•	•																
Under the switch																																				•	•	•	•						
<b>Control elements</b>																																													
Rotary switches/potentiometers	•	•	•	•	•	•	•	•	•	•	•	•	•	•	•	•	•	•	•	•	•	•	•	•	•	•	•	•	•					•	•	•	•	•	•						
Large rotary knob																									•		•		•																
Buttons																																													
External potentiometer					•																	•																							
<b>Time range</b>																																													
50 ms – 0.5 s							•	•	•	•														•	•	•	•	•	•																
0.1 – 1 s	•	•	•	•	•	•	•	•	•	•	•	•	•	•	•	•	•	•	•	•	•	•	•	•	•	•	•	•	•	•							•	•	•	•					
1 – 10 s	•	•	•	•	•	•	•	•	•	•	•	•	•	•	•	•	•	•	•	•	•	•	•	•	•	•	•	•	•	•							•	•	•	•					
3 – 30 s												•	•	•	•	•	•	•	•	•	•	•	•	•	•	•	•	•	•									•	•	•	•				
0.1 – 1 min	•	•	•	•	•	•	•	•	•	•	•	•	•	•	•	•	•	•	•	•	•	•	•	•	•	•	•	•	•									•	•	•	•				
1 – 10 min	•	•	•	•	•	•	•	•	•	•	•	•	•	•	•	•	•	•	•	•	•	•	•	•	•	•	•	•	•									•	•	•	•				
3 – 30 min												•	•	•	•	•	•	•	•	•	•	•	•	•	•	•	•	•											•	•	•	•			
0.1 – 1 h	•	•	•	•	•	•	•	•	•	•	•	•	•	•	•	•	•	•	•	•	•	•	•	•	•	•	•	•	•									•	•	•	•				
1 – 10 h	•	•	•	•	•	•	•	•	•	•	•	•	•	•	•	•	•	•	•	•	•	•	•	•	•	•	•	•	•									•	•	•	•				
3 – 30 h												•	•	•	•	•	•	•	•	•	•	•	•	•	•	•	•	•											•	•	•	•			
0.1 – 1 d		•	•	•	•	•	•	•	•	•	•	•	•	•	•	•	•	•	•	•	•	•	•	•	•	•	•	•	•									•	•	•	•				
1 – 10 d												•	•	•	•	•	•	•	•	•	•	•	•	•	•	•	•	•											•	•	•	•			
10 – 100 h		•	•	•	•	•	•	•	•	•	•	•	•	•	•	•	•	•	•	•	•	•	•	•	•	•	•	•	•									•	•	•	•				
3 – 30 d							•	•	•	•	•										•	•	•	•	•	•	•	•												•	•	•	•		
10 – 100 d											•										•	•																				•	•	•	•
0.5 – 10 min																																									•	■			
0.01s – 100 h																																									•	•			
0.1s – 999 h																																									•				
<b>Supply voltage</b>																																													
AC 230 V		□	□								•										•	•																•	•	•	•				
AC/DC 12–240 V		•	•	•	•	•	•	•	•	•	•	•	•	•	•	•	•	•	•	•	•	•	•	•	•	•	•	•	•									•	•						
AC 24–240 V, DC 24 V	•																																												
AC/DC 24–240 V																																										•			
<b>Output contact</b>																																													
1x changeover 8 A	•																																							•					
1x changeover 16 A		•			•	•		•	•			•	•	•	•						•	•																		•					
2x changeover 8 A											•																																		
2x changeover 16 A											•													•	•	•	•	•	•	•												•	•		
1x switching 16 A																																										•		•	
1x changeover 16 A, 2x changeover 8 A			•				•										•	•	•	•																									
Solid state (triac)				•																																						•	•	•	•

- only for CRM-91H, CRM-93H
- with the option of extending it to 30 min



	CRM-161	CRM-91H, CRM-91H-SL	CRM-93H, CRM-93H-SL	CRM-9S, CRM-91HE	CRM-111H	CRM-113H	CRM-121H	CRM-131H	CRM-82TO	CRM-2T	CRM-181J ZR	CRM-181J ZN	CRM-181J BL	CRM-181J OD	CRM-183J ZR	CRM-183J ZN	CRM-183J BL	CRM-183J OD	CRM-2H	CRM-2HE	SJR-2	PTRM-216x	PTRM-216xP	PTRA-216x	CRM-100	PDR-2/A	PDR-2/B	CRM-4	CRM-46	SMR-K	SMR-T	SMR-H	SMR-B				
<b>Functions</b>																																					
Staircase switch																																				●	
Programmable stair controller (with/without signaling)																																				●	
Delayed start	●	●	●	●	●	●	●	●	●	●	●			●									●	●	●	●	■	●									
Delayed start with delay suppression					●	●	●				●			●									●	●		●	■	●									
Delayed start after switching on the control contact	●																									●	■	●					●	●	●	●	
Delayed start after opening of the control contact																										●	■	●									
Delayed start after closing and delayed return after opening the control contact		●	●	●	●	●	●	●	●	●													●	●	●	●	■					●	●	●	●		
Delayed start (repeatable) until the power is turned off																																				●	
Delayed start star / triangle											●																	■									
2x delayed start																							●														
Delayed return	●	●	●	●	●	●	●	●	●	●		●		●									●	●	●	●	■	●									
Delayed return with delay suppression					●	●	●				●			●									●	●		●	■	●									
Delay off on downward edge																																			●	●	●
Delayed return after power off										●																											
Delayed return after closing the control contact		●	●	●	●	●	●	●	●	●													●	●	●	●	■	●									
Delayed return after opening the control contact		●	●	●																						●	■	●					●	●	●	●	
Delayed return after opening the control contact with immediate closing of the output	●	●	●	●	●	●	●	●	●	●			●				●						●	●	●	●	■	●			●	●	●	●			
Delayed return after closing the control contact - renewable					●	●	●	●	●	●													●	●	●	●	■										
Delayed return after closing and opening of the control contact					●	●	●	●	●	●													●	●	●	●	■										
Delayed return when closing the control contact with delayed output																											■	●									
Flasher 1:1 starting with an impulse	●	●	●	●	●	●	●	●	●	●		●		●									●	●	●	●	■	●									
Flasher 1:1 starting with a delay-suppressed impulse												●					●																				
Flasher 1:1 starting with an impulse while the control button is pressed																																		●	●	●	●
Flasher 1:1 starting with a gap		●	●	●	●	●	●	●	●	●													●	●	●	●	■	●									
Flasher 1:1 starting with a gap while the control button is pressed																																		●	●	●	●
Asymmetric flasher starting with an impulse																							●	●		●	■										
Asymmetric flasher starting with a gap																							●	●		●	■										
Impulse relay		●	●	●	●	●	●	●															●	●								●	●	●	●		
Impulse relay with delay	●				●		●	●	●	●																							●	●	●	●	
Pulse generator		●	●	●	●	●	●	●	●	●													●	●	●	●	■										
Pulse generator with delay suppression					●	●	●																●	●													

- functions controlled by inputs START, INHIBIT, RESET
- functions controlled by inputs START, STOP



EAN code  
CRM-161: 8595188181617

**Technical parameters CRM-161**

**Power supply**

Supply terminals:	A1 - A2
Voltage range:	AC 24 - 240 V   DC 24 V (AC 50-60 Hz)
Power input (max.):	2 VA/1.5 W
Supply voltage tolerance:	-15 %; +10 %
Supply indication:	green LED

**Time circuit**

Number of functions:	6
Time ranges:	0.1 s - 10 hrs
Time setting:	rotary switch and potentiometer
Time deviation:	5 % - mechanical setting
Repeat accuracy:	0.2 % - set value stability
Temperature coefficient:	0.01 %/°C, at = 20 °C (0.01 %/°F, at = 68 °F)

**Output**

Number of contacts:	1x changeover/SPDT (AgNi)
Current rating:	8 A/AC1; 1/2 HP 240 Vac, 1/3 HP 120 Vac; PD, B300
Breaking capacity:	2000 VA/AC1, 192 W/DC
Switching voltage:	250 V AC/24 V DC
Max. power dissipation:	0.6 W
Output indication:	multifunction red LED
Mechanical life:	10.000.000 ops.
Electrical life (AC1):	100.000 ops.

**Control**

Control. terminals:	A1-S
Load between S-A2:	Yes
Impulse length:	min. 25 ms/max. unlimited
Reset time:	max. 150 ms

**Other information**

Operating temperature:	-20 .. +55 °C (-4 .. 131 °F)
Storage temperature:	-30 .. +70 °C (-22 .. 158 °F)
Dielectric strength:	4kV AC (supply - output)
Operating position:	any
Mounting:	DIN rail EN 60715
Protection degree:	IP40 from front panel/IP20 terminals
Overvoltage category:	III.
Pollution degree:	2
Max. cable size (mm <sup>2</sup> ):	solid wire max. 1x 2.5 or 2x 1.5/ with sleeve max. 1x 2.5 (AWG 12)
Dimensions:	90 x 17.6 x 64 mm (3.5" x 0.7" x 2.5")
Weight:	62 g (2.2 oz.)
Standards:	EN 61812-1

- Multifunction economy version of time relay for universal use in automation, control and regulation or in house installations.
- Universal supply voltage: AC 24 – 240 V (AC 50/60 Hz) and DC 24 V.
- Comfortable and well-arranged function and time-range setting by rotary switches.
- Time scale 0.1 s - 10 hrs divided into 6 ranges: (0.1 s - 1 s/1 s - 10 s/0.1 min - 1 min/1 min - 10 min/0.1 hrs - 1 h/1 h - 10 hrs).
- Output contact: 1x changeover/SPDT 8 A.
- Multifunction red LED flashes or shines depending on the operating status.

**Description**

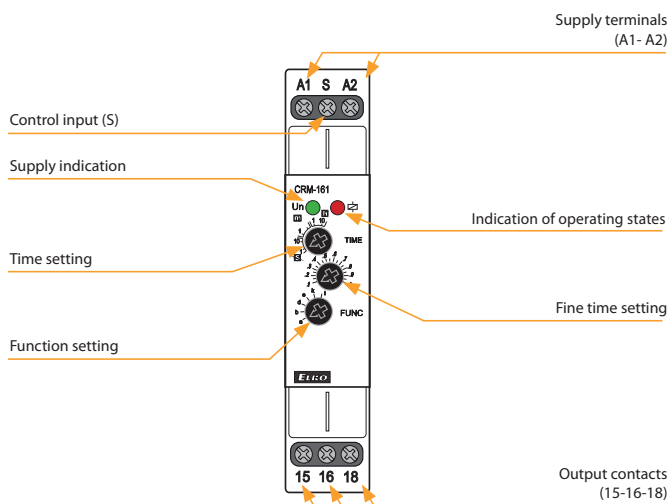

**Functions**

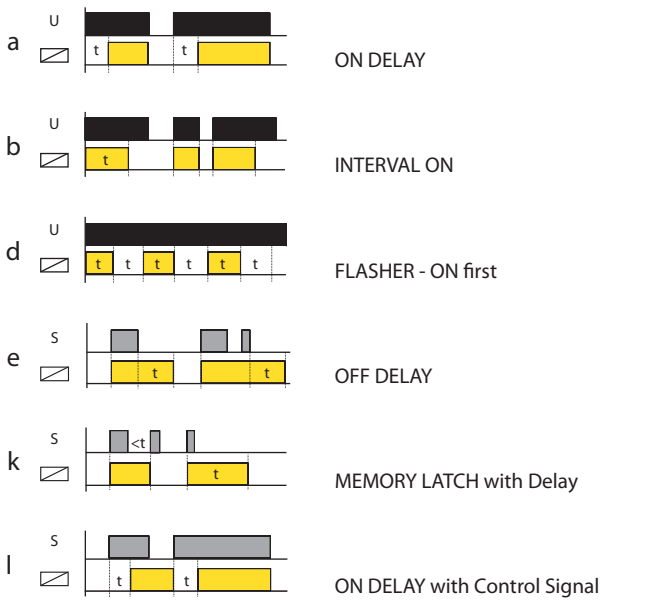

**Connection**

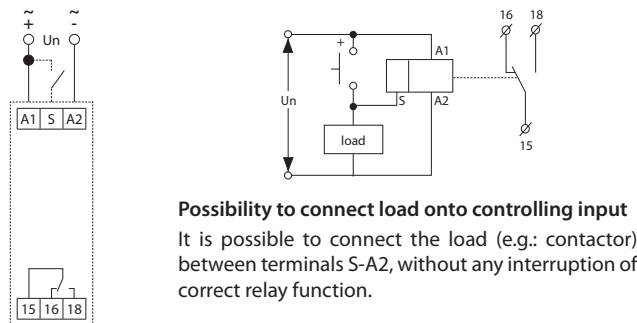

**Possibility to connect load onto controlling input**  
It is possible to connect the load (e.g.: contactor) between terminals S-A2, without any interruption of correct relay function.

**Indication of operating states**

Examples of signaling

Function a

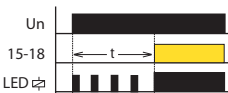

Function e

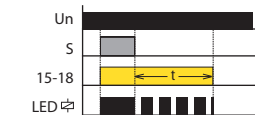



EAN code  
 CRM-91H/230V: 8595188112444  
 CRM-91H/UNI: 8595188112420  
 CRM-93H/230V: 8595188112789  
 CRM-93H/UNI: 8595188112468

- Multifunction time relay for universal use in automation, control and regulation or in house installations.
- Comfortable and well-arranged function and time-range setting by rotary switches.
- Multifunction red LED flashes or shines depending on the operating status.

Technical parameters	CRM-91H	CRM-93H
<b>Power supply</b>		
Supply terminals:	A1 - A2	
Voltage range:	AC/DC 12 - 240 V (AC 50-60 Hz)	
Power input (max.):	2 VA/1.5 W	2.5 VA/1.5 W
Voltage range:	AC 230 V (50/60 Hz)	
Power input (max.):	3VA/1.4W	4VA/2W
Supply voltage tolerance:	-15 %; +10 %	
Supply indication:	green LED	
<b>Time circuit</b>		
Number of functions:	10	
Time ranges:	0.1 s - 10 days	
Time setting:	rotary switch and potentiometer	
Time deviation:	5 % - mechanical setting	
Repeat accuracy:	0.2 % - set value stability	
Temperature coefficient:	0.01 %/°C, at = 20 °C (0.01 %/°F, at = 68 °F)	
<b>Output</b>		
Number of contacts 1:	1x changeover/SPDT (AgNi)	
Current rating:	16 A/AC1; 1 HP 240 Vac, 1/2 HP 120 Vac; PD. B300	
Breaking capacity:	4000 VA/AC1, 384 W/DC	
Electrical life (AC1):	100.000 ops.	
Number of contacts 2 (3):	x	2x chang./DPDT (AgNi)
Current rating:	x	8 A/AC1; 1/2 HP 240Vac; PD. B300
Breaking capacity:	x	2000 VA/AC1, 192 W/DC
Electrical life (AC1):	x	50.000 ops.
Switching voltage:	250 V AC/24 V DC	
Max. power dissipation:	1.2 W	2.4 W
Output indication:	multifunction red LED	
Mechanical life:	10.000.000 ops.	
<b>Control</b>		
Control terminals:	A1-S	
Load between S-A2:	Yes	
Impulse length:	min. 25 ms/max. unlimited	
Reset time:	max. 150 ms	
<b>Other information</b>		
Operating temperature:	-20 .. +55 °C (-4 .. 131 °F)	
Storage temperature:	-30 .. +70 °C (-22 .. 158 °F)	
Dielectric strength:		
supply - output 1	4kV AC	
supply - output 2 (3)	x	1kV AC
output 1 - output 2	x	1kV AC
output 2 - output 3	x	1kV AC
Operating position:	any	
Mounting:	DIN rail EN 60715	
Protection degree:	IP40 from front panel/IP20 terminals	
Overvoltage category:	III.	
Pollution degree:	2	
Max. cable size (mm <sup>2</sup> ):	solid wire max. 1x 2.5 or 2x 1.5/ with sleeve max. 1x 2.5 (AWG 12)	
Dimensions:	90 x 17.6 x 64 mm (3.5" x 0.7" x 2.5")	
Weight:	UNI - 62 g (2.2 oz.); 230 - 57 g (2 oz.)	UNI - 85 g (3oz.); 230 - 80 g (2.8 oz.)
Standards:	EN 61812-1	

**Description**

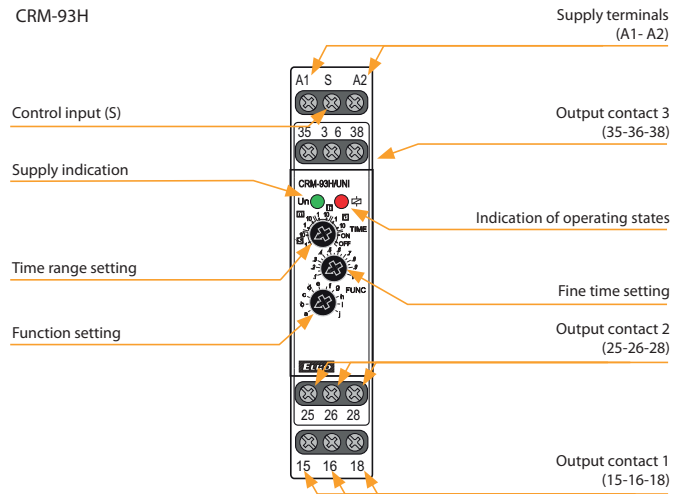

**Connection**

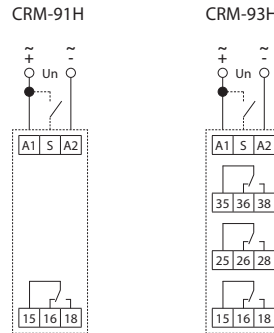

**CRM-93H:**  
 The potential difference between the supply terminals (A1-A2), output contact 2 (25-26-28) and output contact 3 (35-36-38) must be a maximum of 250V AC rms/DC.

**Possibility to connect load onto controlling input**

It is possible to connect the load (e.g.: contactor) between terminals S-A2, without any interruption of correct relay function.

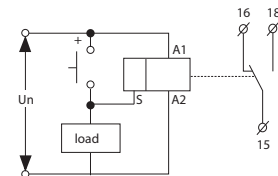

**Indication of operating states**

**Examples of signaling**

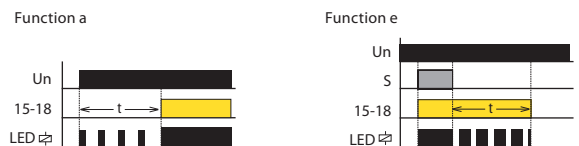

**Function**

Function (page 17).



NEW



EAN code  
CRM-91H/UNI-SL: 8595188184816  
CRM-93H/UNI-SL: 8595188184823

Technical parameters	CRM-91H-SL	CRM-93H-SL
<b>Power supply</b>		
Supply terminals:	A1-A2	
Supply voltage:	AC/DC 12 – 240 V (AC 50-60 Hz)	
Consumption (max.):	2 VA/1.5 W	2.5 VA/1.5 W
Supply voltage tolerance:	-15 %; +10 %	
<b>Time circuit</b>		
Number of functions:	10	
Time ranges:	0.1 s – 10 days	
Time setting:	rotary switch and potentiometer	
Time deviation:	5 % – mechanical setting	
Repeat accuracy:	0.2 % – set value stability	
Temperature coefficient:	0.01 %/°C, at = 20 °C (0.01 %/°F, at = 68 °F)	
<b>Output</b>		
Output contact 1:	1x changeover/SPDT (AgNi)	
Current rating:	16 A/AC1; 1 HP 240 Vac, 1/2 HP 120 Vac; PD. B300	
Breaking capacity:	4000 VA/AC1, 384 W/DC1	
Electrical life (AC1):	100.000 ops.	
Output contact 2 (3):	x	2x chang./DPDT (AgNi)
Current rating:	x	8 A/AC1; 1/2 HP 240Vac; PD. B300
Breaking capacity:	x	2000 VA/AC1, 192 W/DC
Electrical life (AC1):	x	50.000 ops.
Switching voltage:	250 V AC/24 V DC	
Power dissipation (max.):	1.2 W	2.4 W
Mechanical life:	10.000.000 ops.	
<b>Control</b>		
Control terminals:	A1-S	
Load between S-A2:	Yes	
Impulse length:	min. 25 ms / max. unlimited	
Reset time:	max. 150 ms	
<b>Other information</b>		
Operating temperature:	-20 .. +55 °C (-4 .. 131 °F)	
Storage temperature:	-30 .. +70 °C (-22 .. 158 °F)	
<b>Dielectric strength:</b>		
supply – output 1	4 kV AC	
supply – output 2 (3)	x	1 kV AC
output 1 – output 2	x	1 kV AC
output 2 – output 3	x	1 kV AC
Operating position:	any	
Mounting:	DIN rail EN 60715	
Protection degree:	IP40 front panel / IP20 terminals	
Overvoltage category:	III.	
Pollution degree:	2	
Connected wire cross-section (mm <sup>2</sup> ):	solid wire max. 1x 2.5, 2x 1.5/ with sleeve max. 1x 2.5 (AWG 12)	
Dimensions:	90 x 17.6 x 64 mm (3.5" x 0.7" x 2.5")	
Weight:	58 g (1.86 oz)	
Standards:	EN 61812-1	

- Multi-function time relay for universal use in automation, control and regulation or in house installations
- Universal supply voltage AC/DC 12 – 240V
- Easy connection with screw-less terminals
- Comfortable and well-arranged function and time-range setting by rotary switches.
- Time scale 0.1 s - 10 days divided into 10 ranges:  
(0.1 s - 1 s / 1 s - 10 s / 0.1 min - 1 min / 1 min - 10 min / 0.1 hrs - 1 h / 1 h - 10 hrs / 0.1 day - 1 day / 1 day - 10 days / only ON / only OFF)
- Output contact:  
CRM-91H-SL: 1x changeover / SPDT 16A  
CRM-93H-SL: 1x changeover / SPDT 16A, 2x changeover / DPDT 8A
- Multifunction red LED flashes or shines depending on the operating states

### Description

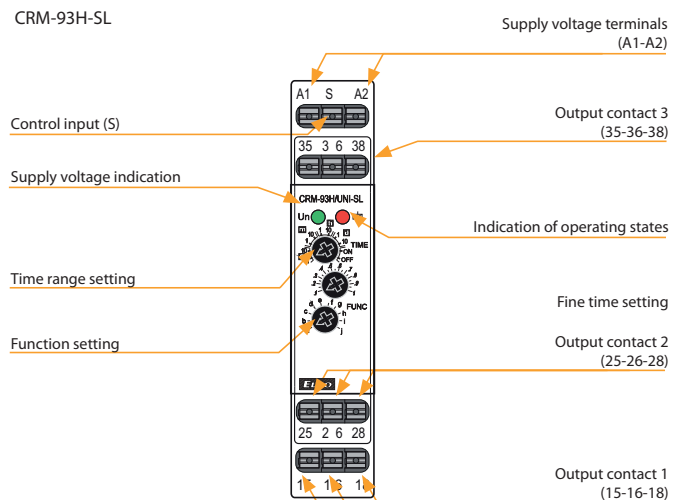

### Connection

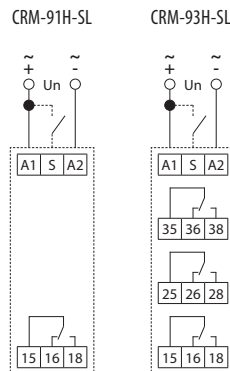

**CRM-93H-SL:**  
The potential difference between the supply terminals (A1-A2), output contact 2 (25-26-28) and output contact 3 (35-36-38) must be a maximum of 250V AC rms/DC.

### Possibility to connect load onto controlling input

It is possible to connect the load (e.g.: contactor) between terminals S-A2, without any interruption of correct relay function.

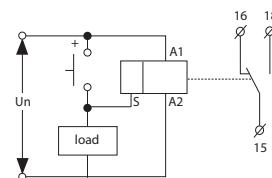

### Indication of operating states

Signaling examples:

Function **a**

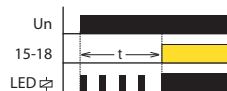

Function **e**

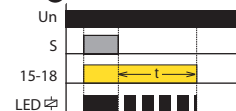

### Function

Function (page 17).



EAN code  
CRM-9S: 8595188116008

Technical parameters		CRM-9S
<b>Power supply</b>		
Supply terminals:	A1-A2	
Supply voltage:	AC 12 – 240 V (50-60 Hz)	
Consumption (max.):	3 VA/0.7 W	
Supply voltage tolerance:	-15 %; +10 %	
<b>Time circuit</b>		
Number of functions:	10	
Time ranges:	0.1 s – 10 days	
Time setting:	rotary switch and potentiometer	
Time deviation:	5 % – mechanical setting	
Repeat accuracy:	0.2 % – set value stability	
Temperature coefficient:	0.01 %/°C, at = 20 °C (0.01 %/°F, at = 68 °F)	
<b>Output</b>		
Output contact:	1x static contactless output	
Current rating:	1.5 A	
Inrush current:	60 A/< 10 ms	
Switching voltage:	250 V AC	
Power dissipation (max.):	1.4 W	
Voltage drop across switch:	max. 0.9 V/l max.	
Load to terminal B1:	Yes/l max. 1.5 A	
Electrical lifetime (AC1):	100.000.000 ops.	
<b>Control</b>		
Control terminals:	A1-S	
Load between S-A2:	Yes	
Impulse length:	min. 25 ms / max. unlimited	
Reset time:	max. 150 ms	
<b>Other information</b>		
Operating temperature:	-20 .. +55 °C	
Storage temperature:	-30 .. +70 °C	
Operating position:	any	
Mounting:	DIN rail EN 60715	
Protection degree:	IP40 front panel / IP20 terminals	
Overvoltage category:	III.	
Pollution degree:	2	
Cross-wire section – solid/stranded with ferrule (mm <sup>2</sup> ):	max. 1x 2.5, 2x 1.5/ max. 1x 2.5 (AWG 14)	
Dimensions:	90 x 17.6 x 64 mm (3.5" x 0.7" x 2.5")	
Weight:	55 g (1.95 oz)	
Standards:	EN 61812-1	

- Multifunction time relay for universal use in automation, control and regulation or in house installations
- Universal supply voltage AC 12 – 240 V
- Noiseless switching output
- Comfortable and well-arranged function and time-range setting by rotary switches.
- Time scale 0.1 s - 10 days divided into 10 ranges: (0.1 s - 1 s / 1 s - 10 s / 0.1 min - 1 min / 1 min - 10 min / 0.1 hrs - 1 h / 1 h - 10 hrs / 0.1 day - 1 day / 1 day - 10 days / only ON / only OFF)
- Output contact: 1x static contactless output (triac) 1.5 A, switches potential A1
- Multifunction red LED flashes or shines depending on the operating states

Description

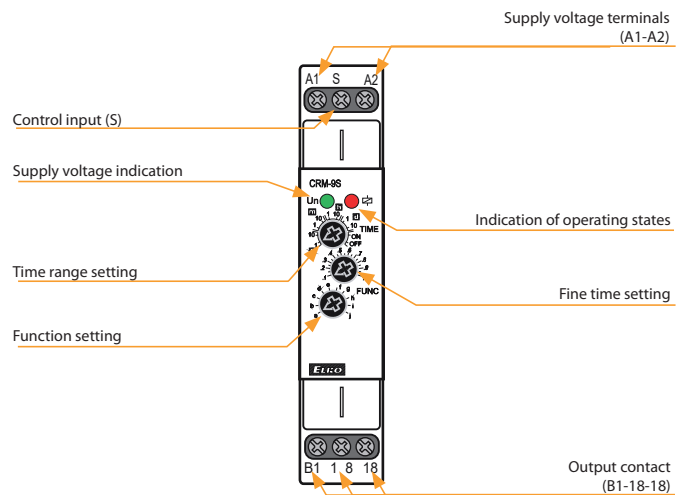

Connection

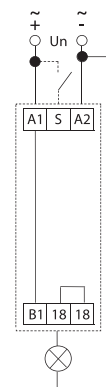

Possibility to connect load onto controlling input:

It is possible to connect the load (e.g.: contactor) between terminals S-A2, without any interruption of correct relay function.

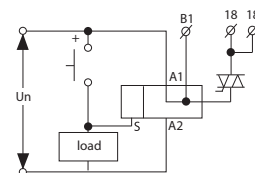

Symbol

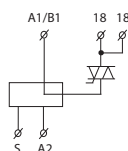

Indication of operating states

Signaling examples:

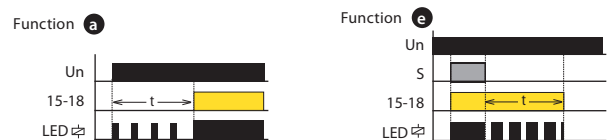

Function

Function (page 17).



EAN code  
CRM-91HE/UNI:8595188118958  
CRM-91HE/UNI + potentiometer: 8595188142052  
Potentiometer: 859232367967

Technical parameters	CRM-91HE
Number of functions:	10
Supply terminals:	A1 - A2
Supply voltage:	AC/DC 12 - 240 V (AC 50-60 Hz)
Consumption (max.):	3 VA/1.7 W
Max. dissipated power:	4 W (Un + terminals)
Supply voltage tolerance:	-15 %; +10 %
Supply indication:	green LED
Time ranges:	0.1 s - 10 days
Time setting:	rotary switch, external potentiometer
Time deviation:	5 % - mechanical setting
Repeat accuracy:	0.2 % - set value stability
Temperature coefficient:	0.01 %/°C, at = 20°C (0.01%/°F, at = 68°F)
<b>Output</b>	
Contact type:	1x changeover/SPDT (AgNi/Silver Alloy)
Current rating:	16 A/AC1; 1 HP 240 Vac, 1/2 HP 120 Vac; PD. B300
Breaking capacity:	4000 VA/AC1, 384 W/DC1
Inrush current:	30 A/<3 s
Switching voltage:	250V AC/24V DC
Output indication:	multifunction red LED
Mechanical life:	10.000.000 ops.
Electrical life (AC1):	100.000 ops.
<b>Controlling</b>	
Control voltage:	AC/DC 12 - 240 V (AC 50-60 Hz)
Consumption of input:	AC 0.025-0.2 VA/DC 0.1-0.7 W
Load between S-A2:	Yes
Glow-tubes:	No
Control. terminals:	A1-S
Impulse length:	min. 25 ms/max. unlimited
Reset time:	max. 150 ms
<b>Other information</b>	
Operating temperature:	-20 .. +55 °C (-4 .. 131 °F)
Storage temperature:	-30 .. +70 °C (-22 .. 158 °F)
Dielectrical strength:	AC 4 kV (supply - output)
Operating position:	any
Mounting:	DIN rail EN 60715
Protection degree:	IP40 from front panel/IP20 terminals
Overvoltage category:	III.
Pollution degree:	2
Cross-wire section - solid/ stranded with ferrule (mm <sup>2</sup> ):	max. 1x 2.5, 2x 1.5/ max. 1x 2.5 (AWG 12)
Dimensions:	90 x 17.6 x 64 mm (3.5" x 0.7" x 2.5")
Weight:	75 g (2.6 oz)
Standards:	EN 61812-1

Technical parameters	Potentiometer
Potentiometer:	5 - 150kΩ, linear
Protection degree:	IP 65 front side / IP20 f back side
Max. cable size (mm <sup>2</sup> ):	1.5 with sleeve/without sleeve max. 2.5 (AWG 12)
Weight:	16 g (0.6 oz.)
Dimensions:	see page Accessories

- Control by external control unit - potentiometer (can be placed/mounted for example on switch board doors or in panel).
- 10 functions:
  - 5 time functions controlled by supply voltage
  - 4 time functions controlled by control input
  - 1 function of latching relay.
- Possible to connect external potentiometer - max. distance 10 m (32.8 ft.) from relay.

## Description

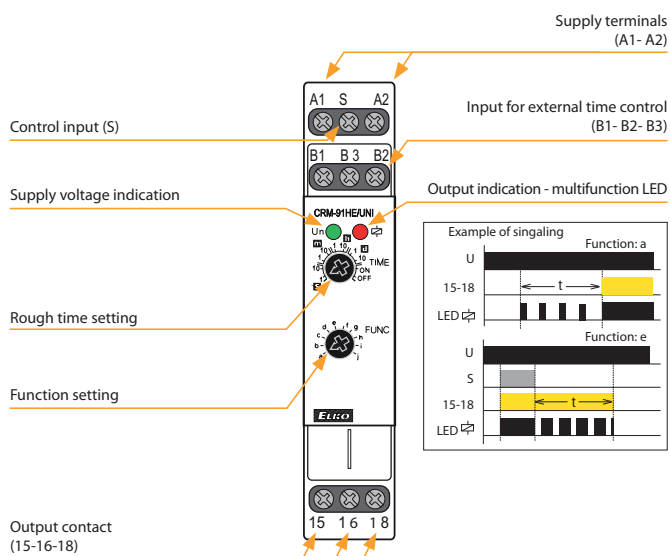

## Connection

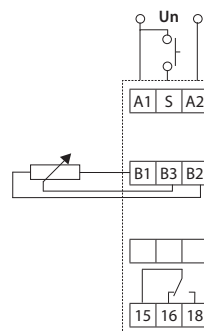

## Symbol

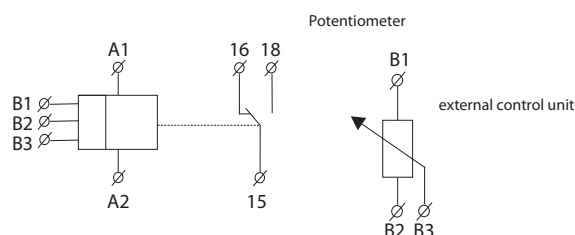



Function



**ON DELAY**  
When the input voltage U is applied, timing delay t begins. Relay contacts R change state after time delay is complete. Contacts R return to their shelf state when input voltage U is removed. Trigger switch is not used in this function.

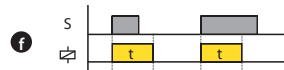

**SINGLE SHOT**  
Upon application of input voltage U, the relay is ready to accept trigger signal S. Upon application of the trigger signal S, the relay contacts R transfer and the preset time t begins. During time-out, the trigger signal S is ignored. The relay resets by applying the trigger switch S when the relay is not energized.



**INTERVAL ON**  
When input voltage U is applied, relay contacts R change state immediately and timing cycle begins. When time delay is complete, contacts return to shelf state. When input voltage U is removed, contacts will also return to their shelfstate. Trigger switch is not used in this function.

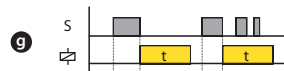

**SINGLE SHOT falling edge**  
Upon application of input voltage U, the relay is ready to accept trigger signal S. Upon application of the trigger signal S, the relay contacts R transfer and the preset time t begins. At the end of the preset time t, the relay contacts R return to their normal condition unless the trigger switch S is opened and closed prior to time out t (before preset time elapses). Continuous cycling of the trigger switch S at a rate faster than the preset time will cause the relay contacts R to remain closed. If input voltage U is removed, relay contacts R return to their shelf state.



**FLASHER - OFF first**  
When input voltage U is applied, time delay t begins. When time delay t is complete, relay contacts R change state for time delay t. This cycle will repeat until input voltage U is removed. Trigger switch is not used in this function.

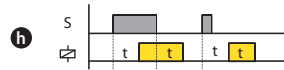

**ON/OFF DELAY**  
Input voltage U must be applied continuously. When trigger switch S is closed, time delay t begins. When time delay t is complete, relay contacts R change state and remain transferred until trigger switch S is opened. If input voltage U is removed, relay contacts R return to their shelf state.



**FLASHER - ON first**  
When input voltage U is applied, relay contacts R change state immediately and time delay t begins. When time delay t is complete, contacts return to their shelf state for time delay t. This cycle will repeat until input voltage U is removed. Trigger switch is not used in this function.

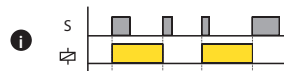

**MEMORY LATCH**  
Input voltage U must be applied continuously. Output changes state with every trigger switch S closure. If input voltage U is removed, relay contacts R return to their shelf state.

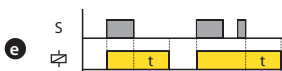

**OFF DELAY**  
Input voltage U must be applied continuously. When trigger switch S is closed, relay contacts R change state. When trigger switch S is opened, delay t begins. When delay t is complete, contacts R return to their shelf state. If trigger switch S is closed before time delay t is complete, then time is reset. When trigger switch S is opened, the delay begins again, and relay contacts R remain in their energized state. If input voltage U is removed, relay contacts R return to their shelf state.

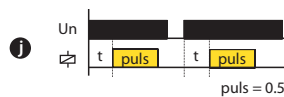

**PULSE GENERATOR**  
Upon application of input voltage U, a single output pulse of 0.5 seconds is delivered to relay after time delay t. Power must be removed and reapplied to repeat pulse. Trigger switch is not used in this function.

NEW



EAN code  
CRM-101/UNI: 8595188184113

## Technical parameters CRM-101

### Power supply

Supply terminals:	A1-A2
Supply voltage:	AC/DC 12 – 240 V (AC 50-60 Hz)
Consumption (max.):	2 VA/1.5 W
Supply voltage tolerance:	-15 %; +10 %

### Time circuit

Time t0:	90 s
Time range t1:	1 – 60 min ( $t1=t1a + t1b$ )
Time range t2:	0.5 – 120 s
Time setting:	rotary switches and potentiometers
Time deviation:	5 % – mechanical setting
Repeat accuracy:	0.2 % – set value stability
Temperature coefficient:	0.01 %/°C, at = 20 °C (0.01 %/°F, at = 68 °F)

### Output

Output contact:	1x changeover/ SPDT (AgNi)
Current rating:	16 A/AC1; 1 HP 240 Vac, 1/2 HP 120 Vac; PD. B300
Breaking capacity:	4000 VA/AC1, 384 W/DC1
Switching voltage:	250 V AC/24V DC
Power dissipation (max.):	1.2 W
Mechanical life:	10.000.000 ops.
Electrical life (AC1):	100.000 ops.

### Control

Control terminals:	A1-S (voltage dependent contact)
Load between S-A2:	Yes
Control terminals:	IN1-IN1, IN2-IN2 (potential-free contacts)
Impulse length:	min. 25 ms / max. unlimited
Reset time:	max. 150 ms

### Other information

Operating temperature:	-20 °C .. +55 °C (-4 °F .. 131 °F)
Storage temperature:	-30 °C .. +70 °C (-22 °F .. 158 °F)
Dielectric strength:	4kV AC (supply – output)
Operating position:	any
Mounting:	DIN rail EN 60715
Protection degree:	IP40 front panel / IP20 terminals
Overvoltage category:	III.
Pollution degree:	2
Cross-wire section – solid/ stranded with ferrule (mm <sup>2</sup> ):	max. 1x 2.5, 2x 1.5/ max. 1x 2.5 (AWG 12)
Dimensions:	90 × 17.6 × 64 mm (3.5" × 0.7" × 2.5")
Weight:	70 g (2.5 oz)
Standards:	EN 61812-1

- Time relay for automatic switching on and off of electricity, with the help of connected sensors (can be combined with a regular card switch)
- 2 control inputs – **potential-free contacts**:  
IN1 (MD) – motion detector  
IN2 (MC) – magnetic door contact
- 1 control input – **voltage dependent contact**:  
S (MD) – motion detector
- Adjustable configuration of control inputs:  
(closing – NO / opening – NC, according to the type of connected sensors)
- Time delay t1 (delayed switch-off of electricity)  
Adjustable in the range of 1 – 60 min in minute steps
- Time delay t2 (input blocking for motion detector)  
Adjustable continuously in the range 0.5 – 120 s

## Description

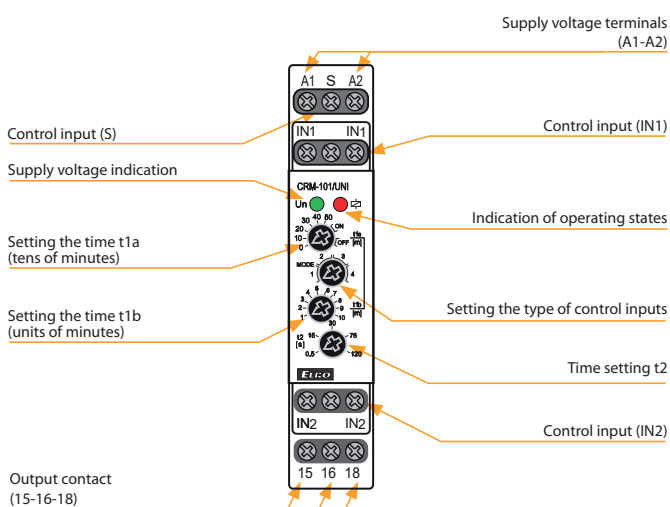

## Setting the type of control inputs

MODE	IN1/S	IN2
1	NO	NO
2	NO	NC
3	NC	NO
4	NC	NC

### Setting example:

- Door contact is NC (closed when the door is closed)
- Motion detector has NC contact (closed at rest, opens when motion is detected)
- MODE must be set to position 4

## Connection

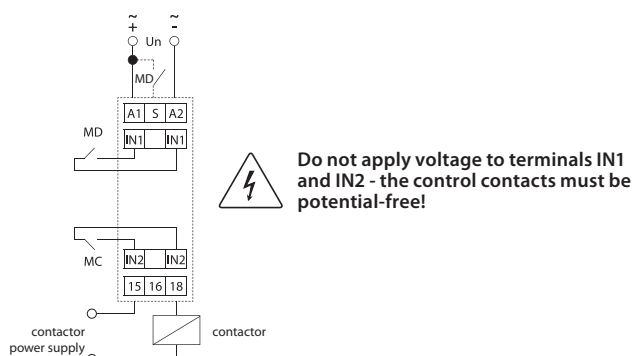

Function

Graph and description of the function corresponds to the setting of MODE 1 control inputs.

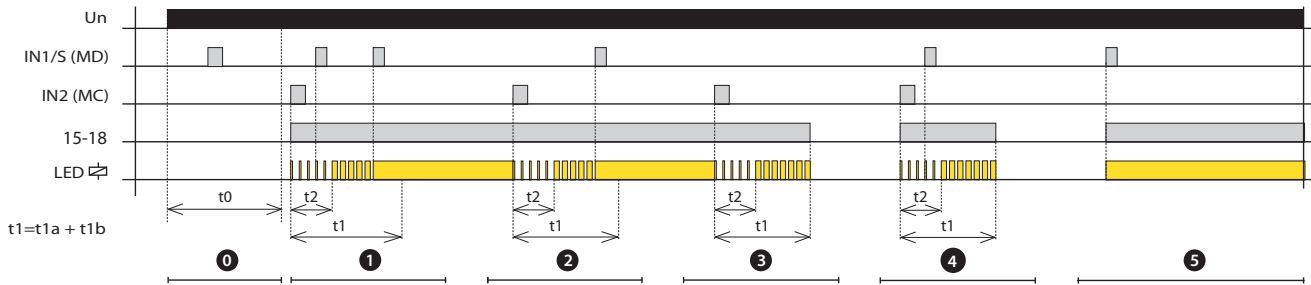

0 Motion detector blocking

After switching on the power supply, inputs IN1/S are blocked for a period of  $t_0$ .

1 Arrival of persons in the room

When people enter the room, IN2 is activated (MC - magnetic door contact)  
 - Closes the relay (turns on the electricity) and at the same time the delay  $t_1$  and  $t_2$  starts  
 - The red LED flashes depending on the delay in progress.  
 Contact IN1 (MD - motion detector), responds to the movement of people in the room  
 - During the delay  $t_2$ , the MD operation is blocked  
 - If IN1/S is activated after the delay  $t_2$  has elapsed or if the contact is already closed, the delay  $t_1$  ends and the red LED lights up permanently. The relay remains permanently closed.

2 Person leaving the room

When the person leaves the room, contact IN2 is activated  
 - Delays  $t_1$  and  $t_2$  start at the same time  
 - If there is a movement in the room after the delay  $t_2$  has elapsed, IN1/S is activated, the delay  $t_1$  is terminated and the relay remains closed

3 Last person leaving the room

When the person leaves the room, contact IN2 is activated  
 - Delays  $t_1$  and  $t_2$  start at the same time  
 - If IN1/S is not activated after the delay  $t_2$  has elapsed (no movement in the room), then after the delay  $t_1$  the red LED goes out and the relay opens (switches off the electricity).

4 No movement after delay  $t_2$

When people enter the room, IN2 is activated (MC - magnetic door contact)  
 - Closes the relay (turns on the electricity) and at the same time the delay  $t_1$  and  $t_2$  starts  
 - If IN1/S is not activated after the delay  $t_2$  has elapsed (e.g. a brief insight into the room), then after the delay  $t_1$  the red LED goes out and the relay opens (switches off the electricity).

5 Movement at rest

In case the IN1/S does not activate the relay (switches off the electricity) after the person leaves the room after the delay  $t_2$  has elapsed. However, another person remains in the room motionless (e.g. sleeping)  
 - If IN1/S is activated (e.g. by waking up a sleeping person), the relay closes without delay (turns on the electricity).



EAN code  
CRM-111H/UNI: 8595188175548  
CRM-113H/UNI: 8595188180634

Technical parameters	CRM-111H	CRM-113H
<b>Power supply</b>		
Supply terminals:	A1 - A2	
Voltage range:	AC/DC 12 - 240 V (AC 50/60 Hz)	
Power input (max.):	2 VA/1.5 W	2.5 VA/1.5 W
Supply voltage tolerance:	-15 %; +10 %	
Supply indication:	green LED	
<b>Time circuit</b>		
Number of functions:	11	10
Time ranges:	50 ms - 30 days	
Time setting:	rotary switches and potentiometers	
Time deviation*:	5 % - mechanical setting	
Repeat accuracy:	0.2 % - set value stability	
Temperature coefficient:	0.01 %/°C, at = 20 °C (0.01 %/°F, at = 68 °F)	
<b>Output</b>		
Number of contacts 1:	1x changeover/SPDT (AgNi)	
Current rating:	16 A/AC1; 1 HP 240 Vac, 1/2 HP 120 Vac; PD. B300	
Breaking capacity:	4000 VA/AC1, 384 W/DC	
Electrical life (AC1):	100.000 ops.	
Number of contacts 2 (3):	x	2x chang./DPDT (AgNi)
Current rating:	x	8 A/AC1; 1/2 HP 240Vac; PD. B300
Breaking capacity:	x	2000 VA/AC1, 192 W/DC
Electrical life (AC1):	x	50.000 ops.
Switching voltage:	250V AC/24 V DC	
Max. power dissipation:	1.2 W	2.4 W
Output indication:	multifunction red LED	
Mechanical life:	10.000.000 ops.	
<b>Control</b>		
Control terminals:	A1-S	
Load between S-A2:	Yes	
Impulse length:	min. 25 ms/max. unlimited	
Reset time:	max. 150 ms	
<b>Other information</b>		
Operating temperature:	-20 .. +55 °C (-4 .. 131 °F)	
Storage temperature:	-30 .. +70 °C (-22 .. 158 °F)	
Dielectric strength:		
supply - output 1	4kV AC	
supply - output 2 (3)	x	1kV AC
output 1 - output 2	x	1kV AC
output 2 - output 3	x	1kV AC
Operating position:	any	
Mounting:	DIN rail EN 60715	
Protection degree:	IP40 from front panel/IP20 terminals	
Overvoltage category:	III.	
Pollution degree:	2	
Max. cable size (mm <sup>2</sup> ):	solid wire max. 1x 2.5 or 2x 1.5/ with sleeve max. 1x 2.5 (AWG 12)	
Dimensions:	90 x 17.6 x 64 mm (3.5" x 0.7" x 2.5")	
Weight:	62 g (2.2 oz.)	85 g (3 oz.)
Standards:	EN 61812-1	

\* for adjustable delay <100 ms, a time deviation of ± 10 ms applies

- Multifunction time relay for universal use in automation, control and regulation or in house installations.
- All functions initiated by the supply voltage, except for the flasher function, can use the control input to inhibit the delay (pause).
- Mode selection - according to the set function, permanently closed, permanently open, function of MEMORY LATCH with delay (CRM-111H)/switching of the second output contact according to supply voltage (CRM-113H).
- Multifunction red LED flashes or shines depending on the operating status.

## Description

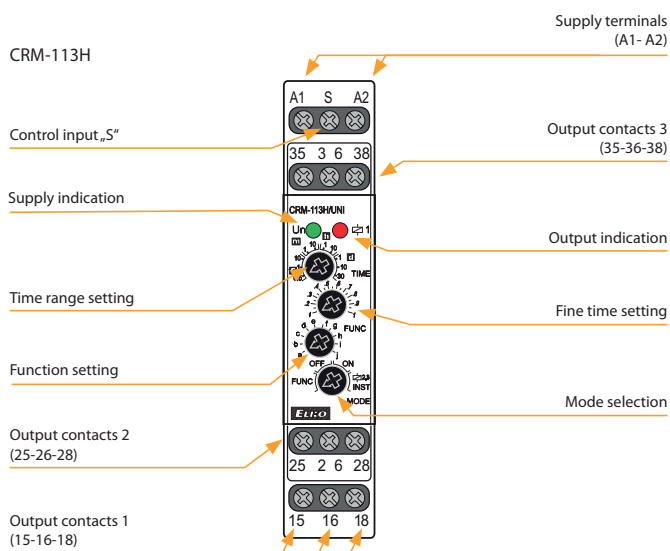

## Connection

CRM-111H

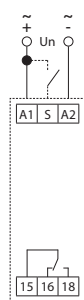

CRM-113H

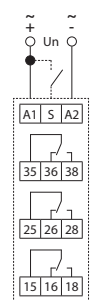

**CRM-113H:**  
The potential difference between the supply terminals (A1-A2), output contact 2 (25-26-28) and output contact 3 (35-36-38) must be a maximum of 250 V AC rms/DC.

## Possibility to connect load onto controlling input

It is possible to connect the load (e.g.: contactor) between terminals S-A2, without any interruption of correct relay function.

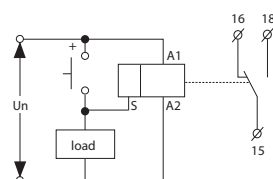



Indication of operating states



Mode selection

**FUNC. Settings function mode**

The desired function a-j is set with the FUNC rotary switch.

**OFF. Output contact open mode**



**ON. Output contact closed mode**



**k. Function: MEMORY LATCH with delay (Only for CRM-111H)**



When the supply voltage is applied, the relay is open. If the control contact is closed, the relay closes and the time delay T starts. It does not matter the length of the control pulse. When the timing is complete, the relay opens. If the control contact is closed during timing, the relay opens immediately. Each time the control contact closes during relay timing, it changes status.

**2,3 INST. Second and third output contact instantaneous (Only for CRM-113H)**



The second output contact switches according to the supply voltage. The first output contact switches according to the function (a-j) set by the trimmer FUNC.

Function

Function (page 23).



EAN code  
CRM-121H/UNI: 8595188175555

Technical parameters		CRM-121H
<b>Power supply</b>		
Supply terminals:	A1 - A2	
Voltage range:	AC/DC 12 - 240 V (AC 50-60 Hz)	
Power input (max.):	2 VA/1.5W	
Supply voltage tolerance:	-15 %; +10 %	
Supply indication:	green LED	
<b>Time circuit</b>		
Number of functions:	11	
Time ranges:	50 ms - 30 days	
Time setting:	rotary switch and potentiometer	
Time deviation*:	5 % - mechanical setting	
Repeat accuracy:	0.2 % - set value stability	
Temperature coefficient:	0.01 %/°C, at = 20 °C (0.01 %/°F, at = 68 °F)	
<b>Output</b>		
Number of contacts	1x changeover/SPDT (AgNi)	
Current rating:	16 A/AC1; 1 HP 240 Vac, 1/2 HP 120 Vac; PD. B300	
Breaking capacity:	4000 VA/AC1, 384 W/DC	
Switching voltage:	250 V AC/24 V DC	
Max. power dissipation:	1.2 W	
Output indication:	multifunction red LED	
Mechanical life:	10.000.000 ops.	
Electrical life (AC1):	100.000 ops.	
<b>Control</b>		
Control terminals:	S1-S2	
Impulse length:	min. 25 ms/max. unlimited	
Reset time:	max. 150 ms	
<b>Other information</b>		
Operating temperature:	-20 .. +55 °C (-4 ..131 °F)	
Storage temperature:	-30 .. +70 °C (-22 ..158 °F)	
Dielectric strength:	4 kV AC (supply - output) 4 kV AC (supply - control input)	
Operating position:	any	
Mounting:	DIN rail EN 60715	
Protection degree:	IP40 from front panel/IP10 terminals	
Overvoltage category:	III.	
Pollution degree:	2	
Max. cable size (mm <sup>2</sup> ):	solid wire max. 2x 2.5 or 1x 4/ with sleeve max. 1x 2.5 or 2x 1.5 (AWG 12)	
Dimensions:	90 x 17.6 x 64 mm (3.5" x 0.7" x 2.5")	
Weight:	72 g (2.5 oz.)	
Standards:	EN 61812-1	

\* for adjustable delay <100 ms, a time deviation of ± 10 ms applies

- Multifunction time relay for universal use in automation, control and regulation or in house installations.
- Galvanically separated control input (Power Trigger).
- All functions initiated by the supply voltage, except for the flasher function, can use the control input to inhibit the delay (pause).
- Mode selection - according to the set function, permanently closed, permanently open, function of MEMORY LATCH with delay.
- Time scale 50 ms - 30 days divided into 10 ranges.
- Multifunction red LED flashes or shines depending on the operating status.

## Description

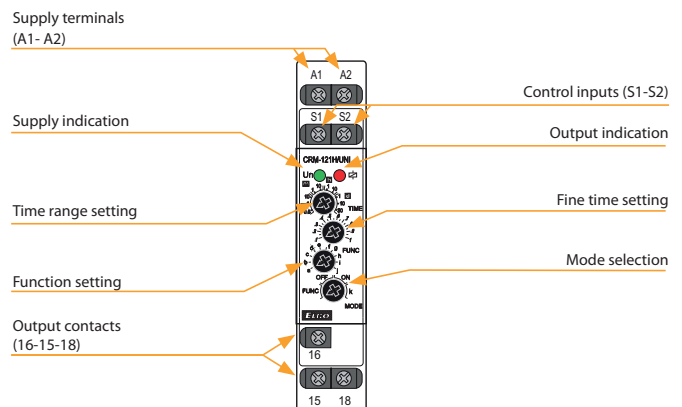

## Connection

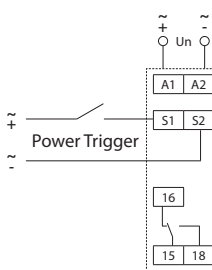

(Range of control voltage same as supply voltage)

## Indication of operating states

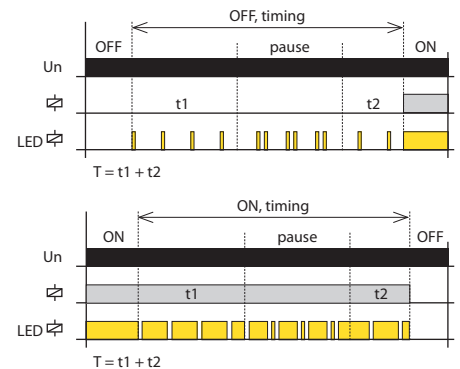

## Mode selection

### FUNC. Settings function mode

The desired function a-j is set with the FUNC rotary switch.

### OFF. Output contact open mode



### ON. Output contact closed mode



### k. Function: MEMORY LATCH with delay

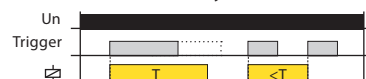

When the supply voltage is applied, the relay is open. If the control contact is closed, the relay closes and the time delay T starts. It does not matter the length of the control pulse. When the timing is complete, the relay opens. If the control contact is closed during timing, the relay opens immediately. Each time the control contact closes during relay timing, it changes status.

Function

a. ON DELAY



When the supply voltage is applied, the time delay T begins. When the timing is complete, the relay closes and this condition continues until the supply voltage is disconnected.

ON DELAY with Inhibit

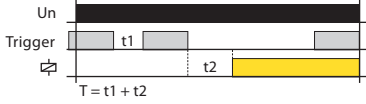

If the control contact is closed and the supply voltage is connected, the relay is opened and timing does not start until the control contact opens. When the timing is complete, the relay closes. If the control contact is closed during timing, the timing is interrupted and continues only after the control contact opens.

b. INTERVAL ON



After supply voltage relay closes and starts the delay time T. After the end of the timing relay opens and this state lasts until the supply voltage is disconnected.

INTERVAL ON with Inhibit

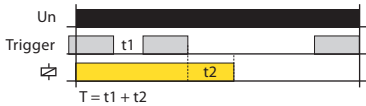

If the control contact is closed and the supply voltage is connected, the relay will close and the timing will start only after the control contact has been opened. When the timing is complete, the relay opens. If the control contact is closed during timing, the timing is interrupted and continues only after the control contact opens.

c. FLASHER - ON first



After supply voltage relay closes and starts the delay time T. After the end of the timing relay opens and again runs delay time T. When the timing is complete, the relay closes again and the sequence is repeated until the supply voltage is disconnected. If the control contact is closed during timing, this does not affect the operation of the cycler.

FLASHER - OFF first



If the control contact is closed during timing; this does not affect the operation of the cycler. If the control contact is closed and the supply voltage is connected, the cycler starts with a pause (relay open).

d. MEMORY LATCH



When the supply voltage is applied, the relay is open. When the control contact is closed, the relay closes. When the control contact is opened, the status does not change until the control contact is opened. When the control contact is closed again, the relay opens. Each time the control contact is closed, the relay changes status.

e. OFF DELAY



When the supply voltage is applied, the relay is open. When the control contact is closed, the relay closes. When the control contact opens, the time delay T begins. If the control contact is closed during timing, the time is reset and the relay remains closed. When the control contact opens, the time delay T starts again and opens when the relay closes.

f. SINGLE SHOT



When the supply voltage is applied, the relay is open. When the control contact is closed, the relay closes and the time delay T begins. Closing the control contact during timing is ignored.

g. WATCHDOG



When the supply voltage is applied, the relay is open. When the control contact is closed, the relay closes and the time delay T begins. Closing the control contact during timing triggers a new time delay T - the relay closing time is thus increased.

h. PULSE GENERATOR 0.5 s

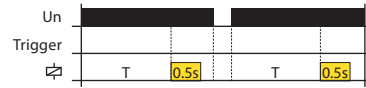

After the supply voltage has been applied, the time delay T begins. When the timing is complete, the relay closes for a fixed time (0.5 s).

PULSE GENERATOR 0.5 s with Inhibit

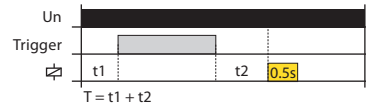

After supply voltage starts the time delay T. By closing timing of the control contact during timing is suspended. When the control contact opens, the time interval is completed and the relay closes for a fixed time (0.5 s).

i. INTERVAL ON/OFF



When the supply voltage is applied, the relay is open. When the control contact is closed, the relay closes and the time delay T begins. When the control contact is opened, the relay closes and the time delay T begins. If the control contact is open during timing, the relay remains closed for 2T. When the timing is complete, the relay opens. Any other change of control contact status during timing is ignored.

j. ON/OFF DELAY



When the supply voltage is applied, the relay is open. If control contact is closed, time delay T starts. When the control contact is opened, a new time delay T begins. If the control contact is open during timing, the relay closes at the end of the timing and opens the relay after the new time delay. Any other change of control contact status during timing is ignored.



EAN code  
CRM-131H/UNI: 8595188175562

## Technical parameters

## CRM-131H

### Power supply

Supply terminals:	A1 - A2
Voltage range:	AC/DC 12 - 240 V (AC 50-60 Hz)
Power input (max.):	2 VA/1.5W
Supply voltage tolerance:	-15 %; +10 %
Supply indication:	green LED

### Time circuit

Number of functions:	11
Time ranges:	50 ms - 30 days
Time setting:	rotary switch and potentiometer
Time deviation*:	5 % - mechanical setting
Repeat accuracy:	0.2 % - set value stability
Temperature coefficient:	0.01 %/°C, at = 20 °C (0.01 %/°F, at = 68 °F)

### Output

Number of contacts	1x changeover/SPDT (AgNi)
Current rating:	16 A/AC1; 1 HP 240 Vac, 1/2 HP 120 Vac; PD. B300
Breaking capacity:	4000 VA/AC1, 384 W/DC
Switching voltage:	250 V AC/24 V DC
Max. power dissipation:	1.2 W
Output indication:	multifunction red LED
Mechanical life:	10.000.000 ops.
Electrical life (AC1):	100.000 ops.

### Control

Load between I, S, R - A2:	Yes
Control terminals:	I, S, R - A1
Impulse length:	min. 25 ms/max. unlimited
Reset time:	max. 150 ms

### Other information

Operating temperature:	-20 .. +55 °C (-4 .. 131 °F)
Storage temperature:	-30 .. +70 °C (-22 .. 158 °F)
Dielectric strength:	4 kV AC (supply - output)
Operating position:	any
Mounting:	DIN rail EN 60715
Protection degree:	IP40 from front panel/IP20 terminals
Overvoltage category:	III.
Pollution degree:	2
Max. cable size (mm <sup>2</sup> ):	solid wire max. 1x 2.5 or 2x 1.5/ with sleeve max. 1x 2.5 (AWG 12)
Dimensions:	90 x 17.6 x 64 mm (3.5" x 0.7" x 2.5")
Weight:	61 g (2.2 oz.)
Standards:	EN 61812-1

\* for adjustable delay <100 ms, a time deviation of ± 10 ms applies

- Multifunction time relay for universal use in automation, control and regulation or in house installations.
- Three control inputs - START, INHIBIT, RESET.
- Mode selection - according to the set function, permanently closed, permanently open, function of MEMORY LATCH with delay.
- Multifunction red LED flashes or shines depending on the operating status.

## Description

Supply terminals  
(A1 - A2)

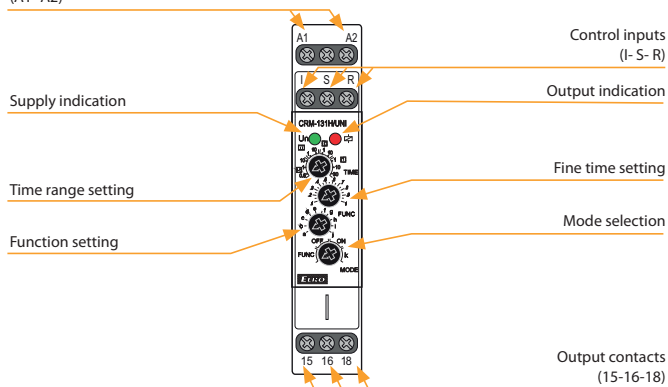

## Connection

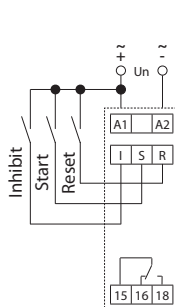

## Indication of operating states

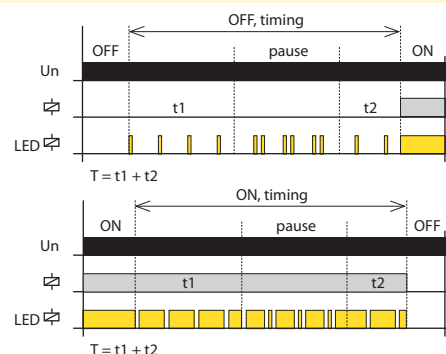

## Mode selection

### FUNC. Settings function mode

The desired function a-j is set with the FUNC rotary switch.

### OFF. Output contact open mode



### ON. Output contact closed mode



### k. MEMORY LATCH with delay

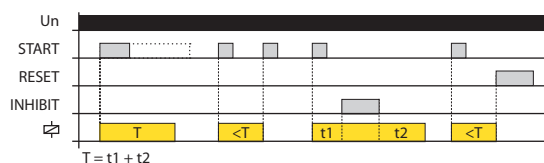

When the supply voltage is applied, the relay is open. If the START control contact is closed, the relay closes and the time delay T starts. It does not matter the length of the control pulse. When the timing is complete, the relay opens. If the START control contact is closed during timing, the relay opens immediately. Each time the control contact is closed during relay timing, it changes status. Closing the INHIBIT control contact pauses the timing, after opening the INHIBIT control contact the timing continues from the moment of interruption. Closing the RESET control contact immediately ends the timing and the relay opens, just like as when the supply voltage is disconnected.



Function

Control input function description:

- Contact START starts the time function
- INHIBIT contact pauses timing (pause)
- The RESET contact simulates switching the supply voltage on and off

Same for all features:

- If the control contact START is closed and the supply voltage is connected, the time function is activated when the supply voltage is connected.
- Closing the control contact INHIBIT pauses the timing, after opening the control contact INHIBIT timing continues from the moment of interruption.
- If the INHIBIT control contact is closed, the START control contact is activated and the timing is paused.
- Closing the control contact RESET immediately terminates the timing and the relay opens, just as when the supply voltage is disconnected.
- If the control contact RESET is closed and then the control contact START is closed, the time function is activated when the control contact RESET is opened as well as when the supply voltage is connected.

a. ON DELAY with Control Signal

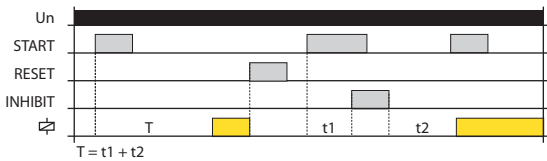

When the supply voltage is applied, the relay is open. If the control contact START is closed, the time delay T starts. The closing of the START control contact during timing is ignored.

b. INTERVAL ON with Control Signal

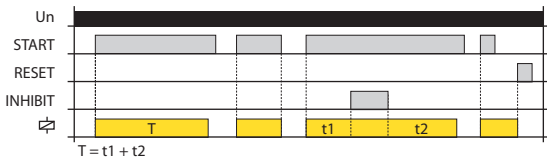

When the supply voltage is applied, the relay is open. When the control contact START is closed, the relay closes and the time delay T begins. If the START control contact is open during timing, the time interval is immediately terminated and the relay opens.

c. FLASHER - ON first with Control Signal

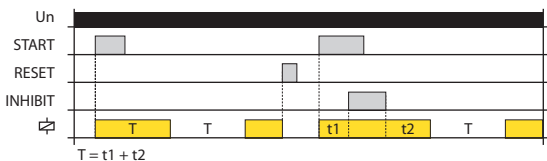

When the supply voltage is applied, the relay is open. When the START control contact is closed, the relay energizes and starts the delay time T. After the end of the timing relay opens and again runs delay time T. Upon completion timing again switches, and the sequence is repeated until the supply voltage is disconnected.

d. FLASHER - OFF first with Control Signal

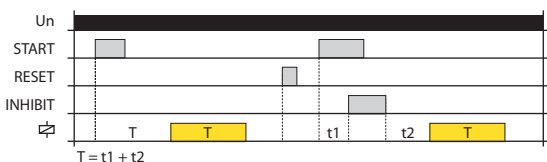

When the supply voltage is applied, the relay is open. When the START control contact is closed, starts the time delay T. After the end of the timing relay closes and again runs delay time T. After the end of the timing relay opens and the sequence is repeated until the supply voltage is disconnected.

e. OFF DELAY

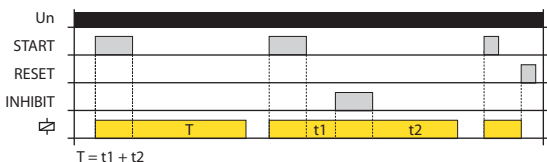

When the supply voltage is applied, the relay is open. If the control contact START is closed, the relay closes. After tripping Contact Start starts the delay time T. After the end of the timing relay is switched off.

f. SINGLE SHOT

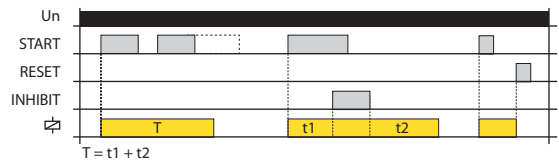

When the supply voltage is applied, the relay is open. When the START control contact is closed, the relay energizes and starts the delay time T. After the end of the timing relay is switched off. The closing of the START control contact during timing is ignored.

g. WATCHDOG

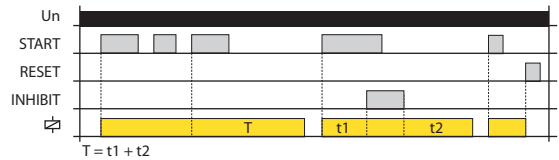

When the supply voltage is applied, the relay is open. When the START control contact is closed, the relay energizes and starts the delay time T. After the end of the timing relay is switched off. Closing control contact START during timing triggers a new time delay T - the relay closing time is thus increased.

h. PULSE GENERATOR 0.5 s with Control Signal

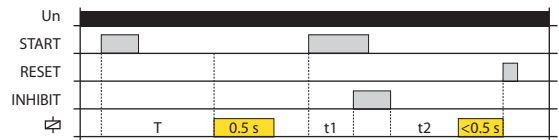

When the supply voltage is applied, the relay is open. When the START control contact is closed, starts the time delay T. After the end of the timing relay switches for the fixed time (0.5 sec).

i. INTERVAL ON/OFF

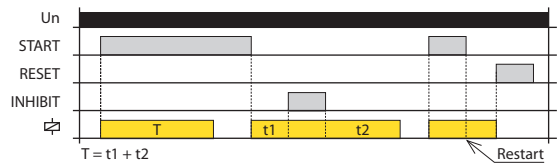

When the supply voltage is applied, the relay is open. When the START control contact is closed, the relay energizes and starts the delay time T. After the end of the timing relay is switched off. By opening the control contact start relay again closes and starts the delay time T. After the end of the timing relay is switched off.

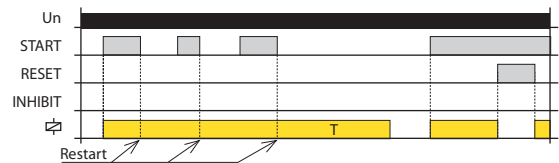

If the START control contact is open during timing, a restart occurs - the relay remains closed and a new time delay T begins. When the timing is complete, the relay opens.

j. ON/OFF DELAY

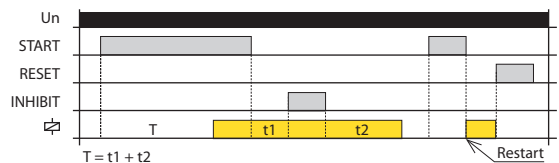

When the supply voltage is applied, the relay is open. When the START control contact is closed, starts the time delay T. After the end of the timing relay switches. Opening the control contact START starts a new time delay T. When the timing is complete, the relay opens.

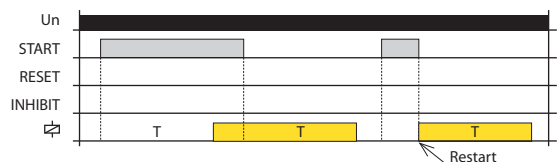

If the START control contact is open during timing, a restart occurs - the relay closes and a new time delay T begins. When the timing is complete, the relay opens.



EAN code  
CRM-82TO/UNI: 8595188137614

**Technical parameters CRM-82TO**

Number of functions:	a - TRUE OFF DELAY / e - ON DELAY
Supply terminals:	A1 - A2
Voltage range:	AC/DC 12 - 240 V (AC 50-60 Hz)
Burden (max.):	3 VA / 1.7 W
Max. dissipated power (Un + terminals):	2.5 W
Supply voltage tolerance:	-15 %; +10 %
Supply indication:	green LED
Time ranges:	0.1 s - 10 min
Time setting:	potentiometer
Time deviation:	5 % - mechanical setting
Repeat accuracy:	0.2 % - set value stability
Temperature coefficient:	0.1 %/°C, at = 20 °C (0.1 %/°F, at = 68 °F)

<b>Output</b>	
Number of contacts:	2x changeover/DPDT (AgNi/Silver Alloy)
Current rating:	8 A/AC1; 1/2 HP 240 Vac; PD. B300
Breaking capacity:	2000 VA/AC1, 192 W/DC
Inrush current:	10 A/<3 s
Switching voltage:	250 V AC/24 V DC
Output indication:	red LED
Mechanical life:	2.000.000 ops.
Electrical life (AC1):	200.000 ops.

<b>Other information</b>	
Operating temperature:	-20 .. 55 °C (-4 .. 131 °F)
Storage temperature:	-30 .. 70 °C (-22 .. 158 °F)
Dielectric strength:	4 kV (supply-output)
Operating position:	any
Mounting:	DIN rail EN 60715
Protection degree:	IP40 from front panel / IP10 terminals
Overvoltage category:	III.
Pollution degree:	2
Max. cable size (mm <sup>2</sup> ):	solid wire max. 2x 2.5 or 1x 4, with sleeve max. 2x 1.5 or 1x 2.5 (AWG 12)
Dimensions:	90 x 17.6 x 64 mm (3.5" x 0.7" x 2.5")
Weight:	73 g (2.6 oz.)
Standards:	EN 61812-1

- „TRUE OFF DELAY“ relay starts timing after power supply failure. Example of use case: back-up source for DELAY OFF in case power supply failure. (e.g. emergency lighting, emergency respirator, or protection of el. controlled doors - in case of fire).
- 2 time functions adjustable by rotary switch:  
a - delayed return after disconnecting of supply  
e - delayed start.
- Time range (adjustable by rotary switch and fine setting by potentiometer): 0.1 s - 10 min.
- Interruptions in the power supply must take time steps (tens to hundreds of milliseconds).
- Output status indicated by red LED (only in case of supply voltage connection).

**Description**

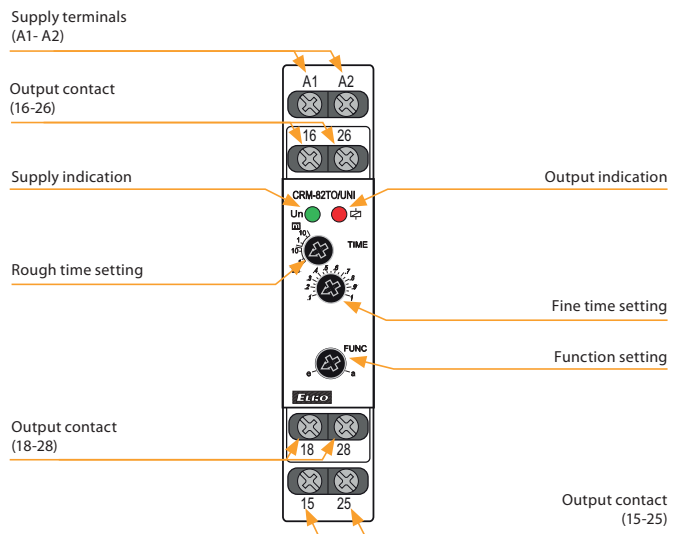

**Function**

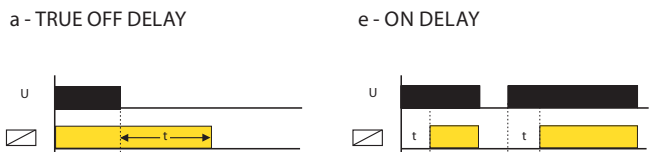

**Connection**

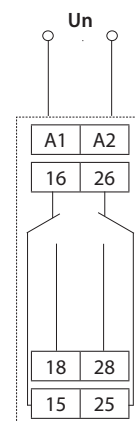

**Symbol**

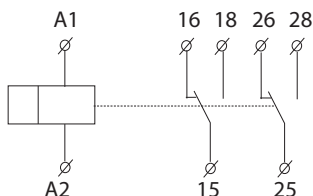



EAN code  
CRM-2T/230V: 8595188112291  
CRM-2T/UNI: 8595188112437

**Technical parameters CRM-2T**

**Power supply**

Supply terminals:	UNI	A1 - A2
Voltage range:	230	AC/DC 12 - 240 V (AC 50-60 Hz)
Power input (max.):		2 VA/1.5 W
Voltage range:		AC 230 V (50-60 Hz)
Power input (max.):		AC 3 VA/1.4 W
Supply voltage tolerance:		-15 %; +10 %
Supply indication:		green LED

**Function**

Time scale:	t1: 0.1 s - 100 days, t2: 0.1 s - 1 s
Time setting:	rotary switch and potentiometer
Time deviation:	5% - mechanical setting
Repeat accuracy:	0.2 % - set value stability
Temperature coefficient:	0.01 %/°C, at = 20 °C (0.01 %/°F, at = 68 °F)

**Output**

Number of contacts:	2x changeover/SPDT (AgNi)
Current rating:	16 A/AC1; 1 HP 240 Vac, 1/2 HP 120 Vac; PD. B300
Breaking capacity:	4000 VA/AC1, 384 W/DC
Inrush current:	30 A/< 3 s
Switching voltage:	250 V AC/24 V DC
Max. power dissipation:	1.2 W
Output indication:	multifunction red LED
Mechanical life:	10.000.000 ops.
Electrical life (AC1):	100.000 ops.
Reset time:	max. 150 ms

**Other information**

Operating temperature:	-20 .. 55 °C (-4 .. 131 °F)
Storage temperature:	-30 .. 70 °C (-22 .. 158 °F)
Dielectric strength:	
supply - output 1	4 kV AC
supply - output 2	4 kV AC
output 1 - output 2	4 kV AC
Operating position:	any
Mounting:	DIN rail EN 60715
Protection degree:	IP40 from front panel/IP20 terminals
Overvoltage category:	III.
Pollution degree:	2
Terminal wire capacity (mm²):	max.1x 2.5, 2x1.5, with sleeve max. 1x 2.5 (AWG 12)
Dimensions:	90 x 17.6 x 64 mm (3.5" x 0.7" x 2.5")
Weight:	UNI - 78 g (2.8 oz.), 230 - 73 g (2.6 oz.)
Standards:	EN 61812-1

**Symbol**

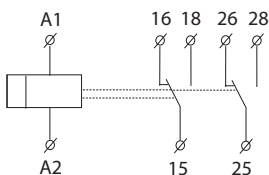

- It serves for delay ON of motors star/delta.
- Time t1 (star):
  - time range setting by rotary switch
  - fine time setting by potentiometer.
- Time t2 (delay) between λ/Δ
  - fine time setting by potentiometer.
- Multifunction red LED flashes or shines depending on the operating status.

**Description**

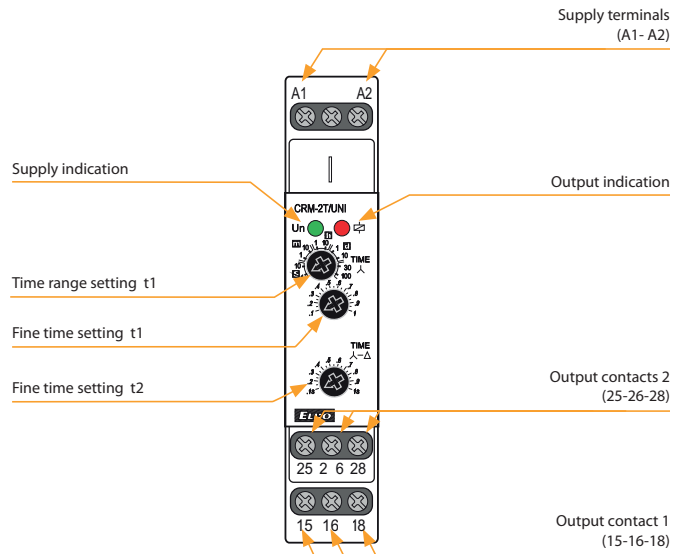

**Function**

**STAR/DELTA timer**

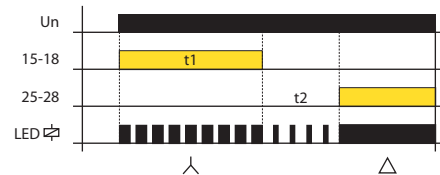

**Connection**

**Start up of motor (λ - Δ)**

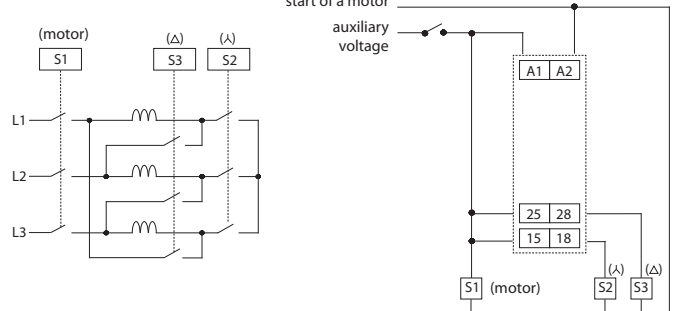



EAN code

CRM-181J/UNI ZR: 8595188180382  
CRM-181J/UNI ZN: 8595188180399  
CRM-181J/UNI BL: 8595188180405  
CRM-181J/UNI OD: 8595188180412

CRM-183J/UNI ZR: 8595188180610  
CRM-183J/UNI ZN: 8595188180603  
CRM-183J/UNI BL: 8595188180580  
CRM-183J/UNI OD: 8595188180597

Technical parameters	CRM-181J	CRM-183J
<b>Power supply</b>		
Supply terminals:	A1 - A2	
Voltage range:	AC/DC 12 - 240 V (AC 50-60 Hz)	
Power input (max.):	2 VA/1.5 W	2.5 VA/1.5 W
Supply voltage tolerance:	-15 %; +10 %	
Supply indication:	green LED	
<b>Time circuit</b>		
Time ranges:	0.1 s - 100 h	
Time setting:	rotary switch and potentiometer	
Time deviation:	5 % - mechanical setting	
Repeat accuracy:	0.2 % - set value stability	
Temperature coefficient:	0.01%/°C, at =20 °C (0.01 %/°F, at = 68°F)	
<b>Output</b>		
Output contact 1:	1x changeover/SPDT (AgNi)	
Current rating:	16 A/AC1; 1 HP 240 Vac, 1/2 HP 120 Vac; PD. B300	
Breaking capacity:	4000 VA/AC1, 384 W/DC	
Electrical life (AC1):	100.000 ops.	
Output contact 2 (3):	x	2x chang./DPDT (AgNi)
Current rating:	x	8 A/AC1; 1/2 HP 240Vac; PD. B300
Breaking capacity:	x	2000 VA/AC1, 192 W/DC
Electrical life (AC1):	x	50.000 ops.
Switching voltage:	250 V AC/24 V DC	
Max. power dissipation:	1.2 W	2.4 W
Output indication:	multifunction red LED	
Mechanical life:	10.000.000 ops.	
<b>Control</b>		
Control terminals:	A1-S	
Load between S-A2:	Yes	
Impulse length:	min. 25 ms/max. unlimited	
Reset time:	max. 150 ms	
<b>Other information</b>		
Operating temperature:	-20 .. +55 °C (-4 .. 131 °F)	
Storage temperature:	-30 .. +70 °C (-22 .. 158 °F)	
Dielectric strength:		
supply - output 1	4 kV AC	
supply - output 2 (3)	x	1 kV AC
output 1 - output 2	x	1 kV AC
output 2 - output 3	x	1 kV AC
Operating position:	any	
Mounting:	DIN rail EN 60715	
Protection degree:	IP40 from front panel/IP20 terminals	
Overvoltage category:	III.	
Pollution degree:	2	
Max. cable size (mm <sup>2</sup> ):	solid wire max. 1x 2.5 or 2x 1.5/ with sleeve max. 1x 2.5 (AWG 12)	
Dimensions:	90 x 17.6 x 64 mm (3.5" x 0.7" x 2.5")	
Weight:	61 g (2.2 oz.)	84 g (3 oz.)
Standards:	EN 61812-1	

- Single function time relays are suitable for applications where there is a clear function requirement in advance and are suitable for universal use in automation, control and regulation or in house installations.
- Choice of four types: ZR, ZN, BL, OD.
- All functions initiated by the supply voltage can use the control input to inhibit the ongoing delay (pause).
- Multifunction red LED flashes or shines depending on the operating status.

## Description

CRM-183J

Supply terminals  
(A1 - A2)

Control input (S)

Output contacts 3  
(35-36-38)

Supply indication

Output indication

Time range setting

Fine time setting

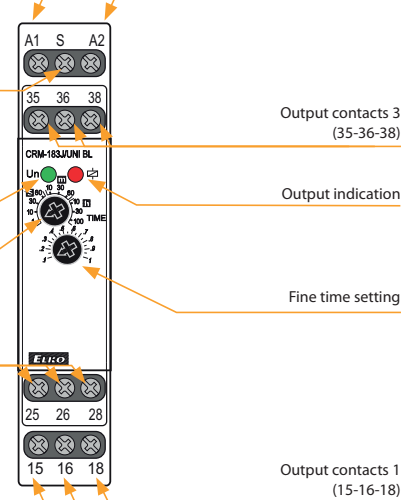
Output contacts 2  
(25-26-28)

## Connection

CRM-181J

CRM-183J

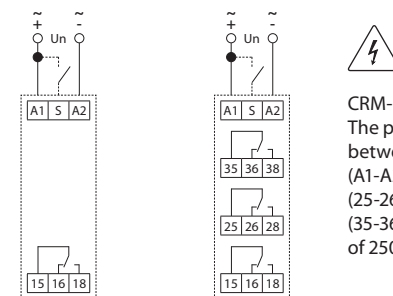

**CRM-183J:**  
The potential difference between the supply terminals (A1-A2), output contact 2 (25-26-28) and output contact 3 (35-36-38) must be a maximum of 250 V AC rms/DC.

## Possibility to connect load onto controlling input

It is possible to connect the load (e.g.: contactor) between terminals S-A2, without any interruption of correct relay function.

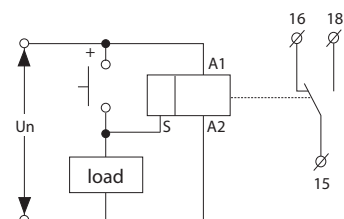



Indication of operating states

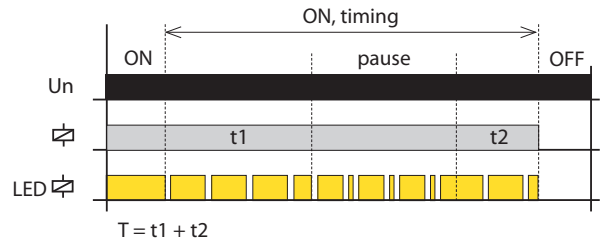
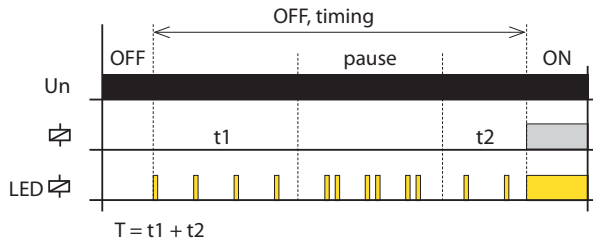

Function

ZR: ON DELAY

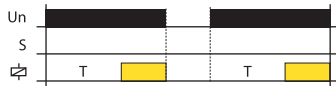

When the supply voltage is applied, the time delay T begins. When the timing is complete, the relay closes and this condition continues until the supply voltage is disconnected.

BL: FLASHER - ON first



If the control contact is closed and the supply voltage is connected, the relay will close and the timing will start only after the control contact has been opened. When the timing is complete, the relay opens.

ON DELAY with Inhibit

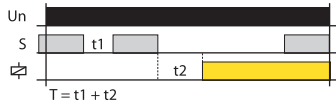

If the control contact is closed and the supply voltage is connected, the relay is opened and timing does not start until the control contact opens. When the timing is complete, the relay closes. If the control contact is closed during timing, the timing is interrupted and continues only after the control contact opens.

FLASHER - ON first with Inhibit

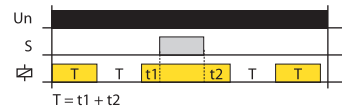

If the control contact is closed during an active timer setting, the timing is interrupted and continues only after the control contact opens again.

ZN: INTERVAL ON



After supply voltage relay closes and starts the delay time T. After the end of the timing relay opens and this state lasts until the supply voltage is disconnected.

OD: OFF DELAY



When the supply voltage is applied, the relay is open. When the control contact is closed, the relay closes. When the control contact opens, the time delay T begins. If the control contact is closed during timing, the time is reset and the relay remains closed. When the control contact opens, the time delay T starts again and opens when the relay closes.

INTERVAL ON with Inhibit

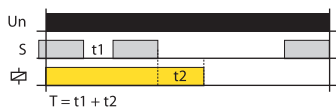

If the control contact is closed and the supply voltage is connected, the relay will close and the timing will start only after the control contact has been opened. When the timing is complete, the relay opens. If the control contact is closed during timing, the timing is interrupted and continues only after the control contact opens.

Note:

ZR, ZN and BL functions are initiated by connecting the supply voltage to the product, i.e. In the event of a failure and recovery of the supply voltage, the relay automatically performs 1 cycle.



EAN code  
CRM-2H/230V: 8595188124201  
CRM-2H/UNI: 8595188113007

Technical parameters		CRM-2H
<b>Power supply</b>		
Supply terminals:		A1 - A2
Voltage range:	UNI	AC/DC 12 - 240 V (AC 50-60 Hz)
Power input (max.):		2 VA/1.5 W
Voltage range:	230	AC 230 V (50/60 Hz)
Power input (max.):		AC 3 VA/1.4 W
Supply voltage tolerance:		-15 %; +10 %
Supply indication:		green LED
<b>Function</b>		
Time scale:		0.1 s - 100 days
Time setting:		rotary switch and potentiometer
Time deviation:		5 % - mechanical setting
Repeat accuracy:		0.2 % - set value stability
Temperature coefficient:		0.01 %/°C, at = 20°C (0.01 %/°F, at = 68°F)
<b>Output</b>		
Number of contacts:		1x changeover/SPDT (AgNi)
Current rating:		16 A/AC1; 1 HP 240 Vac, 1/2 HP 120 Vac; PD. B300
Breaking capacity:		4000 VA/AC1, 384 W/DC
Inrush current:		30 A/< 3 s
Switching voltage:		250 V AC/24 V DC
Max. power dissipation:		1.2 W
Output indication:		multifunction red LED
Mechanical life:		10.000.000 ops.
Electrical life (AC1):		100.000 ops.
Reset time:		max. 150 ms
<b>Other information</b>		
Operating temperature:		-20 .. 55 °C (-4 .. 131 °F)
Storage temperature:		-30 .. 70 °C (-22 .. 158 °F)
Dielectric strength:		4 kV AC (supply - output)
Operating position:		any
Mounting:		DIN rail EN 60715
Protection degree:		IP40 from front panel/IP20 terminals
Overvoltage category:		III.
Pollution degree:		2
Terminal wire capacity (mm <sup>2</sup> ):		solid wire max. 1x 2.5 or 2x 1.5/ with sleeve max. 1x 2.5 (AWG 12)
Dimensions:		90 x 17.6 x 64 mm (3.5" x 0.7" x 2.5")
Weight		UNI - 61 g (2.2 oz.), 230 - 58 g (2 oz.)
Standards:		EN 61812-1

### Symbol

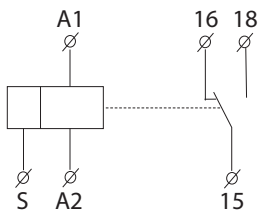

- Flasher with independent adjustable switch ON and switch OFF.
- Used for regular room ventilation, cyclic dehumidification, light control, circulating pumps, illuminated advertising, etc.
- 2 time functions:
  - 1) Asymmetric FLASHER - ON first
  - 2) Asymmetric FLASHER - OFF first
- Function choice is done by an external jumper of terminals S-A1.
- Time scale 0.1 s - 100 days divided into 10 time ranges.
- Time range setting via rotary switch.
- Fine time setting by potentiometer.
- Multifunction red LED flashes or shines depending on the operating status.

### Description

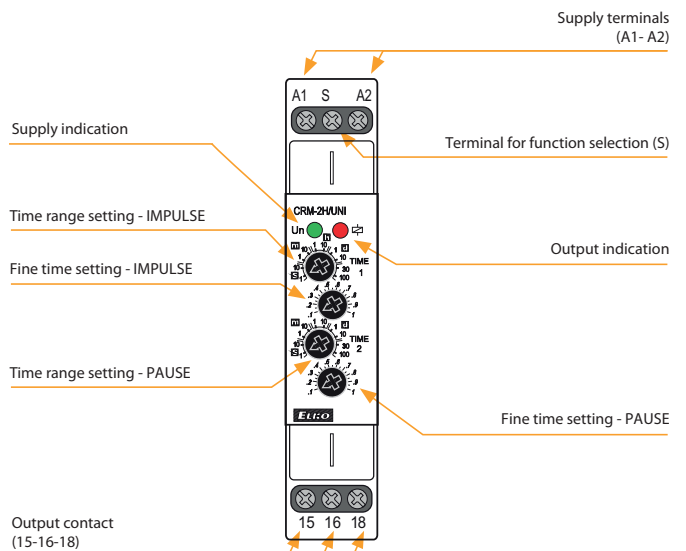

### Connection

#### Asymmetric FLASHER - ON first



#### Asymmetric FLASHER - OFF first (jumper S-A1)

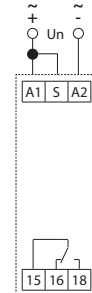

### Function

#### Asymmetric FLASHER - ON first

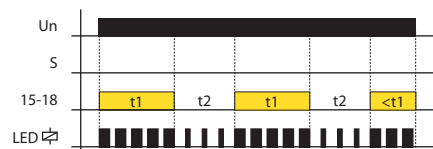

#### Asymmetric FLASHER - OFF first

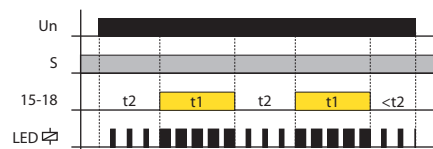



EAN code  
 CRM-2HE/UNI: 8595188124553  
 CRM-2HE/UNI + 2X potentiometer: 8595188142069  
 Potentiometer: 859232367981

- Control by external control unit - potentiometer (can be placed/ mounted for example on switch board doors or in panel).
- Asymmetric cycler - 2 time functions:  
 - flasher beginning with pulse  
 - flasher beginning with gap.
- Function selected via external wired link on control input S-A1.
- Possible to connect external potentiometer - max. distance 10 m (32.8 ft.) from relay.

Technical parameters	CRM-2HE
Number of functions:	2
Supply terminals:	A1 - A2
Supply voltage:	AC/DC 12 - 240 V (AC 50-60 Hz)
Consumption (max.):	3 VA / 1.7 W
Max. dissipated power:	4 W (Un + terminals)
Supply voltage tolerance:	-15 %; +10 %
Supply indication:	green LED
Time ranges:	0.1 s - 100 days
Time setting:	rotary switch, external potentiometer
Time deviation:	5 % - mechanical setting
Repeat accuracy:	0.2 % - set value stability
Temperature coefficient:	0.01 %/°C, at = 20°C (0.01%/°F, at = 68°F)
<b>Output</b>	
Contact type:	1x changeover/SPDT (AgNi/Silver Alloy)
Current rating:	16 A/AC1; 1 HP 240 Vac, 1/2 HP 120 Vac; PD. B300
Breaking capacity:	4000 VA/AC1, 384 W/DC1
Inrush current:	30 A/<3 s
Switching voltage:	250 V AC/24 V DC
Output indication:	multifunction red LED
Mechanical life:	10.000.000 ops.
Electrical life (AC1):	100.000 ops.
<b>Controlling</b>	
Control voltage:	AC/DC 12 - 240 V (AC 50-60 Hz)
Consumption of input:	AC 0.025-0.2 VA/DC 0.1-0.7 W
Load between S-A2:	Yes
Glow-tubes:	No
Control terminals:	A1-S
Reset time:	max. 150 ms
<b>Other information</b>	
Operating temperature:	-20 .. +55 °C (-4 .. 131 °F)
Storage temperature:	-30 .. +70 °C (-22 .. 158 °F)
Dielectric strength:	AC 4 kV (supply - output)
Operating position:	any
Mounting:	DIN rail EN 60715
Protection degree:	IP40 front panel / IP20 terminals
Overvoltage category:	III.
Pollution degree:	2
Cross-wire section - solid/ stranded with ferrule (mm²):	max. 1x 2.5, 2x 1.5/ max. 1x 2.5 (AWG 12)
Dimensions:	90 x 17.6 x 64 mm (3.5" x 0.7" x 2.5")
Weight:	78 g (2.8 oz.)
Standards:	EN 61812-1

Potentiometer	
Potentiometer:	10 - 150 kΩ, linear
Protection degree:	IP65 from front side/IP20 from back side
Max. cable size (mm²):	1.5 with sleeve/without sleeve max. 2.5 (AWG 12)
Weight:	16 g (0.6 oz.)
Dimensions:	see page Accessories

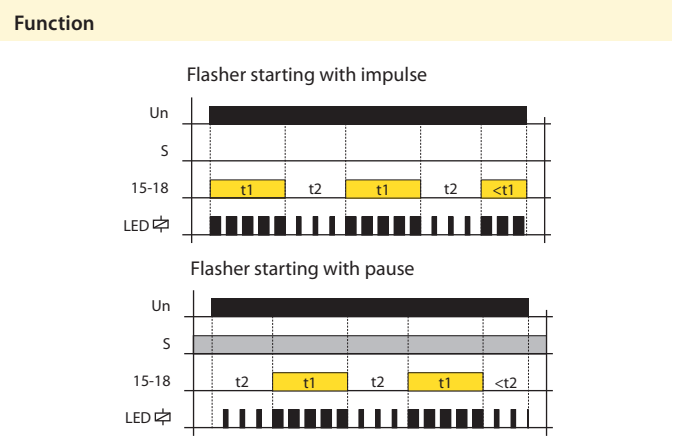
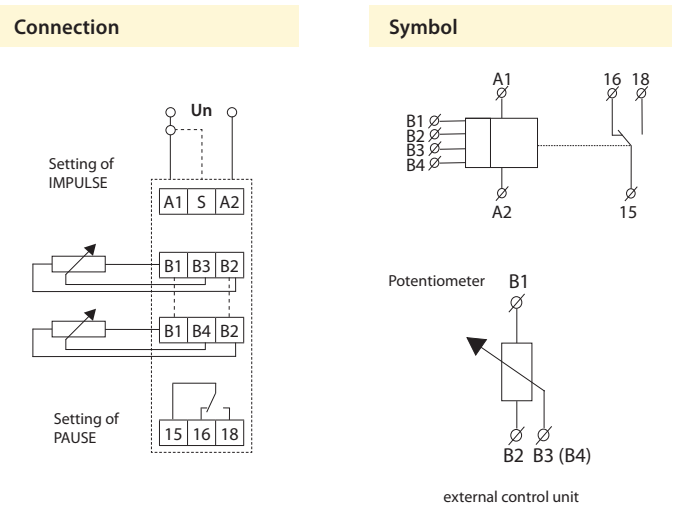
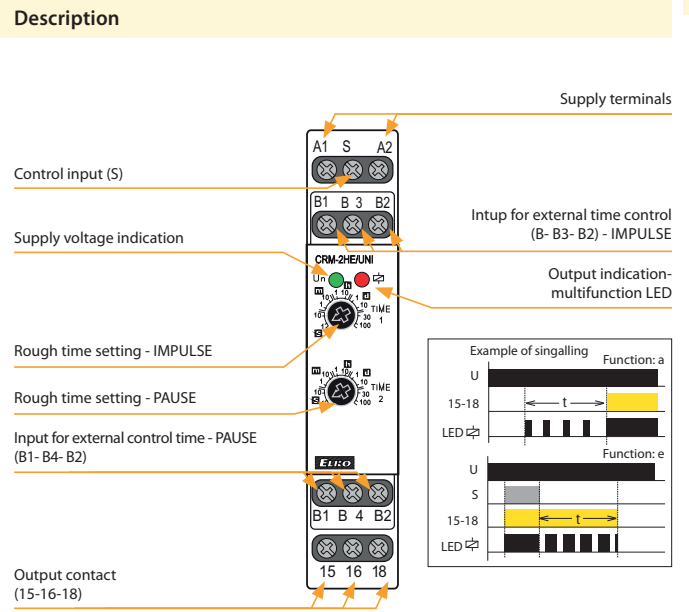



EAN code  
SJR-2/230V: 8595188116015  
SJR-2/UNI: 8595188117401

## Technical parameters SJR-2

### Power supply

Supply terminals:	A1 - A2
Voltage range:	AC/DC 12 - 240 V (AC 50-60 Hz)
Power input (max.):	UNI 2.5 VA/1.5 W
Voltage range:	AC 230 V (50-60 Hz)
Power input (max.):	230 4 VA/2 W
Supply voltage tolerance:	-15 %; +10 %
Supply indication:	green LED

### Function

Time ranges:	0.1 s - 10 days
Time setting:	rotary switch and potentiometer
Time deviation:	5 % - mechanical setting
Repeat accuracy:	0.2 % - set value stability
Temperature coefficient:	0.01 %/°C, at = 20 °C (0.01 %/°F, at = 68 °F)

### Output

Number of contacts:	2x changeover/DPDT (AgNi)
Current rating:	16 A/AC1; 1 HP 240 Vac, 1/2 HP 120 Vac; PD. B300
Breaking capacity:	4000 VA/AC1, 384 W/DC
Inrush current:	30 A/< 3 s
Switching voltage:	250 V AC/24 V DC
Max. power dissipation:	2.4 W
Output indication:	multifunction red LED
Mechanical life:	10.000.000 ops.
Electrical life (AC1):	100.000 ops.
Reset time:	max. 150 ms

### Other information

Operating temperature:	-20 .. 55 °C (-4 .. 131 °F)
Storage temperature:	-30 .. 70 °C (-22 .. 158 °F)
Dielectric strength:	
supply - output 1	4 kV AC
supply - output 2	4 kV AC
output 1 - output 2	4 kV AC
Operating position:	any
Mounting:	DIN rail EN 60715
Protection degree:	IP40 from front panel/IP20 terminals
Overvoltage category:	III.
Pollution degree:	2
Max. cable size (mm <sup>2</sup> ):	solid wire max. 1x 2.5 or 2x1.5/ with sleeve max. 1x 2.5 (AWG 12)
Dimensions:	90 x 17.6 x 64 mm (3.5" x 0.7" x 2.5")
Weight:	UNI - 78 g (2.8 oz.), 230 - 75 g (2.6 oz.)
Standards:	EN 61812-1

### Symbol

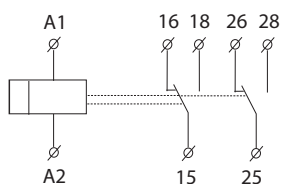

- For gradual switching of high power, prevents current strokes in the main.
- Double stage ON DELAY.
- Time scale 0.1 s - 10 days divided into 10 ranges:  
0.1 s - 1 s/1 s - 10 s/0.1 min - 1 min/1 min - 10 min/0.1 hrs - 1 h/1 h - 10 hrs/0.1 day - 1 day/1 day - 10 days/only ON/only OFF.
- Times t1 and t2 are independantly adjustable.
- Time range setting via rotary switch.
- Voltage range: AC 230 V or AC/DC 12 - 240 V.
- Output contact: 2 x changeover/DPDT 16 A.
- Multifunction red LED flashes or shines depending on the operating status.

## Description

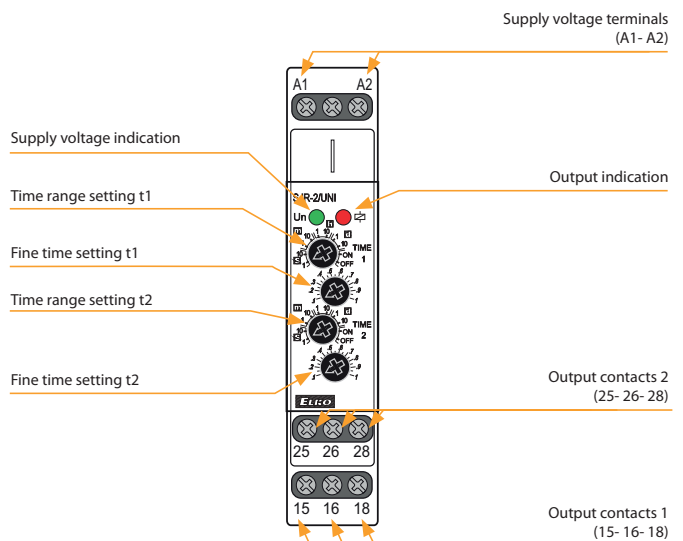

## Connection

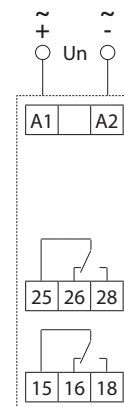

## Function

### 2x ON DELAY

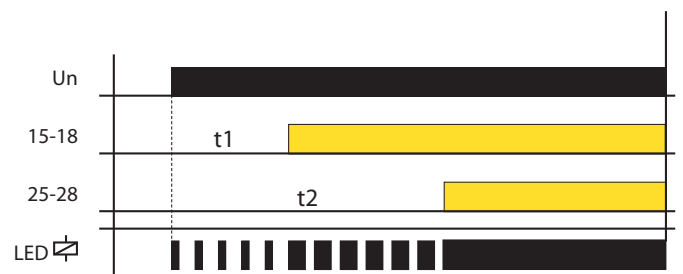



EAN code  
 PTRM-216TP/UNI: 8595188179386  
 PTRM-216KP/UNI: 8595188178617

- Multifunction time relay for universal use in automation, control and regulation or in house installations.
- Possibility to select the control element for fine time setting:  
**PTRM-216KP** - knob, for easy handling without the need for tools  
**PTRM-216TP** - rotary switch, for the possibility of using a sealable cover.
- All functions initiated by the supply voltage, except for the flasher function, can use the control input to inhibit the delay (pause).
- Mode selection - according to the set function, permanently closed, permanently open, and switching of the second output contact according to the supply voltage.
- Multifunction red LED flashes or shines depending on the operating status.

Technical parameters	PTRM-216TP	PTRM-216KP
<b>Power supply</b>		
Power pins:	2, 10	
Voltage range:	AC/DC 12 – 240 V (AC 50-60 Hz)	
Power input (max.):	2.5 VA/1.5 W	
Supply voltage tolerance:	±10 %	
Supply indication:	green LED	
<b>Time circuit</b>		
Number of functions:	10	
Time ranges:	50 ms - 30 days	
Time setting:	rotary switch and potentiometer	
Time deviation:*	5 % - mechanical setting	
Repeat accuracy:	0.2 % - set value stability	
Temperature coefficient:	0.01 %/°C, at = 20 °C (0.01 %/°F, at = 68 °F)	
<b>Output</b>		
Number of contacts:	2x changeover/SPDT (AgNi)	
Current rating:	16 A/AC1; 1 HP 240 Vac, 1/2 HP 120 Vac; PD. B300	
Breaking capacity:	4000 VA/AC1, 384 W/DC	
Switching voltage:	250 V AC/24 V DC	
Max. power dissipation:	2.4 W	
Output indication:	multifunction red LED	
Mechanical life:	10.000.000 ops.	
Electrical life (AC1):	100.000 ops.	
<b>Control</b>		
Control pins:	5 (2)-6	
Impulse length:	min. 25 ms/max. unlimited	
Reset time:	max. 150 ms	
<b>Other information</b>		
Operating temperature:	-20 .. +55 °C (-4 .. 131 °F)	
Storage temperature:	-30 .. +70 °C (-22 .. 158 °F)	
Dielectric strength:		
supply - output 1 (1, 3, 4)	2.5 kV AC	
supply - output 2 (8, 9, 11)	2.5 kV AC	
output 1 - output 2	2.5 kV AC	
Operating position:	any	
Mounting:	11 pin octal socket	
Protection degree:	IP40 from front panel	
Overvoltage category:		
for supply voltage 12-150 V AC/DC	III.	
for supply voltage 150-240 V AC/DC	II.	
Pollution degree:	2	
Dimensions:	48x48x79mm (1.7" x1.7" x3.1")	48x48x89mm (1.7" x1.7" x3.5")
Weight:	111 g (3.9 oz.)	108 g (3.81 oz.)
Standards:	EN 61812-1	

\* for adjustable delay <100 ms, a time deviation of ± 10 ms applies

**Function**

Functions (page 23).

**Description**

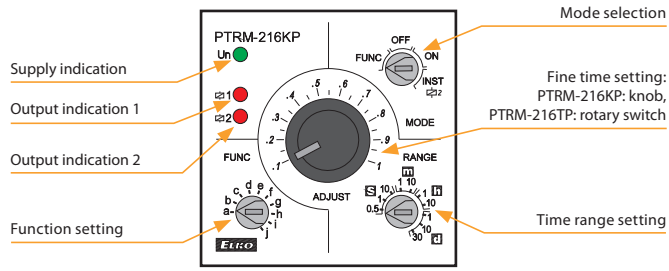

**Connection**      **Indication of operating states**

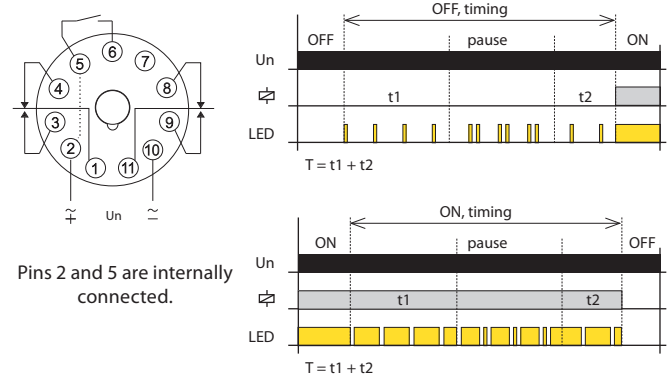

**Mode selection**

**FUNC. Settings function mode**  
 The desired function a-j is set with the FUNC rotary switch.

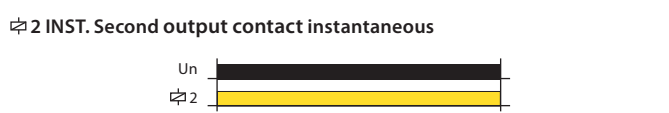

The second output contact switches according to the supply voltage. The first output contact switches according to the function (a-j) set by the trimmer FUNC.





EAN code  
 PTRM-216T/UNI: 8595188175586  
 PTRM-216K/UNI: 8595188175579

Technical parameters	PTRM-216T	PTRM-216K
<b>Power supply</b>		
Power pins:	2, 10	
Voltage range:	AC/DC 12 – 240 V (AC 50-60 Hz)	
Power input (max.):	2.5 VA/1.5 W	
Supply voltage tolerance:	± 10 %	
Supply indication:	green LED	
<b>Time circuit</b>		
Number of functions:	10	
Time ranges:	50 ms - 30 days	
Time setting:	rotary switch and potentiometer	
Time deviation*:	5 % - mechanical setting	
Repeat accuracy:	0.2 % - set value stability	
Temperature coefficient:	0.01 %/°C, at = 20 °C (0.01 %/°F, at = 68 °F)	
<b>Output</b>		
Number of contacts:	2x changeover/SPDT (AgNi)	
Current rating:	16 A/AC1; 1 HP 240 Vac, 1/2 HP 120 Vac; PD. B300	
Breaking capacity:	4000 VA/AC1, 384 W/DC	
Switching voltage:	250 V AC/24 V DC	
Max. power dissipation:	2.4 W	
Output indication:	multifunction red LED	
Mechanical life:	10.000.000 ops.	
Electrical life (AC1):	100.000 ops.	
<b>Control</b>		
Control pins:	5 - 6	
Impulse length:	min. 25 ms/max. unlimited	
Reset time:	max. 150 ms	
<b>Other information</b>		
Operating temperature:	-20 .. +55 °C (-4 ..131 °F)	
Storage temperature:	-30 .. +70 °C (-22 .. 158 °F)	
Dielectric strength:		
supply - output 1 (1, 3, 4)	2.5 kV AC	
supply - output 2 (8, 9, 11)	2.5 kV AC	
output 1 - output 2	2.5 kV AC	
Operating position:	any	
Mounting:	11 pin octal socket	
Protection degree:	IP40 from front panel	
Overvoltage category:		
for supply voltage	12-150V AC/DC III.	
for supply voltage	150-240V AC/DC II.	
Pollution degree:	2	
Dimensions:	48x48x79mm (1.7"x1.7"x3.1")	48x48x89mm (1.7"x1.7"x3.5")
Weight:	111 g (3.9 oz.)	108 g (3.81 oz.)
Standards:	EN 61812-1	

\* for adjustable delay <100 ms, a time deviation of ± 10 ms applies

**Function**  
 Functions (page 23).

- Multifunction time relay for universal use in automation, control and regulation or in house installations.
- Potential-free control input (Control Switch Trigger).
- Possibility to select the control element for fine time setting:
- **PTRM-216K** - knob, for easy handling without the need for tools.
- **PTRM-216T** - rotary switch, for the possibility of using a sealable cover.
- All functions initiated by the supply voltage, except for the flasher function, can use the control input to inhibit the delay (pause).
- Mode selection - according to the set function, permanently closed, permanently open, and switching of the second output contact according to the supply voltage.
- Multifunction red LED flashes or shines depending on the operating status.

**Description**

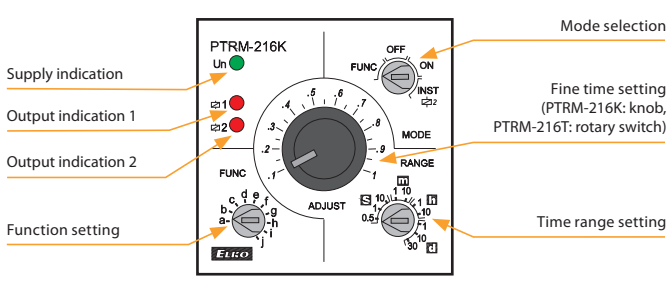

**Connection**      **Indication of operating states**

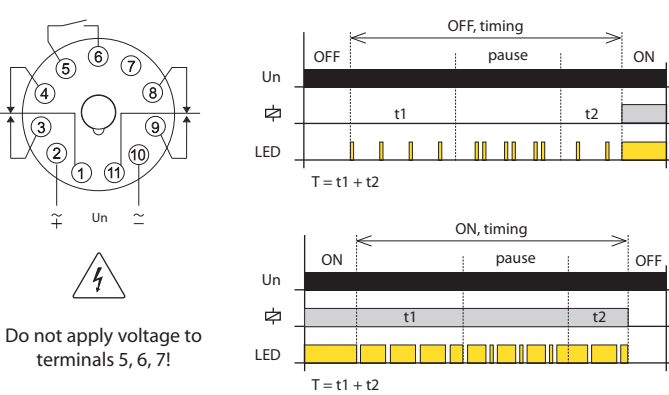

**Mode selection**

**FUNC. Settings function mode**  
 The desired function a-j is set with the FUNC rotary switch.

**OFF. Output contact open mode**



**ON. Output contact closed mode**



**⚡ 2 INST. Second output contact instantaneous**



The second output contact switches according to the supply voltage. The first output contact switches according to the function (a-j) set by the trimmer FUNC.



EAN code  
 PTRA-216T/UNI: 8595188175609  
 PTRA-216K/UNI: 8595188175593

Technical parameters	PTRA-216T	PTRA-216K
<b>Power supply</b>		
Power pins:	2, 10	
Voltage range:	AC/DC 12 – 240 V (AC 50-60 Hz)	
Power input (max.):	2.5 VA/1.5 W	
Supply voltage tolerance:	±10 %	
Supply indication:	green LED	
<b>Time circuit</b>		
Number of functions:	10	
Time ranges:	50 ms - 30 days	
Time setting:	rotary switch and potentiometer	
Time deviation*:	5 % - mechanical setting	
Repeat accuracy:	0.2 % - set value stability	
Temperature coefficient:	0.01 %/°C, at = 20 °C (0.01 %/°F, at = 68 °F)	
<b>Output</b>		
Number of contacts:	2x changeover/SPDT (AgNi)	
Current rating:	16 A/AC1; 1 HP 240 Vac, 1/2 HP 120 Vac; PD. B300	
Breaking capacity:	4000 VA/AC1, 384 W/DC	
Switching voltage:	250 V AC/24 V DC	
Max. power dissipation:	2.4 W	
Output indication:	multifunction red LED	
Mechanical life:	10.000.000 ops.	
Electrical life (AC1):	100.000 ops.	
<b>Control</b>		
Control pins:	5 - 2, 6 - 2, 7 - 2	
Impulse length:	min. 25 ms/max. unlimited	
Reset time:	max. 150 ms	
<b>Other information</b>		
Operating temperature:	-20 .. +55 °C (-4 .. 131 °F)	
Storage temperature:	-30 .. +70 °C (-22 .. 158 °F)	
Dielectric strength:		
supply - output 1 (1, 3, 4)	2.5 kV AC	
supply - output 2 (8, 9, 11)	2.5 kV AC	
output 1 - output 2	2.5 kV AC	
Operating position:	any	
Mounting:	11 pin octal socket	
Protection degree:	IP40 from front panel	
Overvoltage category:		
for supply voltage	12-150V AC/DC III.	
for supply voltage	150-240V AC/DC II.	
Pollution degree:	2	
Dimensions:	48x48x79mm (1.7"x1.7"x3.1")	48x48x89mm (1.7"x1.7"x3.5")
Weight:	111 g (3.9 oz.)	108 g (3.81 oz.)
Standards:	EN 61812-1	

\* for adjustable delay <100 ms, a time deviation of ± 10 ms applies

**Function**

Functions (page 25).

- Multifunction time relay for universal use in automation, control and regulation or in house installations.
- Three control inputs - START, INHIBIT, RESET.
- Possibility to select the control element for fine time setting:  
**PTRA-216K** - knob, for easy handling without the need for tools  
**PTRA-216T** - rotary switch, for the possibility of using a sealable cover.
- Mode selection - according to the set function, permanently closed, permanently open, and switching of the second output contact according to the supply voltage.
- Multifunction red LED flashes or shines depending on the operating status.

**Description**

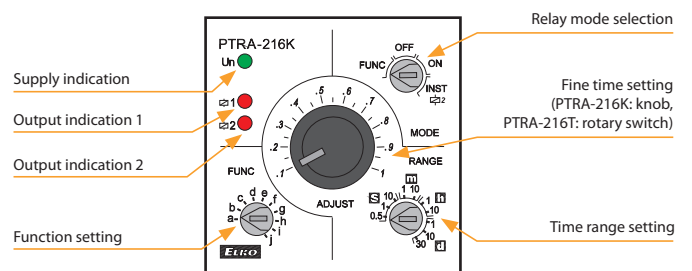

**Connection**

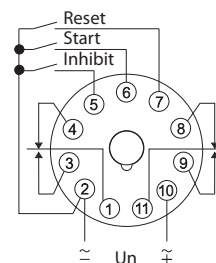

**Indication of operating states**

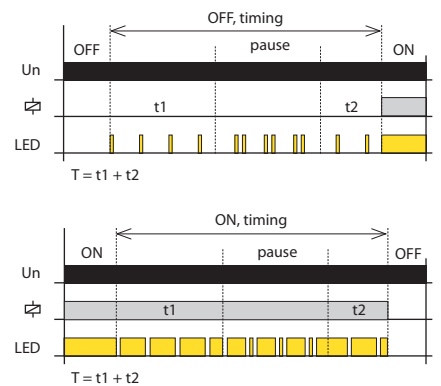

**Mode selection**

**FUNC. Settings function mode**

The desired function a-j is set with the FUNC rotary switch.

**OFF. Output contact open mode**



**ON. Output contact closed mode**



**ϕ 2 INST. Second output contact instantaneous**



The second output contact switches according to the supply voltage. The first output contact switches according to the function (a-j) set by the trimmer FUNC.



EAN code  
CRM-100: 8595188174534

### Technical parameters

### CRM-100

Number of functions:	17
Supply terminals:	A1 - A2
Voltage range:	AC/DC 24-240 V (50-60 Hz)
Consumption (max):	4 VA / 3 W
Max. dissipated power (Un + terminals):	4 W
Supply voltage tolerance:	-15 %; +10 %
Time ranges:	0.1 s - 999 hrs.
Time setting:	Buttons SET/ADJ
Repeat accuracy:	± 0.5 % - of selected range
Variation in timing due to voltage change:	± 2%
Variation in timing due to temperature change:	± 5%

### Output

Number of contacts:	1x changeover / SPDT (AgNi)
Current rating:	8 A/AC1
Breaking capacity:	2000 VA/AC1, 192 W/DC
Inrush current:	10 A/<3 s
Switching voltage:	250 V AC/24 V DC
Output indication:	multifunction red LED
Mechanical life:	20.000.000 ops.
Electrical life (AC1):	100.000 ops.

### Controlling

Control terminals:	A1-B1
--------------------	-------

### Other information

Operating temperature:	-10 .. +55 °C (14 .. 131 °F)
Storage temperature:	-30 .. +70 °C (-22 .. 158 °F)
Isolation (Between Input and Output):	2.5 kV
Operating position:	any
Mounting:	DIN rail EN 60715
Protection degree:	IP30 from front panel/IP20 terminals
Overvoltage category:	III.
Pollution degree:	2
Max. cable size (mm <sup>2</sup> ):	solid wire max. 1x 2.5 or 2x 1.5/ with sleeve max. 1x 2.5 (AWG 12)
Dimensions:	85 x 18.2 x 76 mm (3.3" x 0.7" x 2.99")
Weight:	78 g (2.8 oz.)
Standards:	EN 61812-1

### Symbol

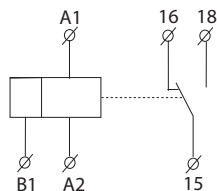

- Digital multifunction relay can be used for controlling lights, heating, motors, pumps, machines and appliances where you need set time functions.
- 17 most used functions.
- Thanks to digital display and settings you exact set required time (without any mechanical tolerance).
- Time range 0.1 s - 999 hours.
- Universal power supply 24 - 240 V AC/DC brings you variability of powering.
- Visible time function for non-authorized.

### Description

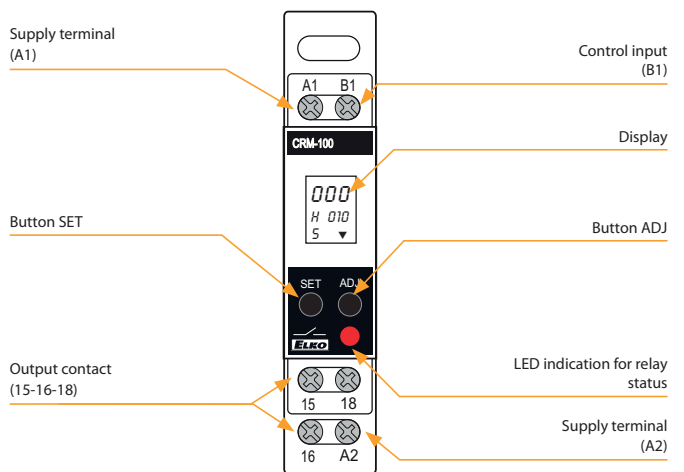

### Description of displayed elements on the screen

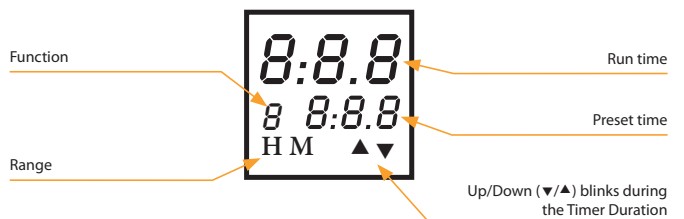

### Connection

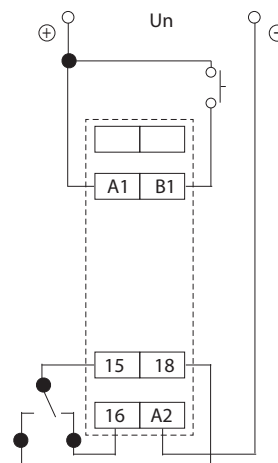

Function

- 0**



**ON delay [7]**  
Timing commences when supply is present. R energizes at the end of the timing period.

**A**



**Impulse ON/OFF [8]**  
Permanent supply is required. R energizes for the timing period when B1 is opened or closed. When timing commences, changing state of B1 does not affect R but resets timer.
- 1**

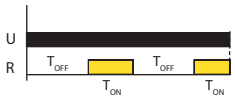

**Cyclic OFF/ON {OFF Start, (Sym, Asym)} [7]**  
T-ON and T-OFF can be same or different. The relay (R) keeps on changing its status till power is removed.

**B**



**Signal OFF/ON [8]**  
When switch B1 is closed or opened for preset time T, the relay changes its state after time duration T.
- 2**

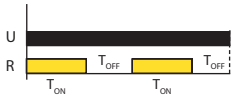

**Cyclic ON/OFF {On Start, (Sym, Asym)} [2]**  
This function is quite similar to the function '1' but initially the relay(R) is ON for period T-ON after the power is applied.

**C**

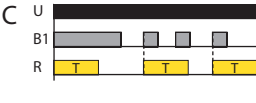

**Leading edge impulse1 [4]**  
A permanent supply is needed. When B1 is closed, output relay energizes until timing irrespective of any further action of B1.
- 3**



**Impulse ON energizing [3]**  
After power ON, R energizes and timing starts. R de-energizes after timing is over.

**D**

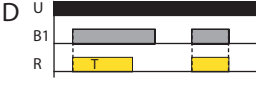

**Leading edge impulse2 [7]**  
Permanent supply is required. when switch B1 is closed, and remains closed output relay energizes until timing is over. If B1 is opened during timing, R resets.
- 4**

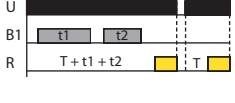

**Accumulative delay ON signal [4]**  
Time commences as supply is present and switch B1 is open. Closing switch B1 pauses timing. Timing resumes when switch B1 is opened again. R energizes at the end of timing.

**E**



**Trailing edge impulse1 [E]**  
Permanent supply required. when B1 is opened, R energizes and de-energizes when timing is over. If B1 is closed during timing R resets.
- 5**

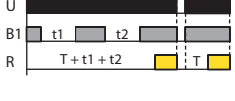

**Accumulative delay ON inverted signal [5]**  
Time commences as supply is present and switch B1 is closed. Opening switch B1 pauses timing. Timing resumes when switch B1 is closed again. R energizes at end of timing.

**F**



**Trailing edge impulse2 [F]**  
Permanent supply is required. When switch B1 is opened, R energizes and will de-energize when timing is over. If B1 is pulsed during timing period it will have no effect on R.
- 6**

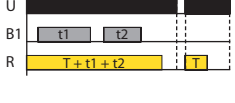

**Accumulative impulse ON signal [6]**  
When supply is ON, R energizes. When switch B1 is closed timing is suspended and remains suspended till switch B1 is opened again. Interrupting supply resets timer.

**G**

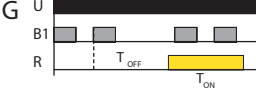

**Delayed impulse [6]**  
When switch B1 is closed, T<sub>OFF</sub> starts. Relay energizes at the end of T<sub>OFF</sub> period. Then, T<sub>OFF</sub> starts irrespective of signal level and relay de-energizes at the end of T<sub>ON</sub> period.
- 7**



**Signal ON delay [7]**  
Permanent supply required. Timing starts when switch B1 is closed. R energizes at end of timing period and de-energizes when B1 is opened.
- 8**

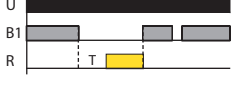

**Inverted signal ON delay [8]**  
Timing will commence when supply is present and switch B1 is open. R energizes after timing. If B1 is closed during timing period, timing resets to the beginning of cycle.
- 9**

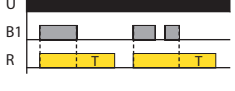

**Signal OFF delay [9]**  
Permanent supply is required. R energizes when switch B1 is closed. Timing commences after S is opened and then the relay de-energizes.



EAN code  
 PDR-2A/230V: 8594030333037  
 PDR-2A/UNI: 8594030333044  
 PDR-2B/230V: 8594030333051  
 PDR-2B/UNI: 8594030333068

Technical parameters	PDR-2/A	PDR-2/B
Function:	16	10
Supply terminals:	A1 - A2	
Voltage range:	AC/DC 12 - 240 V (AC 50-60 Hz)	
Burden (max.):	AC 0.5 - 2.5 VA/DC 0.4 - 2.5 W	
Voltage range:	AC 230 V (50-60 Hz)	
Consumption (apparent/loss):	AC max. 16 VA/2.5 W	
Max. dissipated power (Un + terminals):	5.5 W	
Supply voltage tolerance:	-15 %; +10 %	
Time ranges:	0.01 s - 100 h	
Repeat accuracy:	0.2 % - set value stability	
Temperature coefficient:	0.01 %/°C, at = 20 °C (0.01 %/°F, at = 68 °F)	
<b>Output</b>		
Number of contacts:	2x changeover/SPDT (AgNi/Silver Alloy)	
Current rating:	16 A/AC1; 1 HP 240 Vac, 1/2 HP 120 Vac; PD. B300	
Breaking capacity:	4000 VA/AC1, 384 W/DC	
Inrush current:	30 A/< 3 s	
Switching voltage:	250 V AC/24 V DC	
Output indication:	red LED	
Mechanical life:	30.000.000 ops.	
Electrical strength (AC1):	60.000 ops.	
<b>Control</b>		
Control input Burden:	AC 0.01 - 0.25 VA (UNI), AC 0.25 VA (AC 230 V)	
Glow lamps:	No	
Control. impulse length:	min. 1 ms/max. unlimited	
Reset time:	max. 200 ms	
Display - colour:	red	
Number and height of digits:	4 positions with separating colon, height 10 mm (0.39")	
Luminance:	2200 - 3800 ucd	
Light wavelength:	635 nm	
Brightness setting:	range 20 - 100 % in 10 steps adjustable	
Memory - memory locations:	30 (PDR-2/A)/20 (PDR-2/B) for times ranges + service function	
Data stored for:	min. 10 years	
<b>Other information</b>		
Operating temperature:	-20 .. +55 °C (-4 .. 131 °F)	
Storage temperature:	-30 .. +70 °C (-22 .. 158 °F)	
Dielectric strength:	4 kV (supply - output)	
Operating position:	any	
Mounting:	DIN rail EN 60715	
Protection degree:	IP40 from front panel/IP20 terminals	
Overvoltage category:	III.	
Pollution degree:	2	
Max. cable size (mm <sup>2</sup> ):	solid wire max. 1x 2.5 or 2x 1.5/ with sleeve max. 1x 1.5 (AWG 12)	
Dimensions:	90 x 52 x 65 mm (3.5" x 2" x 2.6")	
Weight:	142 g (5 oz.) (230), 140 g (4.9 oz.) (UNI)	
Standards:	EN 61812-1	

- Multifunction programmable digital relay with 4 digit red LED display.
- Control and setting are done by 3 buttons, user-friendly menu, absolute accuracy in timer setting, time countdown on a display, galvanically separated START and STOP control inputs with UNI supply.
- Thanks to its complexity, it is possible to program also more demanding time functions by using 2 independent times.
- 2 independent times, with combination of 2 inputs and 2 outputs.
- PDR-2/A: 16 functions, choice of functions of the other relay, 30 memory places for most frequently used times.
- PDR-2/B: 10 functions, 1 output of 10 functions can be assigned to each relay = 2 relays in one device.

## Description

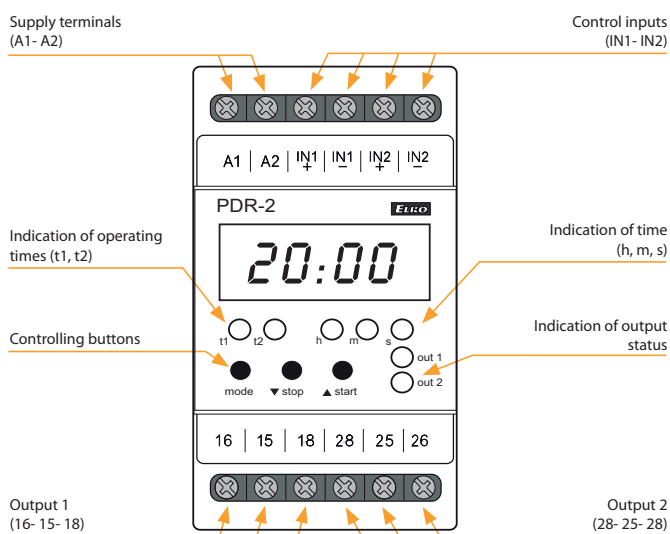

## Symbol

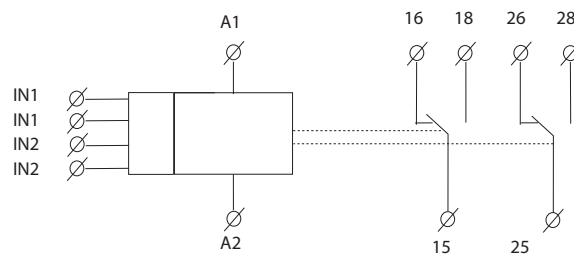

## Time data

Time range:	0.01 s - 99 h 59 min 59 sec 99 ss
Minimal time step:	0.01 s
Time deviation:	0.01 % of set value
Setting error:	0 %
Setting, reset accuracy:	100 %
Digital places:	selected via program



Connection

PDR-2/A

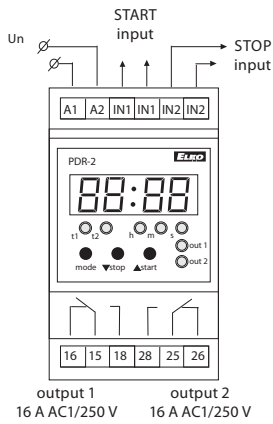

PDR-2/B

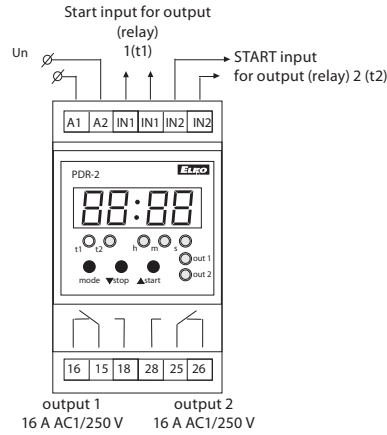

Function

Functions for PDR-2/A and PDR-2/B

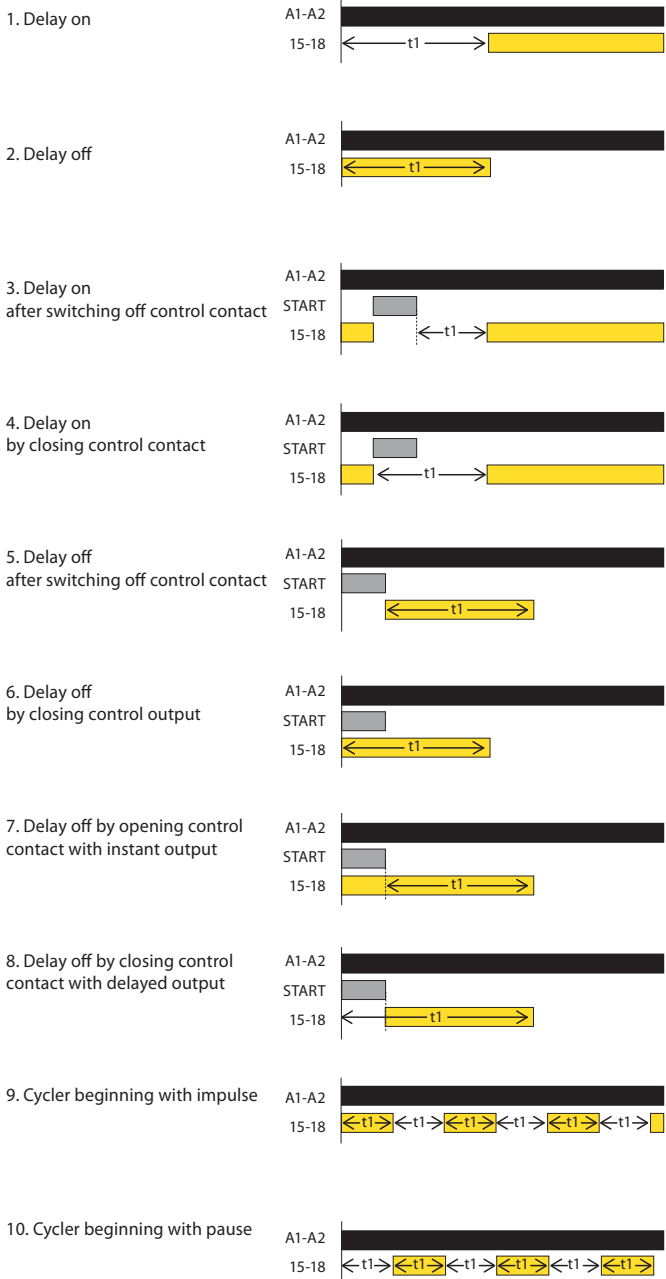

Functions for PDR-2/A

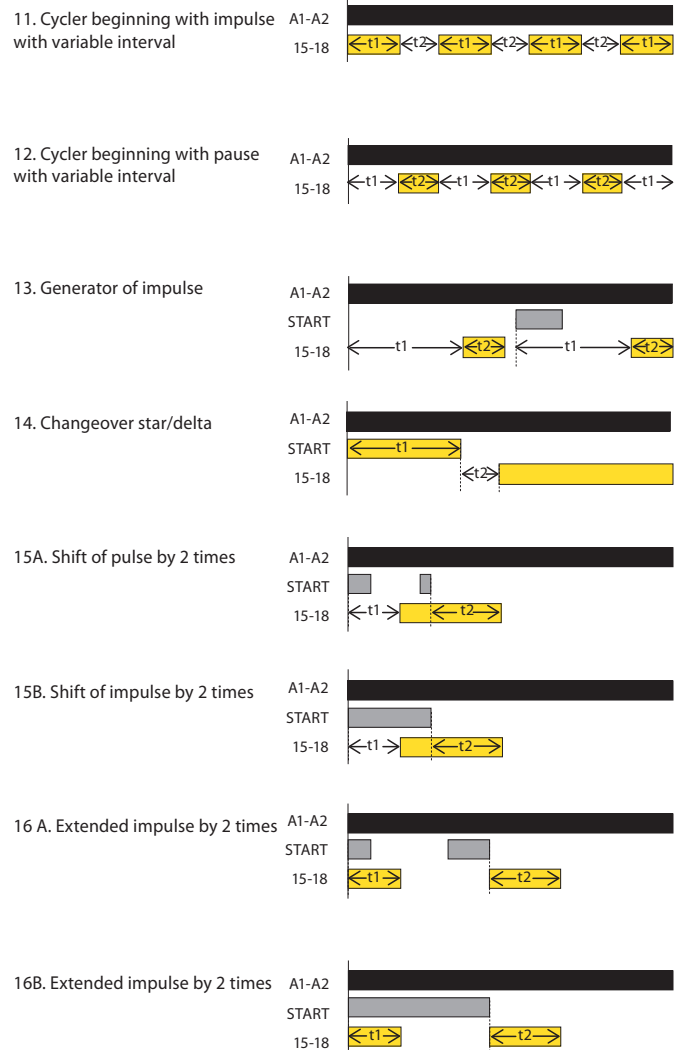

Recommendation:  
PDR-2/B is replacing 2 simple time relays = 2 in 1.



EAN code  
 SMR-K/230V: 8595188145176  
 SMR-T/230V: 8595188129107  
 SMR-H/230V: 8595188129114  
 SMR-B/230V: 8595188135566

Technical parameters	SMR-K	SMR-T	SMR-H	SMR-B
Number of functions:	9		10	
Connection:	3-wire, without neutral		4-wire, with neutral	
Voltage range:	AC 230 V (50-60 Hz)			
Power input (no operation/make):	max. 0.8/3 VA		max. 1/1 VA	
Supply voltage tolerance:	-15 %; +10 %			
Time ranges:	0.1 s - 10 days			
Time setting:	via rotatory switch			
Time deviation:	10 % - mechanical setting			
Repeat accuracy:	2 % - set value stability			
Temperature coefficient:	0.1 %/°C, at = 20 °C (0.1 %/°F, at = 68 °F)			
<b>Output</b>				
Number of contacts:	1 x triac		1x NO-SPST (AgSnO <sub>2</sub> )	
Resistive load:	10 - 160 VA		0 - 200 VA	
Inductive load:	4 W		4 W	
Mechanical life:	30.000.000 ops.			
Electrical life (AC1):	100.000 ops.			
<b>Control</b>				
Control voltage:	AC 230 V		AC 230 V, UNI 5-250V AC/DC	
Control current:	25µA		3 mA	
Impulse length:	min. 50 ms/max. unlimited			
Glow tubes connctions:	x		Yes	
Max. amount of glow lamps connected to controlling input:	x		230 V - max. amount 50 pcs (measured with glow lamp input: 0.68 mA/230 V AC)	
<b>Other information</b>				
Operating temperature:	0 .. +50 °C (+32 .. +122 °F)			
Operating position:	any			
Mounting:	free at connecting wires			
Protection degree:	IP 30 in standard conditions**			
Overvoltage category:	III.			
Pollution degree:	2			
Fuse:	F 1 A/250 V		x	
Connection wires (cross-section/length):	3x CY, 0.75 mm <sup>2</sup> (AWG 18) 90 mm (3.5")		4x sol. wir., 0.75 mm <sup>2</sup> (AWG 18) 90 mm (3.5")	
Glow-lamps in control button:	x		max. 10	
Dimensions:	49 x 49 x 13 mm (1.9" x 1.9" x 0.5")		49 x 49 x 21 mm (1.9" x 1.9" x 0.8")	
Weight:	27 g(0.95 oz.)		28 g(0.98 oz.)	
Standards:	EN 61812-1			

\* 1 HP|240Vac, 1/2 HP|120Vac; PD. B300

\*\* for more information see page 75

- Multifunction relay designed for installation into a wiring box or under wall-switch in an existing electrical installation.
- Advantageous and fast solution for exchanging standard wall-switch for a switch controlled by time or for an impulse relay controlled by a button.
- **SMR-K**
  - 3-wire connection, works without the connection of a neutral conductor
  - power output: 10-160 VA
  - for flawless function of the product is necessary the presence of a load R, L or C between input S and neutral wire.
- **SMR-T**
  - 3-wire connection, works without the connection of a neutral conductor
  - power output: 10 - 160 VA
  - between input S and neutral wire is possible connect any load R, L, or C - that is not necessary (unlike SMR-K).
- **SMR-H**
  - 4-wire connection
  - power output: 0 - 200 VA.
- **SMR-B**
  - 4-wire connection
  - output contact 1x 16 A/4000 VA, 250 V AC1
  - enables switching of fluorescent lights and also energy saving lights
  - independent galvanically separated input AC/DC 5 - 250 V, for example for control from a security system.

## Description

### SMR-H

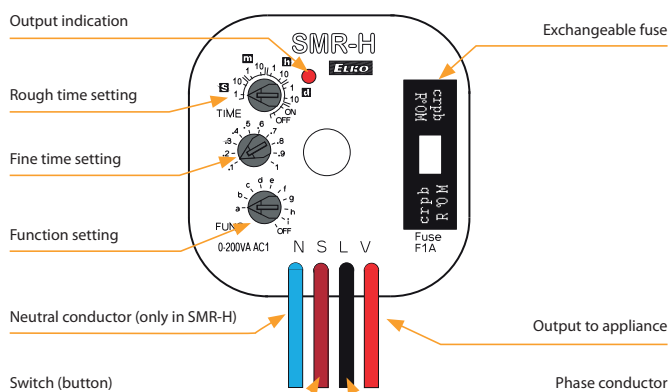

### SMR-B

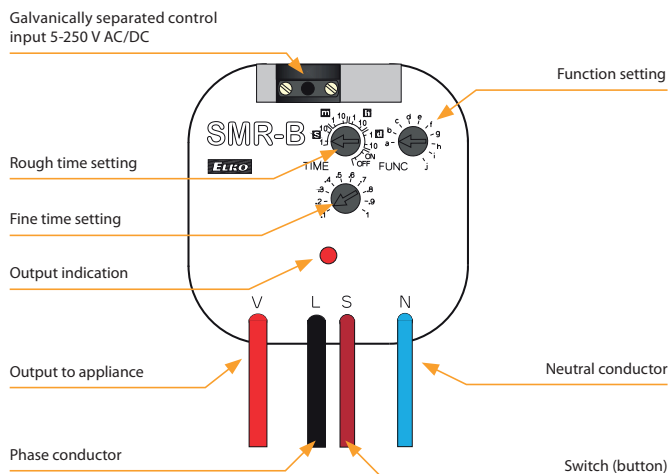

Function

**Function a - delay off on entering edge**  
output times when it is switched. Each following pressing (max. 5x) increases time. Long pressing swithes output off



**Function b - delay off on downward edge**  
output times after button is switched off, switches immediately



**Function c - delayed return to the falling edge**  
When the button is turned off, the output closes and timed. Further presses of the button / activation of input S during the already running timing are not respected



**Function d - cycler - flasher impulsem**  
output cycles in regular interval, cycler starts with an impulse



**Function e - puls shift**  
delay on after the switch is switched on and delay on after it is switched off



**Function f - delay on**  
delay on after switch is switched on until it is switched off



**Function g - impulse relay**  
switches on by a press, another pressing switches the output off. The length of pressing doesn't matter, it is possible to set reaction delay by a potentiometer and thus eliminate rebound of a button

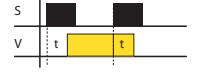

**Function h - impulse relay with delay**  
one press switches on, another one switches the output off in case it is done before the end of timing

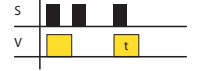

**Function i - cycler starting with pause**  
output cycles in regular intervals, cycler starts with a pause



**Function j\* - cycler starting with gap**  
delay ON until switched off until it is de-energized or a switch is pressed again.  
Note.: \* - Function j is valid only for SMR-B



Connection SMR-K, SMR-T, SMR-H, SMR-B

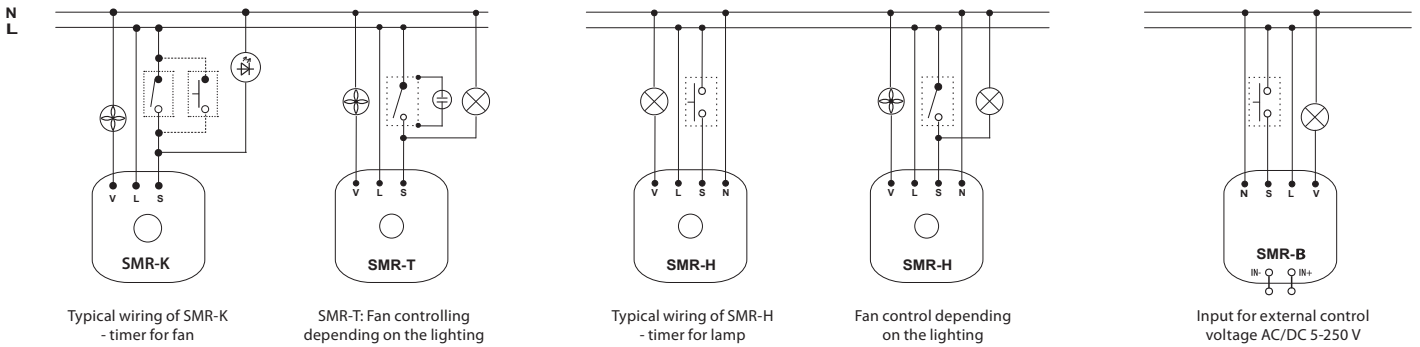

Note: SMR-K, SMR-T, SMR-H are not intended for switching capacity load (energy saving bulbs and LED lights with capacity power etc.), these products are only intended for switching resistive and inductive loads (incandescent bulbs, fans, etc.). SMR-B with relay output is intended to other types of load. Using this output it is possible to switch the load of R, L or C-values listed in the load table. Between inputs S and neutral wire is possible to connect any load of R, L or C, however this is not (unlike the SMR-K) condition.

Example of connection SMR-T

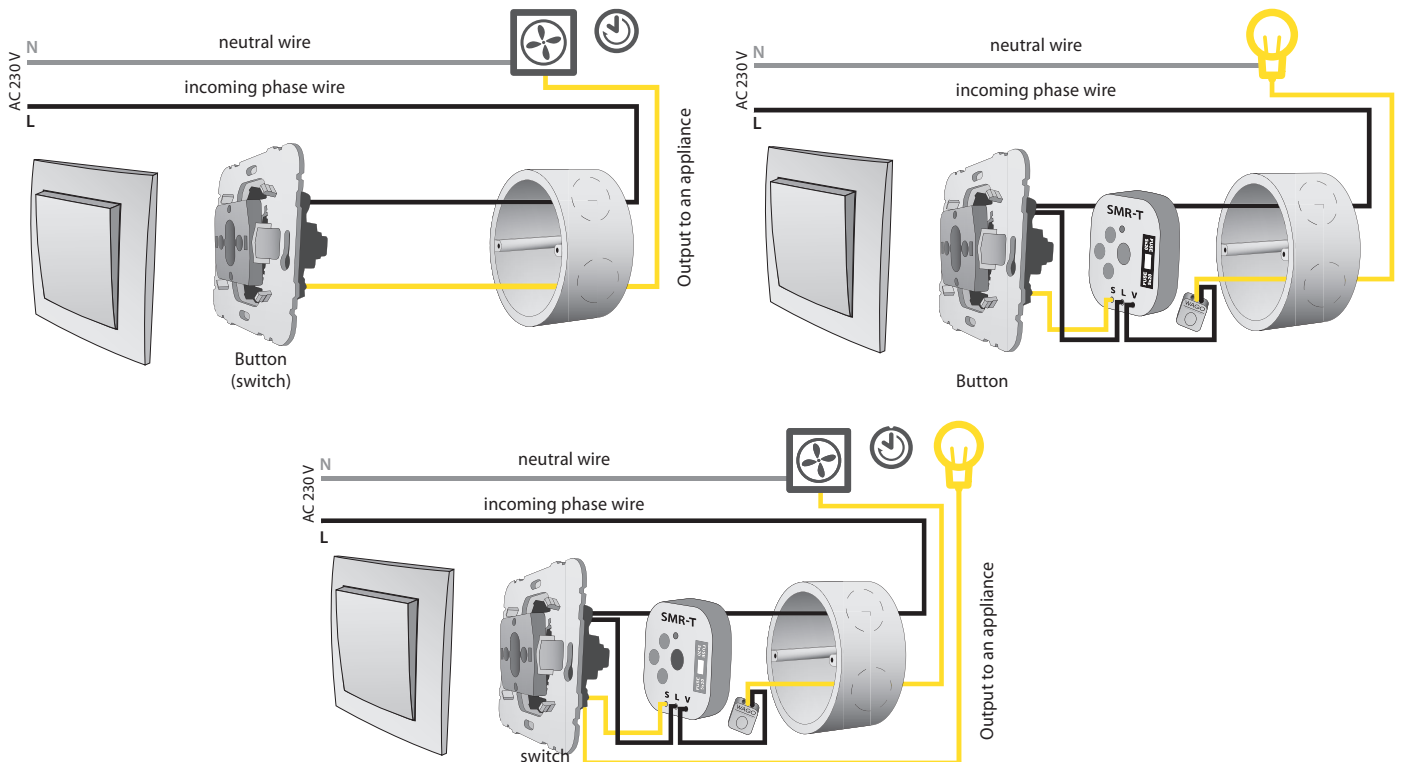



EAN code  
CRM-46: 8595188174916

Technical parameters		CRM-46
Number of functions:		6
Supply terminals:		A1 - A2
Supply voltage:		AC 230 V (50-60 Hz)
Consumption max.:		3 VA/1.6 W
Max. dissipated power (Un + terminals):		4 W
Supply voltage tolerance:		-15 %; +10 %
Supply indication:		green LED
Time ranges:		0.5 - 10 min
Time setting:		potentiometer
Time deviation:		5 % - mechanical setting
Repeat accuracy:		5 % - set value stability
Temperature coefficient:		0.01 %/°C, at = 20 °C (0.01 %/°F, at = 68 °F)
Output		
Number of contacts:		1x NO - SPST (AgSnO <sub>2</sub> ), switches potential A1
Current rating:		16 A/AC1; 1 HP 240 Vac, 1/2 HP 120 Vac; PD. B300
Breaking capacity:		4000 VA/AC1, 384 W/DC
Inrush current:		30 A/< 3 s
Switching voltage:		250 V AC/24 V DC
Output indication:		red LED
Mechanical life:		10.000.000 ops.
Electrical life (AC1):*		100.000 ops.
Control		
Control voltage:		AC 230 V
Power the control input max.:		4.5 VA/0.3 W
Glow tubes connctions:		Yes
Max. Current of connected glow lamps:		100 mA
Control. terminals:		A1-S or A2-S
Impulse length:		min. 40 ms/max. unlimited
Reset time:		max. 320 ms
Other information		
Operating temperature:		-20 .. +55 °C (-4 .. 131 °F)
Storage temperature:		-30 .. +70 °C (-22 .. 158 °F)
Operating position:		any
Mounting:		DIN rail EN 60715
Protection degree:		IP40 from front panel/IP10 terminals
Overvoltage cathegory:		III.
Pollution degree:		2
Max. cable size (mm <sup>2</sup> ):		solid wire max. 2x 2.5 or 1x 4 / with sleeve max. 1x 2.5 or 2x 1.5, (AWG 12)
Dimensions:		90 x 17.6 x 64 mm (3.5" x 0.7" x 2.5")
Weight:		56 g (2 oz.)
Standards:		EN 61812-1

\* For higher loads and frequent switching, it is recommended to strengthen the relay contact with a power contactor, e.g. the VSxxx contactor.

- Staircase switch enables delayed switching off of lighting on stairs, corridors, entrances, common areas or for delayed running of fans in the toilet or bathroom.
- The intelligent staircase switch offers similar application possibilities as the CRM-4, while it is possible to extend the delay for functions a, b repeatedly by briefly pressing the control button (s). Each short press multiplies the time set by the potentiometer, i.e. setting the potentiometer to 2 minutes with three presses extends the delay up to 6 minutes. The maximum value of such an extended delay will always be 30 minutes, regardless of the number of presses.
- Long press (>2 s) can switch off the output prematurely and end the on-going delay.
- Control input with the possibility of loading up to 100 mA load (glim lamp, LED in the button, etc.).
- Function (selectable by potentiometer on the front panel)
  - a – STAIRCASE SWITCH, programmable with signalization
  - b – STAIRCASE SWITCH, programmable without signalization
  - c – MEMORY LATCH (press to switch on, press to switch off)
  - d – MEMORY LATCH with delay
- ON (permanently closed) - e.g. during cleaning, moving
- OFF (permanently open) - e.g. when replacing luminaires.
- Adjustable time range 0.5 to 10 minutes.
- Handles surge currents up to 80 A.
- 3-wire or 4-wire connection (input S can be controlled by potential A1 or A2).

### Description

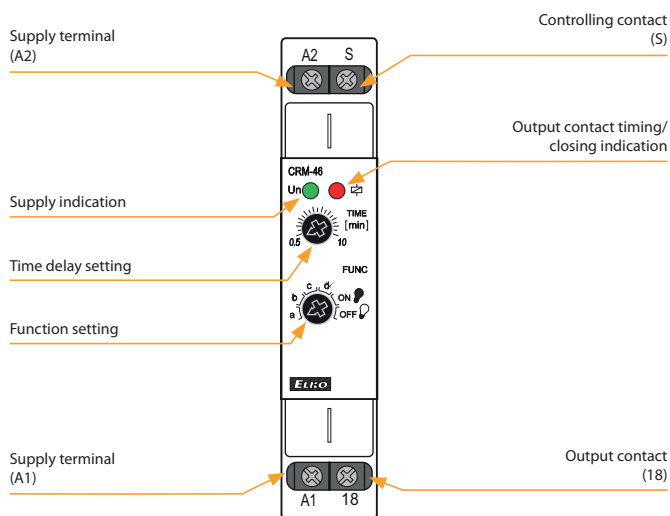

### Circuit connection

3-wire connection

4-wire connection

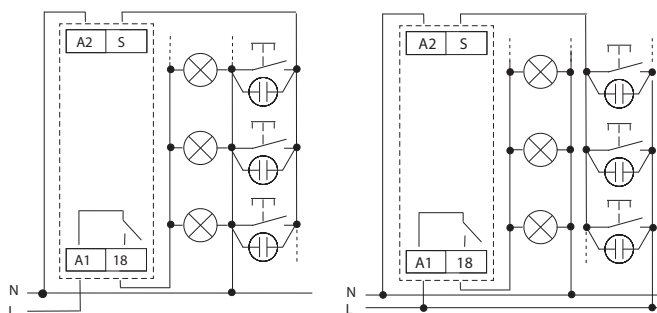

Function

When switching between functions, the red LED flashes.

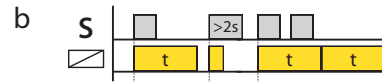
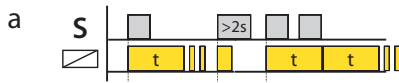

**STAIRCASE SWITCH, programmable with signalization**

The device times the set time, 30 and 40s before the end of the time by double flashing of the luminaire announces the impending switch-off. You can increase the time interval by briefly pressing the button repeatedly. Suitable for resistive loads (e.g. bulbs).

**STAIRCASE SWITCH, programmable without signalization**

The device will time the set time without flashing at the end of the interval. You can increase the time interval by briefly pressing the button repeatedly. The function is suitable for loads that can withstand frequent switching on and off (eg energy saving lamps, LED bulbs).

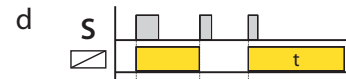
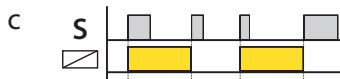

**MEMORY LATCH (press to switch on, press to switch off)**

By pressing the button the output relay closes and by pressing again the relay opens. This function is primarily intended for locations where long-term lighting (without timing) is desirable and the unit is controlled from multiple locations (e.g. in office buildings).

**MEMORY LATCH with delay**

Pressing the button switches the output on/off. If the output is not turned off during the set time "t", it turns off automatically after the timer. This function is suitable for places where lighting is often forgotten (e.g. toilets, corridors, cellars).





EAN code  
CRM-4: 8595188170772

Technical parameters		CRM-4
Number of functions:	3	
Supply terminals:	A1 - A2	
Supply voltage:	AC 230 V (50-60 Hz)	
Consumption max.:	3 VA/1.6 W	
Max. dissipated power (Un + terminals):	4 W	
Supply voltage tolerance:	-15 %; +10 %	
Supply indication:	green LED	
Time ranges:	0.5 - 10 min	
Time setting:	potentiometer	
Time deviation:	5 % - mechanical setting	
Repeat accuracy:	5 % - set value stability	
Temperature coefficient:	0.01 %/°C, at = 20 °C (0.01 %/°F, at = 68 °F)	
Output		
Changeover contacts:	1x changeover (AgSnO <sub>2</sub> )	
Rated current:	16 A/AC1; 1 HP 240 Vac, 1/2 HP 120 Vac; PD. B300	
Switching capacity:	4000 VA/AC1, 384 W/DC	
Inrush current:	30 A/<3 s	
Switching voltage:	250 V AC/24 V DC	
Output indication:	red LED	
Mechanical life:	10.000.000 ops.	
Electrical life (AC1):	100.000 ops.	
Control		
Control voltage:	AC 230 V	
Power on input max.:	4.5 VA/0.3 W	
Control. terminals:	A1-S or A2-S	
Glow-tubes:	yes	
Max. Current of connected glow lamps:	100 mA	
Impulse length:	min. 40 ms/max. unlimited	
Reset time:	max. 320 ms	
Other information		
Operating temperature:	-20 .. +55 °C (-4 .. 131 °F)	
Storage temperature:	-30 .. +70 °C (-22 .. 158 °F)	
Dielectric strength:	4 kV (supply - output)	
Operating position:	any	
Mounting:	DIN rail EN 60715	
Protection degree:	IP40 from front panel/IP20 terminals	
Overvoltage category:	III.	
Pollution degree:	2	
Max. cable size (mm <sup>2</sup> ):	solid wire max. 1x 2.5 or 2x 1.5/ with sleeve max. 1x 2.5 (AWG 12)	
Dimensions:	90 x 17.6 x 64 mm (3.5" x 0.7" x 2.5")	
Weight:	56 g (2 oz.)	
Standards:	EN 61812-1	

- Simple staircase switch used to control lighting in corridors, halls, staircases, common areas.
- Can also be used for delayed fan run-out e.g. in bathrooms, toilets,...
- 3 functions:
  - ON (permanently closed) - e.g. when cleaning, moving
  - AUTO - STAIRCASE SWITCH without signalization
  - OFF (permanently open) - e.g. when replacing lights.
- Adjustable time range 0.5 to 10 minutes.
- Timing can be terminated by long pressing the control button (>2s).
- Possibility to connect control buttons with glow lamps (max. 100mA).
- Handles surge currents up to 80 A.
- 3-wire or 4-wire connection (input S can be controlled by potential A1 or A2).

## Description

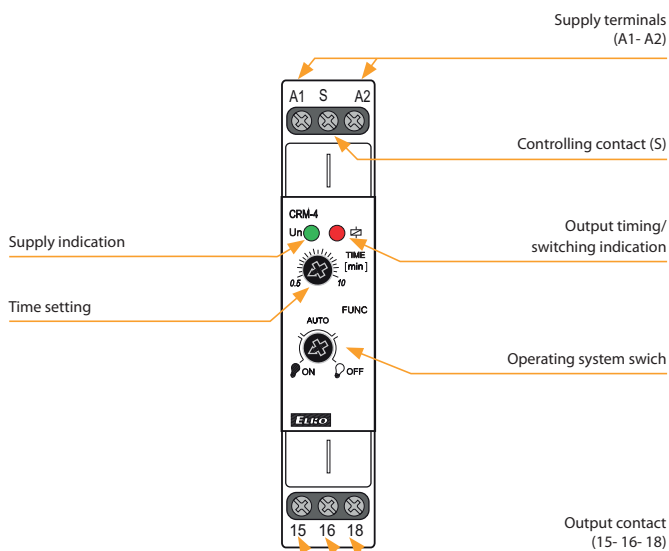

## Circuit connection

### 3-wire connection

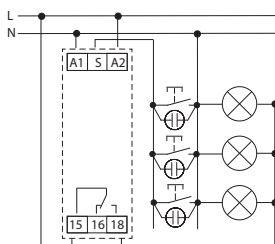

### 4-wire connection

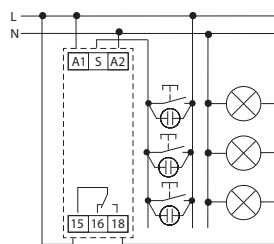

## Function

When switching between functions, the red LED flashes.

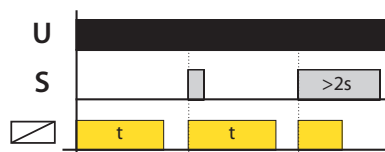

### AUTO - STAIRCASE SWITCH without signalization

By briefly pressing the control button, the device times the set time. You cannot extend the time interval by briefly pressing the button repeatedly. Function suitable for resistive loads (e.g. bulbs) and loads that do not tolerate frequent switching on and off (e.g. energy saving lamps).

### Notice:

- After the supply voltage has been connected, the device always performs 1 time cycle.
- The control input reacts to the potential of terminals A1 and A2.

Digital



SHT-1

Time switch with daily, weekly and yearly prog., 1-channel, out-put 16 A changeover SPDT. page 47



SHT-1/2

As SHT-1 but 2-channel. page 47

Analog



ATS-1DR

Time switch with daily program, power backup 100h, 1x 16 A switching. page 48

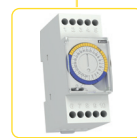

ATS-2D

Time switch with daily program, 1x 16 A changeover. page 49



ATS-2DR

Time switch with daily program, power backup 150 hrs, 1x 16 A changeover. page 49



ATS-2WR

Time switch with weekly program, power backup 150 h, 1x 16 A changeover. page 49

Setup and control via Wi-Fi



SHT-13

Multifunction digital time switch with built-in web server, control and setting via Wi-Fi, all time programs in one device, 1-channel: 1x 16 A changeover/SPDT. page 46



SHT-13/2

As SHT-13 but 2-channel: 2x 16 A changeover/SPDT. page 46

Accessories for SHT-13



**PLUG-IN backup battery module**  
Suitable for backup battery type CR2032 (3V)  
EAN code: 209930603123

Type	Design	Supply voltage	Output contact				Program				Options				Description	Page
			1 channel, 1x 16 A changeover Ag5nO2	2 channel, 2x 16 A changeover Ag5nO2	1 channel, 1x 16 A switching	1 channel, 1x 16 A changeover	daily	weekly	yearly	astro	auto/winter/summer time transition	cyclic/pulse output	replaceable battery	connection via Wi-Fi		
SHT-13	2M	AC/DC 24 - 240 V	●	x	x	x	●	●	●	●	■	●	●	●	Built-in web server for setup and control via Wi-Fi. All programs in one device. Our most advanced and newest type.	46
SHT-13/2	2M	AC/DC 24 - 240 V	x	●	x	x	●	●	●	●	■	●	●	●		
SHT-1	2M	AC/DC 12 - 240 V, AC 230 V	●	x	x	x	●	●	●	x	●*	●	x	x	Time switch for the needs of controlling the connected device according to the user-set program and time, in addition with pulse/cyclic output mode.	47
SHT-1/2	2M	AC/DC 12 - 240 V, AC 230 V	x	●	x	x	●	●	●	x	●*	●	x	x		
ATS-1DR	1M	AC 230V	x	x	●	x	●	x	x	x	x	x	x	x	Daily program, minimum switching interval 15 min, power backup (up to 100 hours).	48
ATS-2D	2M	AC 230V	x	x	x	●	●	x	x	x	x	x	x	x	Daily program, minimum switching interval 30 min, without power backup.	49
ATS-2DR	2M	AC 230V	x	x	x	●	●	x	x	x	x	x	x	x	Daily program, minimum switching interval 30 minutes, power backup (up to 150 hours).	
ATS-2WR	2M	AC 230V	x	x	x	●	x	●	x	x	x	x	x	x	Weekly program, minimum switching interval 3.5 hours, power backup (up to 150 hours).	

\* default settings (can be changed)

■ configurable with first setup

ALL IN ONE

daily  
weekly  
yearly  
astro

WEB  
SERVER

WI-FI  
2.4 GHz



EAN code  
SHT-13: 8595188189071  
SHT-13/2: 8595188184854

Technical parameters	SHT-13	SHT-13/2
Supply terminals:	A1-A2	
Supply voltage:	AC/DC 24 – 240 V (AC 50-60 Hz)	
Consumption (max.):	Wi-Fi "OFF" 0.5 W/2 VA   "ON" 1 W/3 VA	
Supply voltage tolerance:	-15 %; +10 %	
<b>Output</b>		
Contact type:	1x changeover (AgSnO <sub>2</sub> )	2x changeover (AgSnO <sub>2</sub> )
Rated current:	16 A/AC1; 1 HP 240 Vac, 1/2 HP 120 Vac; PD. B300	
Switched power:	4000 VA/AC1, 384 W/DC1	
Inrush current:	30 A/< 3 s	
Switching voltage:	250 V AC/24 V DC	
Power dissipation (max.):	1.2 W	2.4 W
Mechanical life:	30.000.000 ops.	
Electrical life (AC1):	100.000 ops.	
<b>Time circuit</b>		
Accuracy:	max. ±1 s/day at 23°C (73.4 °F)	
Min. switching interval:	1 s	
Data retention time:	min. 10 years	
Set time backup:	up to 3 years (CR 2032 - 3V)	
<b>Program circuit</b>		
Number of memory locations:	200	
Program type:	daily, weekly, yearly, astro	
Displayed data:	LCD display with white backlight	
Settings via website:	by Wi-Fi (2.4 GHz)	
<b>Other information</b>		
Operating temperature:	-20 .. +55 °C (-4 .. 131 °F)	
Storage temperature:	-30 .. +70 °C (-22 .. 158 °F)	
Dielectric strength:		
supply – output	AC 4 kV	
output 1 – output 2	AC 4 kV	
Operating position:	any	
Mounting:	DIN rail EN 60715	
Protection degree:	IP40 front panel / IP20 terminals	
Oversvoltage category:	III.	
Pollution degree:	2	
Cross-wire section – solid/ stranded with ferrule (mm <sup>2</sup> ):	max. 1x 2.5, 2x 1.5/ max. 1x 2.5 (AWG 14)	
Dimensions:	90 x 35 x 64 mm (3.5" x 1.4" x 2.5")	
Weight:	122 g (4.3 oz)	135 g (4.8 oz)
Standards:	EN 61812-1	

Symbol



- All programs in one device (daily, weekly, yearly and astronomical).
- UNiversal supply voltage in range of AC/DC 24 – 240 V (AC 50-60 Hz).
- Simple setting after the first start-up.
- Replaceable battery for time back-up (replace battery without losing real time clock, after disconnection of supply voltage).
- Built-in web server for setup and control via Wi-Fi connection.
- Time synchronization through NTP server (require internet connection).
- New well-arranged display with white backlight.
- ASTROnomic program: manual entry of coordinates or selecting one of the preset cities.
- One/two channel design (each with an operating hours counter).
- Pulse/cycle output mode.
- Transition of summer/winter time – AUTO or OFF.
- Sealable transparent front panel cover.
- PIN code protection against unauthorized changes.
- Wireless firmware update.

Description

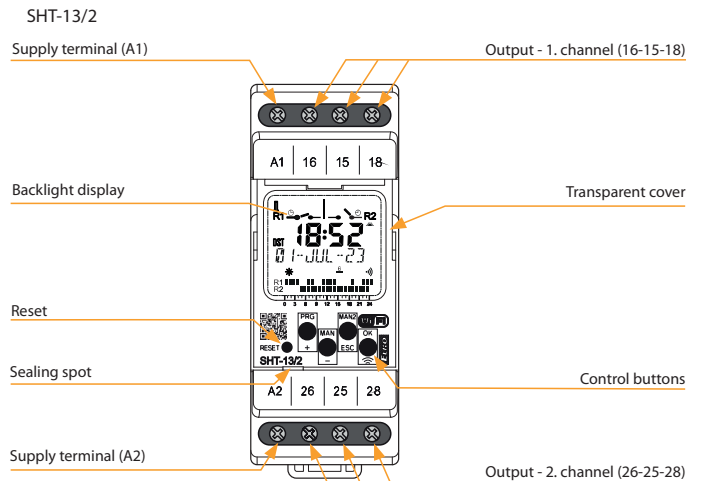

Description of displayed elements

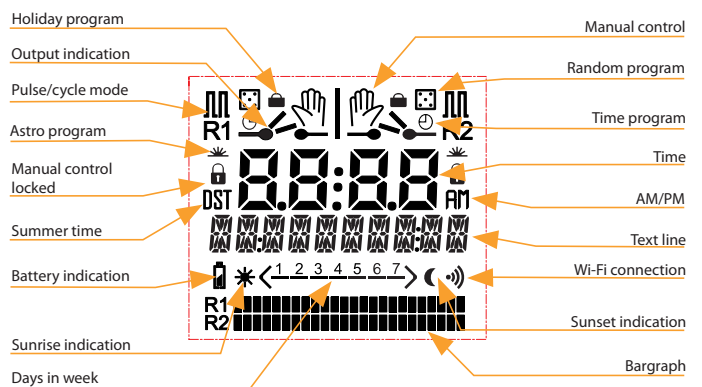

Connection

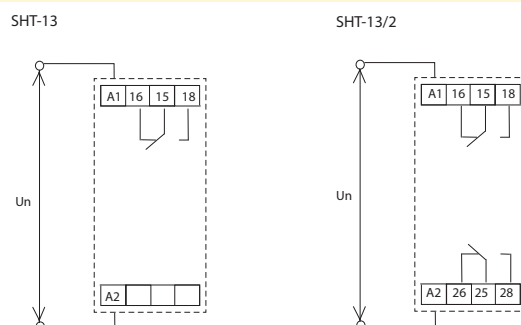



EAN code  
 SHT-1/230V: 8595188130424  
 SHT-1/UNI: 8595188130431  
 SHT-1/2/230V: 8595188130400  
 SHT-1/2/UNI: 8595188130417

Technical parameters	SHT-1	SHT-1/2
Supply terminals:	A1 - A2	
Voltage range:	UNI	AC/DC 12 – 240 V (AC 50-60 Hz)
Burden (max.):		AC 0.5 – 2 VA/DC 0.4 – 2 W
Voltage range:	230	AC 230 V (50-60 Hz)
Burden:		AC max. 14 VA/2 W
Max. dissipated power (Un + terminals):	3.5 W	5 W
Supply voltage tolerance:	-15 %; +10 %	
Back-up supply:	yes	
Summer/winter time:	automatic	
<b>Output</b>		
Contact type:	1x changeover/SPDT (AgSnO <sub>2</sub> ) 2x changeover/SPDT (AgSnO <sub>2</sub> )	
Current rating:	16 A/AC1; 1 HP 240 Vac, 1/2 HP 120 Vac; PD. B300	
Breaking capacity:	4000 VA/AC1, 384 W/DC	
Inrush current:	30 A/< 3 s	
Switching voltage:	250 V AC/24 V DC	
Mechanical life:	30.000.000 ops.	
Electrical life (AC1):	100.000 ops.	
<b>Time circuit</b>		
Power back-up:	up to 3 years	
Accuracy:	max. ±1s/day at 23 °C (73.4 °F)	
Minimum interval:	1 min	
Data stored for:	min. 10 years	
Cyclic output:	1 – 99 s	
Pulse output:	1 – 99 s	
<b>Program circuit</b>		
Number of memory places:	100	
Program:	daily, weekly, monthly, yearly	
Data readout:	LCD display, with back light	
<b>Other information</b>		
Operating temperature:	-20 .. +55 °C (-4 .. 131 °F)	
Storage temperature:	-30 .. +70 °C (-22 .. 158 °F)	
Dielectric strength:	AC 4 kV (supply - output)	
Operating position:	any	
Mounting:	DIN rail EN 60715	
Protection degree:	IP10 clips, IP40 from front panel	
Overvoltage category:	III.	
Polution degree:	2	
Cross-wire section – solid/stranded with ferrule (mm <sup>2</sup> ):	max. 2x 2.5 or 1x 4/ max. 1x 2.5 or 2x 1.5 (AWG 12)	
Dimensions:	90 x 35 x 64 mm (3.5" x 1.4" x 2.5")	
Weight:	(UNI) – 117 g (4.13 oz), (230) – 115 g (4.06 oz)	(UNI) – 132 g (4.7 oz), (230) – 128 g (4.5 oz)
Standards:	EN 61812-1	

- It serves to control various types of appliances depending on real time with the possibility of daily, weekly, monthly and yearly programs.
- Switching: according to program (AUTO)/permanently manually (MAN)/random (E).
- Choice of 1-channel or 2-channel design, each channel is adjustable individually.
- Sealable transparent front panel cover, easy control with 4 buttons.
- Cyclic/pulse output option.
- Real time backup - up to 3 years using built-in battery.
- Automatic summer/winter time transition (can be switched off in settings).
- Supply voltage is divided into two types: AC 230 V or AC/DC 12 – 240 V.

**Description**

SHT-1/2

Supply terminals (A1)

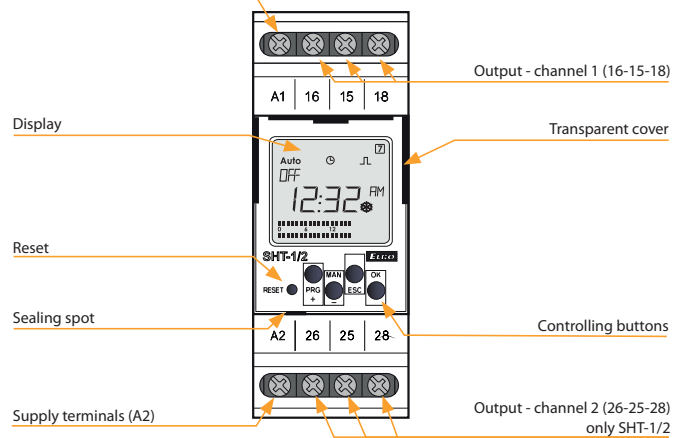

**Description of displayed elements on the screen**

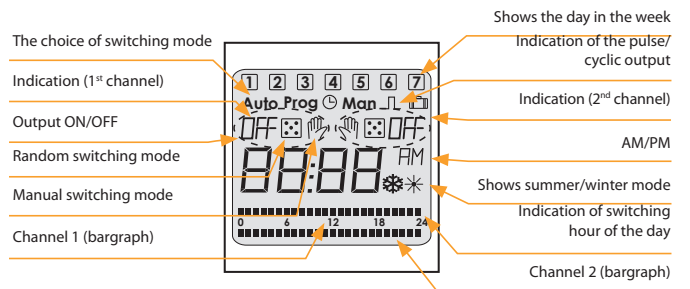

**Connection**

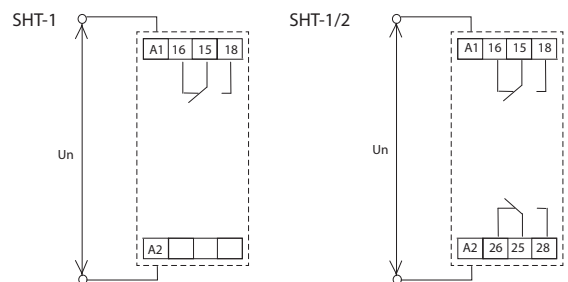

**Symbol**

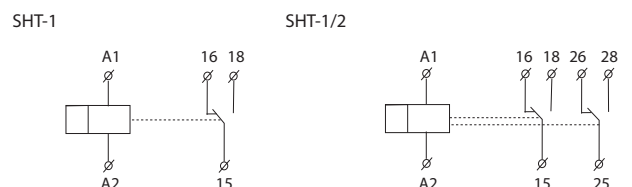

NEW



- The mechanical time switch is a simple and inexpensive alternative to digital time switches for controlling real-time heating, ventilation, cooling, lighting or pump systems.
- Daily program.
- Selection of operating modes using a switch on the panel:
  - 🕒 switches automatically according to the set program
  - I closes permanently
- Power reserve after power failure up to 100 hours, after fully charged.

EAN code  
ATS-1DR: 8595188182171

Technical parameters	ATS-1DR
<b>Supply</b>	
Supply terminals:	L-N
Supply voltage:	AC 230 V (50/60 Hz)
Consumption (max.):	1.5 VA/1 W
Supply voltage tolerance:	-10 %; +10 %
<b>Time circuit</b>	
Program:	daily
Number of switching segments:	96
Min. switching interval:	15 mins
Operating accuracy:	±2s/day at 25 °C
Power reserve:	max. 100 hrs.
<b>Output</b>	
Number of contacts:	1× NO (AgCdO15)
Rated current:	16 A/AC1
Breaking capacity:	4000 VA/AC1
Switching voltage:	250 V AC
Mechanical life:	100.000 ops.
Electrical life (AC1):	30.000 ops.
<b>Other information</b>	
Operating temperature:	-10 .. +50 °C (14 .. 122 °F)
Storage temperature:	-10 .. +50 °C (14 .. 122 °F)
Dielectric strength:	4 kV (supply – output)
Operating position:	any
Mounting:	DIN rail EN 60715
Protection degree:	IP20
Overvoltage category:	III.
Pollution degree:	2
Cross-wire section – solid/ stranded with ferrule (mm <sup>2</sup> ):	max. 1× 4, 2× 2.5/ max. 1× 4 (12 AWG)
Dimensions:	90 × 18 × 66 mm (3,55" × 0,71" × 2,6")
Weight:	70 g (2.5 oz)
Standards:	EN 61812-1, EN 60730

### Description

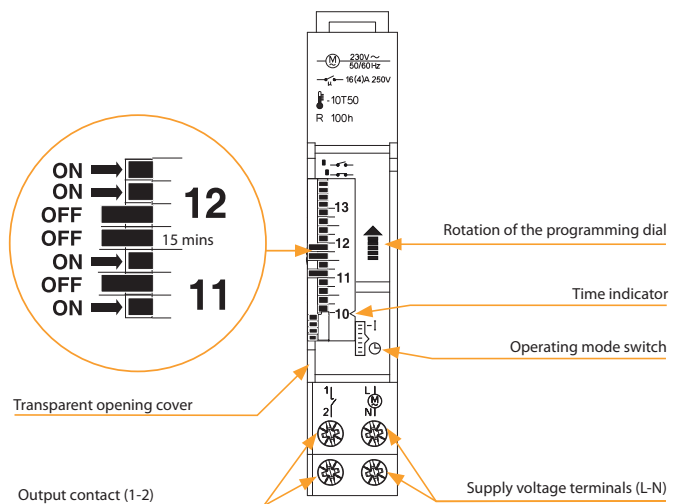

### Circuit connection

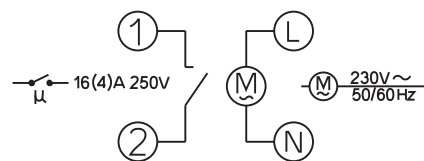



EAN code  
 ATS-2D: 8595188182126  
 ATS-2DR: 8595188182188  
 ATS-2WR: 8595188182140

Technical parameters	ATS-2D	ATS-2DR	ATS-2WR
<b>Supply</b>			
Supply terminals:	4-5	L-N	4-5
Supply voltage:	AC 230 V (50/60 Hz)		
Consumption (max.):	1.6 VA/1 W		
Supply voltage tolerance:	-10%; +10%		
<b>Time circuit</b>			
Program:	daily	daily	weekly
Number of switching segments:	48		
Minimum switching interval:	30 mins	30 mins	3.5 hrs
Operating accuracy:	±2 s/day		
Power reserve:	x	max. 150 hrs	
<b>Output</b>			
Contact type:	1x changeover (AgNi)	1x changeover (AgCdO15)	1x changeover (AgNi)
Rated current:	16 A/AC1		
Breaking capacity:	3500 VA/AC1		
Switching voltage:	250 V AC		
Mechanical life:	2.000.000 ops.	100.000 ops.	2.000.000 ops.
Electrical life (AC1):	100.000 ops.	30.000 ops.	100.000 ops.
<b>Other information</b>			
Operating temperature:	-10 .. +50 °C (14 .. 122 °F)		
Storage temperature:	-10 .. +50 °C (14 .. 122 °F)		
Dielectric strength:	AC 4 kV (supply – output)		
Operating position:	any		
Mounting:	DIN rail EN 60715		
Protection degree:	IP20		
Overvoltage category:	III.		
Pollution degree:	2		
Cross-wire section – solid/stranded with ferrule (mm <sup>2</sup> ):	max. 1x 4, 2x 1.5/ max. 1x 4, 2x 1.5 (AWG 12)		
Dimensions:	91 x 36 x 61 mm (3.6" x 1.4" x 2.4")		
Weight:	120 g (4.25 oz)		
Standards:	EN 61812-1, EN 60730-1		

**Connection**

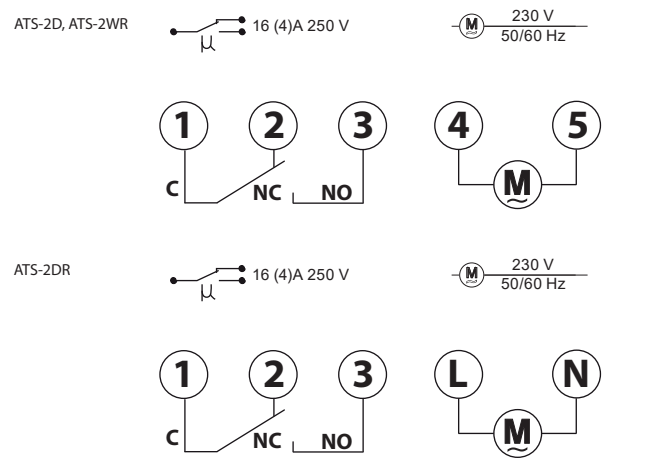

- The mechanical time switch is a simple and inexpensive alternative to digital time switches for controlling heating, ventilation, cooling, lighting systems or pumps depending on real time.
- Power reserve after power off for up to 150 hours after fully charged.
- Sealable transparent front panel cover.
- The ATS-2DR package includes a plastic DIN rail.
- Selection of operating modes using the switch on the panel:
  - ATS-2D, ATS-2WR**
    - ⌚ switches automatically according to the set program
    - I permanently closes
    - O permanently opens
  - ATS-2DR**
    - I permanently closes
    - II switches automatically according to the set program

**Description**

ATS-2D, ATS-2WR

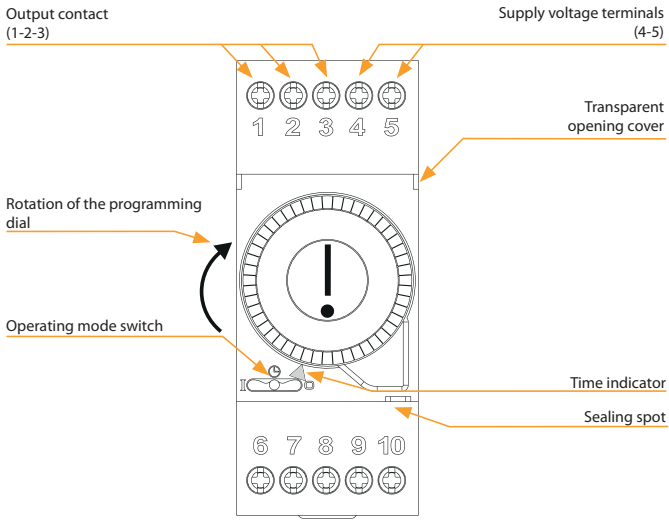

ATS-2DR

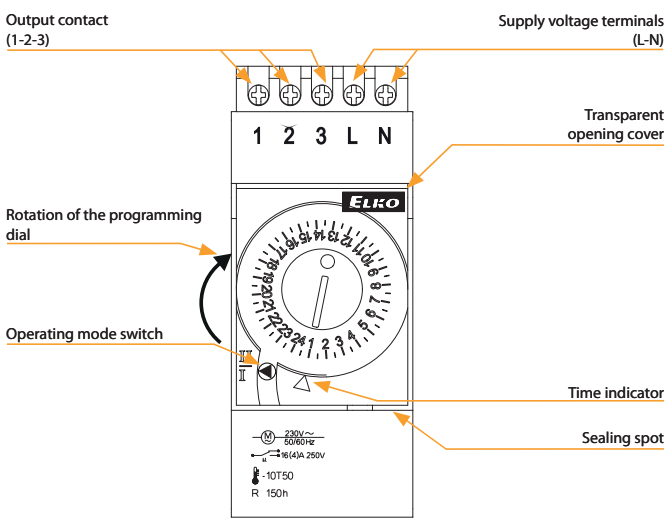



## VS



VS116B/230

Supply voltage:  
AC 230 V  
Output contact:  
1x changeover/SPDT 16 A.  
page 51



VS116K

Supply voltage:  
AC 230 V and AC/DC 24 V  
Output contact:  
1x changeover/SPDT 16 A.  
page 51



VS308K

Supply voltage:  
AC 230 V and AC/DC 24 V  
Output contacts:  
3x changeover/TPDT 8 A.  
page 51



VS316/24

Supply voltage: AC/DC  
24 V Output contacts:  
3x changeover/TPDT  
16 A, possibility to be  
connected into 3-phase  
circuit.  
page 51



VS316/230

Supply voltage:  
AC 230 V  
Output contacts:  
3x changeover/TPDT  
16 A, possibility to be  
connected into 3-phase  
circuit.  
page 51



VS116U

Supply voltage:  
AC/DC 12-240 V  
Output contact:  
1x changeover/SPDT 16 A.  
page 51



VS308U

Supply voltage:  
AC/DC 12-240 V  
Output contacts:  
3x changeover/TPDT 8 A.  
page 51

Type	Design	Supply voltage	Output contact	Other features			Description	Page
				LED signal light	RC unit	Parallel diode		
VS116B/230	BOX	AC 230 V	1x16 A changeover/ SPDT	●	x	x	VS116B/230 MINI, with installation into junction box or ceiling that allows control of lights, shades or awnings drives	51
VS116K	1M-DIN	AC 230, AC/DC 24 V	1x16 A changeover/ SPDT	●	●	●	as a separation relay (4kV), direct switching of appliances up to 4000 VA (e.g. heaters), well visible signalization	
VS116U	1M-DIN	AC/DC 12 – 240 V	1x16 A changeover/ SPDT	●	●	●	as VS116K, but universal supply voltage	
VS308K	1M-DIN	AC 230, AC/DC 24 V	3x 8 A changeover/ TPDT	●	●	●	a "multiplication" of contacts, 3x changeover contact/ 3PDT only in 1-MODULE, well visible signalization	
VS308U	1M-DIN	AC/DC 12 – 240 V	3x 8 A changeover/ TPDT	●	●	●	as VS308K, but universal supply voltage	
VS316/24	1M-DIN	AC/DC 24 V	3x16 A changeover/ TPDT	●	●	●	3x changeover contact in 1-MODULE, possibility of "multiplication" of contacts and in the same time possibility of switching high output, possibility of 3 phase switching	
VS316/230	1M-DIN	AC 230 V	3x16 A changeover/ TPDT	●	●	●	as VS316/24, but AC 230 V	



- Power relay used for switching larger load output, strengthen or „multiplying“ contacts of the existing device.
- Relays VS316/24, VS316/230 enable connection to a 3-phase circuit.
- In the design 1-MODULE , DIN rail mounting, output status indicated by high intensity LED with choice of LED color (red, green, blue or white LED\*).
- VS116B/230 MINI, mounting in installation box or ceilings, enabling switching of lights, motors for blinds or awnings.
- For VS116B/230 status of output indicated by LED on front panel of device.

Technical parameters	VS116B/230	VS116K	VS116U	VS308K	VS308U	VS316/24	VS316/230
Supply terminals:	L - N		A1 - A2				
Voltage range:	AC 230 V (50-60 Hz)	AC 230 V (50-60 Hz)	AC/DC 12-240 V (50-60 Hz)	AC 230 V (50-60 Hz)	AC/DC 12-240 V (50-60 Hz)	AC/DC 24 V (50-60 Hz)	AC 230 V (50-60 Hz)
Burden (max.):	AC 7.5 VA 1 W	AC 7.5 VA 1 W	AC 0.7 - 3 VA/DC 0.5 - 1.7 W	AC 10.3 VA 1.1 W	AC 0.7 - 3 VA/DC 0.5 - 1.7 W	1.6 VA 1.2 W	2.5 VA
Supply terminals:	x	A1 - A3	x	A1 - A3		x	
Voltage range:	x	AC/DC 24 V (AC 50-60 Hz)	x	AC/DC 24 V (AC 50-60 Hz)		x	
Burden:	x	AC 1 VA/DC 1W	x	AC 1 VA/DC 1W		x	
Supply voltage tolerance:	-15%; +10%						
Max. dissipated power (Un + terminals):	4 W			3 W		8 W	6 W
<b>Output</b>							
Number of contacts:	1 x changeover/SPDT (AgSnO <sub>2</sub> )			3 x changeover/TPDT (AgNi/Silver Alloy)		3 x changeover/TPDT (AgSnO <sub>2</sub> )	
Current rating:	16 A/AC1; 1 HP 240Vac, 1/2 HP 120Vac; PD. B300			8 A/AC1; 1/2 HP 240Vac; PD. B300		16A/AC1; 1 HP 240Vac, 1/2 HP 120Vac; PD. B300	
Breaking capacity:	4000VA/AC1, 384W/ DC			2000VA/AC1, 192W/ DC		4000VA/AC1, 384W/DC	
Inrush current:	30 A/<3 s			10 A/<3 s		30 A/<3 s	
Switching voltage:	250V AC/24V DC						
Output indication:	red LED	high intensity LED					
Mechanical life:	30.000.000 ops.						
Electrical life (AC1):	100.000 ops.			60.000 ops.		100.000 ops.	
Time between switching:	min. 2s					20 ms	50 ms
<b>Other information</b>							
Operating temperature:	-20 .. +55 °C (-4 .. 131 °F)						
Storage temperature:	-30 .. +70 °C (-22 .. 158 °F)						
Dielectric strength:	4 kV (supply-output)						
Operating position:	any						
Mounting:	free at connecting wire	DIN rail EN 60715					
Protection degree:	IP30	IP40 from front panel/IP20 terminals					
Overvoltage category:	III.						
Pollution degree:	2						
Max. cable size (mm <sup>2</sup> ):	2x 0.75 mm <sup>2</sup> (AWG 18), 3x 2.5 mm <sup>2</sup> (AWG 10)	max. 1x 2.5 or 2x 1.5 max. 1x 2.5 (AWG 12)					
Dimensions:	49 x 49 x 21 mm (2" x 2" x 0.8")	90 x 17.6 x 64 mm (3.5" x 0.7" x 2.5")					
Weight:	48 g (1.7 oz.)	56 g (2 oz.)	59 g (2.1 oz.)	78 g (2.75 oz.)	80 g (2.8 oz.)	90 g (3.17 oz.)	93 g (3.3 oz.)
Standards:	EN 60669-1, EN 60669-2-1						

Description

VS116K, VS116U

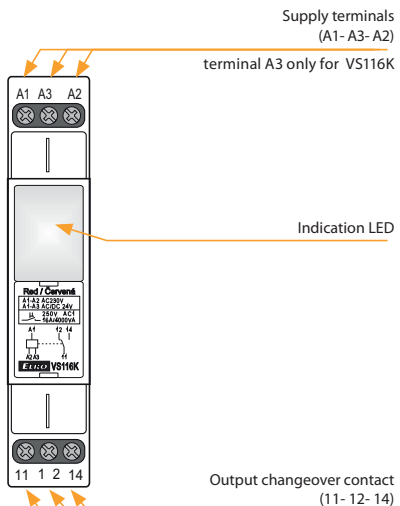

VS308K, VS308U

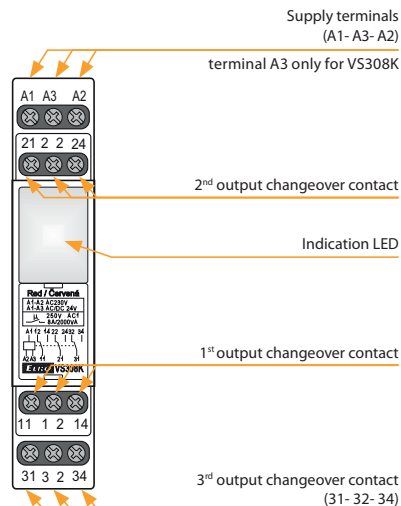

VS316/24, VS316/230

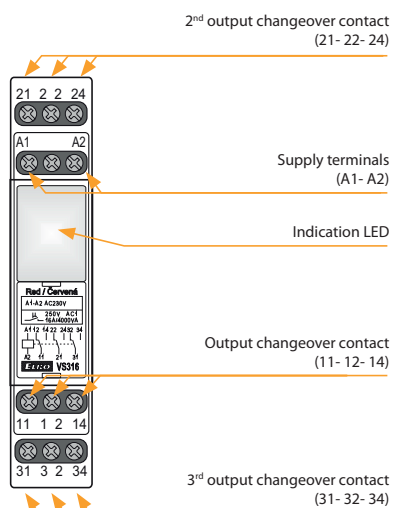

VS116B/230

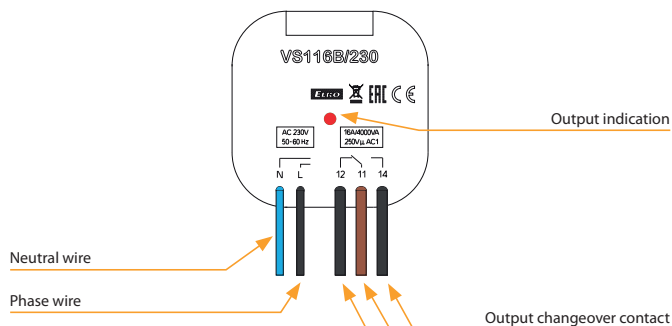

Symbol

VS116B/230

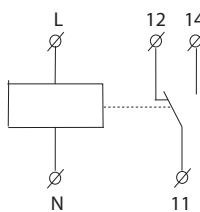

VS116K

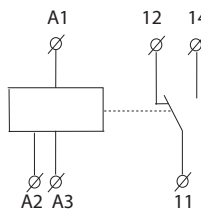

VS116U

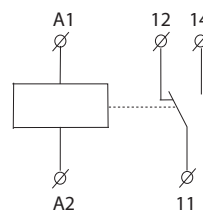

VS308K

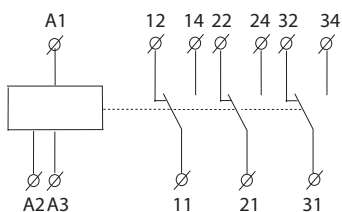



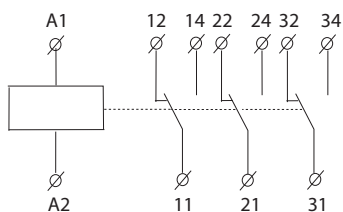

VS308U, VS316/24, VS316/230



EAN codes

VS116B/230	8595188147545				
VS116K/red	8595188122597	VS308K/red	8595188122696	VS316/24 red	8595188135771
VS116K/green	8595188122610	VS308K/green	8595188122719	VS316/24 green	8595188136105
VS116K/white	8595188122573	VS308K/white	8595188122672	VS316/24 white	8595188136099
VS116K/blue	8595188122603	VS308K/blue	8595188122702	VS316/24 blue	8595188136112
VS116U/red	8595188124607	VS308U/red	8595188130103	VS316/230 red	8595188135559
VS116U/green	8595188136433	VS308U/green	8595188136440	VS316/230 green	8595188136075
VS116U/white	8595188138482	VS308U/white	8595188138512	VS316/230 white	8595188136051
VS116U/blue	8595188138475	VS308U/blue	8595188138505	VS316/230 blue	8595188136068

Order code

	<b>VS116K/red:</b> 2295	<b>VS116U/red:</b> 2460	<b>VS308K/red:</b> 2269	<b>VS308U/red:</b> 3010	<b>VS316/24V red:</b> 3577	<b>VS316/230V red:</b> 4471
	<b>VS116K/green:</b> 2261	<b>VS116U/green:</b> 3643	<b>VS308K/green:</b> 2271	<b>VS308U/green:</b> 3644	<b>VS316/24V green:</b> 3610	<b>VS316/230V green:</b> 4472
	<b>VS116K/white:</b> 2257	<b>VS116U/white:</b> 3848	<b>VS308K/white:</b> 2267	<b>VS308U/white:</b> 3851	<b>VS316/24V white:</b> 3609	<b>VS316/230V white:</b> 4470
	<b>VS116K/blue:</b> 2260	<b>VS116U/blue:</b> 3847	<b>VS308K/blue:</b> 2270	<b>VS308U/blue:</b> 3850	<b>VS316/24V blue:</b> 3611	<b>VS316/230V blue:</b> 4474

Notes

Max. time of changeover of contact is 10 ms.

VS316/24 or VS316/230 enables switching of different phases or 3-phase voltage.

\* possibility to choose blue and white color of LED for power relays line VS in case of minimal order quantity 100 pcs.

## Installation contactors VS



VS120

Number of contacts:  
1x20 A. Configuration  
of switching and  
breaking contacts:  
10, 01.  
page 55



VS220

Number of contacts:  
2x20 A. Configuration  
of switching and  
breaking contacts: 20,  
11, 02.  
page 55



VS420

Number of contacts:  
4x20 A. Configuration  
of switching and  
breaking contacts:  
40, 31.  
page 55



VS425

Number of contacts:  
4x25 A. Configuration  
of switching and  
breaking contacts:  
40, 31, 22, 04.  
page 55



VS440

Number of contacts:  
4x40 A. Configuration  
of switching and  
breaking contacts:  
40, 31, 22, 04.  
page 55



VS463

Number of contacts:  
4x63 A. Configuration  
of switching and  
breaking contacts:  
40, 31, 22.  
page 55

## Installation contactors with manual control VSM



VSM220

Number of contacts:  
2x20 A. Configuration  
of switching and  
breaking contacts: 20,  
11, 02.  
page 56



VSM425

Number of contacts:  
4x25 A. Configuration  
of switching and  
breaking contacts:  
40, 31, 22, 04.  
page 56

## Accessories



VSK-11

Auxiliary contacts:  
1x switching,  
1x breaking.  
page 57



VSK-20

Auxiliary contacts:  
2x switching.  
page 57



- For switching electric circuits, especially for resistive loads and 3-phase induction motors
- Number of contacts: VS120 - 1, VS220 - 2, VS325, VS340, VS363 - 3, VS420, VS425, VS440, VS463 - 4
- It is produced in configuration of switching and breaking contacts:  
 VS120: 10, 01 VS220: 20, 11, 02  
 VS420: 40, 31  
 VS325: 30 VS425: 40, 31, 22, 13 04  
 VS340: 30 VS440: 40, 31, 22, 04  
 VS363: 30 VS463: 40, 31, 22
- Protection IP20 - on request we deliver covers that ensure protection IP40 except contactor VS420
- It is possible to connect auxiliary contacts VSK to contactors VS425, VS440, VS463

EAN code see page 59

Technical parameters	VS120	VS220	VS420	VS325/VS425	VS340/VS440	VS363/VS463
Rated insulation voltage (Ui):	230 V	230 V	415 V	440 V	440 V	440 V
Rated thermo-current I <sub>th</sub> (in AC):	20 A	20 A	20 A	25 A	40 A	63 A
Voltage range:	50/60 Hz	50/60 Hz	50/60 Hz	50/60 Hz	50/60 Hz	50/60 Hz
<b>Switched operation</b>						
AC-1 for 400 V, 3 phase:	x	x	13 kW	16 kW	26 kW	40 kW
AC-1 for 230 V:	4 kW, 1 phase	4 kW, 1 phase	7.5 kW, 3 phase	9 kW, 3 phase	16 kW, 3 phase	24 kW, 3 phase
AC-3 for 400 V, 3 phase:	x	x	2.2 kW	4 kW	11 kW	15 kW
AC-3 for 230 V:	1.3 kW only NO, 1 phase	1.3 kW only NO, 1 phase	1.1 kW, 3 phase	2.2 kW, 3 phase	5.5 kW, 3 phase	8.5 kW, 3 phase
AC-7a for 400 V, 3 phase:	x	x	13 kW	16 kW	26 kW	40 kW
AC-7a for 230 V:	4 kW, 1 phase	4 kW, 1 phase	7.5 kW, 3 phase	9 kW, 3 phase	16 kW, 3 phase	24 kW, 3 phase
AC-7b for 400 V, 3 phase:	x	x	2.2 kW	4 kW	11 kW	15 kW
AC-7b for 230 V:	1.3 kW only NO, 1 phase	1.3 kW only NO, 1 phase	1.1 kW, 3 phase	2.2 kW, 3 phase	5.5 kW, 3 phase	8.5 kW, 3 phase
AC-15 for 400 V, 1 phase:	4 A	4 A	4 A	4 A	4 A	4 A
AC-15 for 230 V, 1 phase:	6 A	6 A	6 A	6 A	6 A	6 A
DC1 U <sub>e</sub> = 24/110/220 V:	20/6/0.6 A	20/6/0.6 A	20/2/0.5 A	25/6/0.6 A	40/4/1.2 A	63/4/1.2 A
Loadability of modular contactors see page 58						
The max. number of switching for max. load:	600 switch/hr.	600switch/hr.	600 switch/hr.	600 switch/hr.	600 switch/hr.	600 switch/hr.
<b>Electrical life in 230/400 V</b>						
AC-1- resistive load :	200.000	200.000	200.000	200.000	100.000	100.000
AC-3-power load:	300.000	300.000	300.000	500.000	500.000	150.000
AC-5a - high-intensity discharge lamp:	100.000 by 30 µF	100.000 by 30 µF	300.000 by 36 µF	100.000 by 36 µF	100.000 by 220 µF	100.000 by 330 µF
AC-5b - incandescent lamps:	100.000 by 2 kW	100.000 by 2 kW	100.000 by 2 kW	100.000 by 2 kW	100.000 by 4 kW	100.000 by 5 kW
AC-7a - resistive household devices:	200.000	200.000	200.000	200.000	100.000	100.000
AC-7b - inductive household devices:	300.000	300.000	300.000	300.000	150.000	150.000
Minimal load:	≥ 17 V, ≥ 50 mA	≥ 17 V, ≥ 50 mA	≥ 17 V, ≥ 50 mA	≥ 17 V, ≥ 50 mA	≥ 17 V, ≥ 50 mA	≥ 24 V, ≥ 100 mA
Short circuit protection with the fuse char. aM:	20 A	20 A	20 A	25 A	63 A	80 A
Coordination Type according EN 60 947-4-1:	2	2	2	2	2	2
Dielectric strenght:	4 kV	4 kV	4 kV	4 kV	4 kV	4 kV
<b>Contacts - max. cable size</b>						
Solid conductor:	AWG 7 (10 mm <sup>2</sup> )	AWG 7 (10 mm <sup>2</sup> )	AWG 14 (2.5 mm <sup>2</sup> )	AWG 10 (10 mm <sup>2</sup> )	AWG 10 (25 mm <sup>2</sup> )	AWG 10 (25 mm <sup>2</sup> )
Stranded conductor:	AWG 8 (6 mm <sup>2</sup> )	AWG 8 (6 mm <sup>2</sup> )	AWG 14 (2.5 mm <sup>2</sup> )	AWG 8 (6 mm <sup>2</sup> )	AWG 4 (16 mm <sup>2</sup> )	AWG 4 (16 mm <sup>2</sup> )
Maximal torque:	1.2 Nm (10.62 lbf.in)	1.2 Nm (10.62 lbf.in)	1.2 Nm (10.62 lbf.in)	1.2 Nm (10.62 lbf.in)	3.5 Nm (30.95 lbf.in)	3.5 Nm (30.95 lbf.in)
<b>Coil - max. cable size</b>						
Solid conductor:	AWG 14 (2.5 mm <sup>2</sup> )	AWG 14 (2.5 mm <sup>2</sup> )	AWG 14 (2.5 mm <sup>2</sup> )	AWG 14 (2.5 mm <sup>2</sup> )	AWG 14 (2.5 mm <sup>2</sup> )	AWG 14 (2.5 mm <sup>2</sup> )
Stranded conductor:	AWG 14 (2.5 mm <sup>2</sup> )	AWG 14 (2.5 mm <sup>2</sup> )	AWG 14 (2.5 mm <sup>2</sup> )	AWG 14 (2.5 mm <sup>2</sup> )	AWG 14 (2.5 mm <sup>2</sup> )	AWG 14 (2.5 mm <sup>2</sup> )
Max. torque:	0.6 Nm (5.31 lbf.in)	0.6 Nm (5.31 lbf.in)	0.6 Nm (5.31 lbf.in)	0.6 Nm (5.31 lbf.in)	0.6 Nm (5.31 lbf.in)	0.6 Nm (5.31 lbf.in)
<b>Operating</b>						
Coil control voltage:	AC/DC 24 V, 120 V, 230 V	AC/DC 24 V, 48 V, 120 V, 230 V	AC 12 V, 24 V, 48 V, 120 V, 230 V	AC/DC 24 V, 48 V, 120 V, 230 V	AC/DC 24 V, 120 V, 230 V	AC/DC 24 V, 48 V, 120 V, 230 V
Coil permanent supply +/- 10 %:	2.1 VA/2.1 W	2.1 VA/2.1 W	5 VA/1.5 W	2.6 VA/2.6 W *	5 VA/5 W	5 VA/5 W
Coil gear supply +/- 10 %:	2.1 VA/2.1 W	2.1 VA/2.1 W	30 VA/25 W	2.6 VA/2.6 W *	5 VA/5 W	5 VA/5 W
Mounting side-by-side:	max. 2 contactors**	max. 2 contactors**	max. 2 contactors**	max. 2 contactors**	max. 2 contactors**	max. 2 contactors**
Operational temperature:	-5 .. +55 °C (23 .. 131 °F)					
Storing temperature:	-30 .. +80 °C (-22 .. 176 °F)					
Weight:	120 g (4.2 oz.)	130 g (4.6 oz.)	170 g (6 oz.)	213 g (7.5 oz.)	400 g (14 oz.)	400 g (14 oz.)
Dimensions:	17.5 x 85 x 60 mm (0.7" x 3.35" x 2.4")	17.5 x 85 x 60 mm (0.7" x 3.35" x 2.4")	35 x 62.5 x 57 mm (1.4" x 2.7" x 2.24")	35 x 85 x 60 mm (1.4" x 3.35" x 2.4")	53.3 x 84 x 60 mm (2.1" x 3.31" x 2.4")	53.3 x 84 x 60 mm (2.1" x 3.31" x 2.4")
Standards:	IEC 60947-4-1, IEC 60947-5-1, IEC 61095, EN 60947-4-1, EN 60947-5-1, EN 61095, EN 60947-1					

\* 3.8 VA/3.8 W for -04 version of contacts

\*\* Note: If several contactors are mounted close together a gap of 9 mm must be maintained between every other contactor.

\*\*\* HP rating: VS120 & VS220: 1-phase 1 HP|240 Vac, 1/3 HP|120 Vac; PD. B300, P300

VS325 & VS425: 1-phase 1 HP|240 Vac, 1/3 HP|120 Vac; 3-phase 3 HP|240 Vac, 5 HP|460 Vac; PD. B300, P300

VS340 & VS440: 1-phase 3 HP|240 Vac, 1 HP|120 Vac; 3-phase 7 HP|240 Vac, 15 HP|460 Vac; PD. B300, P300

VS363 & VS463: 1-phase 5 HP|240 Vac, 2 HP|120 Vac; 3-phase 10 HP|240 Vac, 20 HP|460 Vac; PD. B300, P300





EAN code  
see page 59

Technical parameters	VSM220	VSM425
Rated insulation voltage (Ui):	230 V	440 V
Rated thermo-current $I_{th}$ (in AC):	20 A	25 A
Voltage range:	50/60 Hz	50/60 Hz
<b>Switched operation</b>		
AC-1 for 400 V:	x	16 kW, 3 phase
AC-1 for 230 V:	4 kW, 1 phase	9 kW, 3 phase
AC-3 for 400 V:	x	4 kW, 3 phase
AC-3 for 230 V:	1.3 kW only NO, 1 phase	2.2 kW, 3 phase
AC-7a for 400 V:	x	16 kW, 3 phase
AC-7a for 230 V:	4 kW, 1 phase	9 kW, 3 phase
AC-7b for 400 V:	x	4 kW, 3 phase
AC-7b for 230 V:	1.3 kW only NO, 1 phase	2.2 kW, 3 phase
AC-15 for 400 V:	4 A	4 A
AC-15 for 230 V:	6 A	6 A
DC1 $U_e = 24$ V:	20 A	25 A
DC1 $U_e = 110$ V:	6 A	6 A
DC1 $U_e = 220$ V:	0.6 A	0.6 A
Loadability of modular contactors see page 58		
The max. number of switching for max. load:	600 switch/hr.	600 switch/hr.
<b>Electrical life in 230/400 V</b>		
AC-1- resistive load :	200.000	200.000
AC-3 - power load:	300.000	500.000
AC-5a - high-intensity discharge lamp:	100.000 by 30 $\mu$ F	100.000 by 36 $\mu$ F
AC-5b - incandescent lamps:	100.000 by 1.5 kW	100.000 by 1.5 kW
AC-7a - resistive household devices:	200.000	200.000
AC-7b - inductive household devices:	300.000	500.000
Minimal load:	$\geq 17$ V, $\geq 50$ mA	$\geq 17$ V, $\geq 50$ mA
Short circuit protection with the fuse char. aM:	20 A	25 A
Coordination Type according EN 60 947-4-1:	2	2
Electrical strenght:	4 kV	4 kV
<b>Contacts - max. cable size</b>		
Solid conductor:	AWG 7 (10 mm <sup>2</sup> )	AWG 7 (10 mm <sup>2</sup> )
Stranded conductor:	6 mm <sup>2</sup>	6 mm <sup>2</sup>
Maximal torque:	1.2 Nm	1.2 Nm
<b>Coil - max. cable size</b>		
Solid conductor:	AWG 10 (2.5 mm <sup>2</sup> )	AWG 10 (2.5 mm <sup>2</sup> )
Stranded conductor:	2.5 mm <sup>2</sup>	2.5 mm <sup>2</sup>
Max. torque:	0.6 Nm	0.6 Nm
<b>Operating</b>		
Coil control voltage:	AC 12 V, 24 V, 120 V, 230 V	AC 12 V, 24 V, 42 V, 230 V
Coil permanent supply +/- 10 %:	2.8 VA/1.2 W	5.5 VA/1.6 W
Coil gear supply +/- 10 %:	12 VA /10 W	33 VA/25 W
Mounting side-by-side:	max. 2 contactors*	max. 2 contactors*
Operational temperature:	-5 .. +55 °C (23 .. 131 °F)	
Storing temperature:	-30 .. +80 °C (-22 .. 176 °F)	
Weight:	140 g (4.9 oz.)	260 g (9.17 oz.)
Dimensions:	17.5 x 85 x 60 mm (0.7" x 3.35" x 2.4")	35 x 85 x 60 mm (1.4" x 3.35" x 2.4")
Standards:	IEC 60947-4-1, IEC 60947-5-1, IEC 61095, EN 60947-4-1, EN 61095, EN 60947-1	

\* Note: If several contactors are mounted close together a gap of 9 mm must be maintained between every other contactor.

- Special version of installation contactors with not only basic functions but also with manual control
- For switching electric circuits, especially for resistive loads and 3-phase induction motors
- Number of contacts **VSM220 - 2, VSM425 - 4**
- Description of individual positions of manual control:
  - AUTO: common function as with installation contactors without manual control
  - 1: shifting from AUTO to 1: operational contacts are closed and back contacts are open until there is another impulse to a contactor coil
  - 0: contacts are open (operational contact) or closed (stand-by contact) regardless voltage
- Optical indicator of state ON - OFF
- It is produced in configuration of making and breaking contacts:
  - VSM220:** 20, 11, 02
  - VSM425:** 40, 31, 22, 04
- Protection IP20 - on request we deliver covers that ensure protection IP40.
- It is possible to connect auxiliary contacts VSK to contactors VSM220, VSM425

#### Connection VSM220

VSM220 - only AC supply voltage

#### VSM220-20

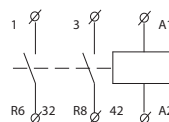

#### VSM220-11

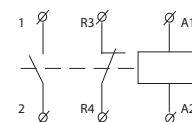

#### VSM220-02

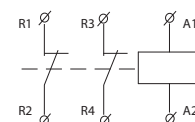

#### Connection VSM425

VSM425 - only AC supply voltage

#### VSM425-40

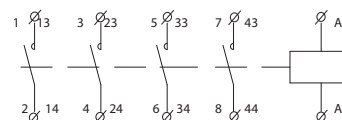

#### VSM425-31

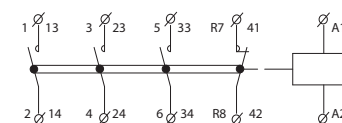

#### VSM425-22

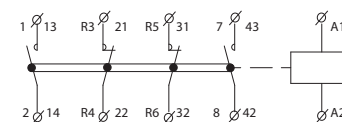

#### VSM425-04

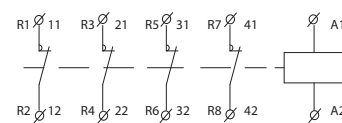

#### Auxiliary contacts VSK-11 and VSK-20

Datas of auxiliary contacts for VSK-11 and VSK-20 see page 57.

VS120

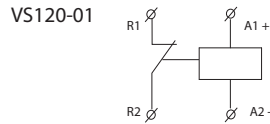
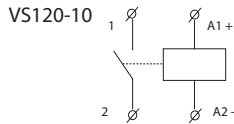

VS325

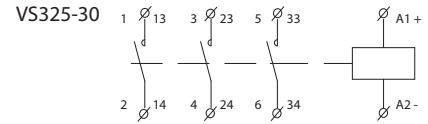

VS220

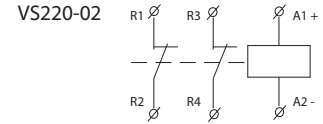
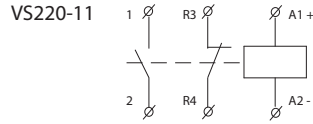
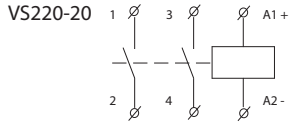

VS420

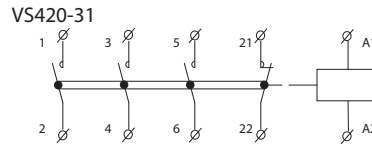
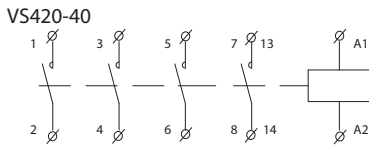

VS340

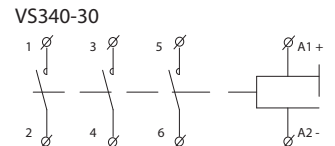

VS425

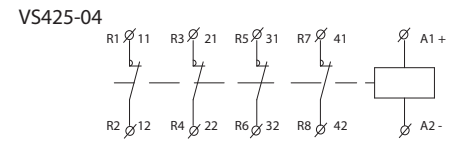
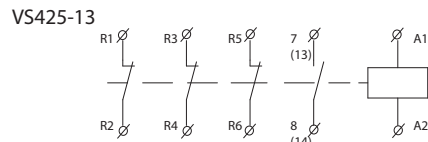
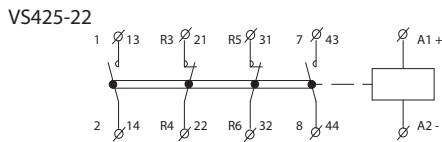
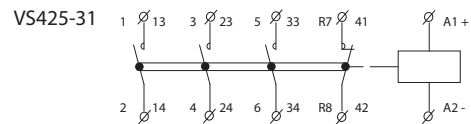
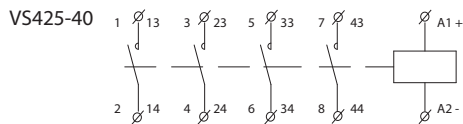

VS440

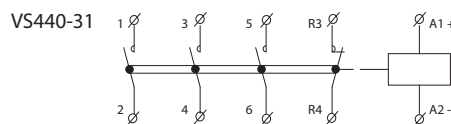
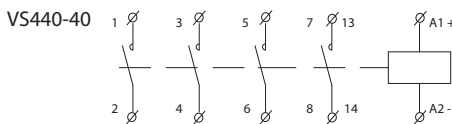

VS363

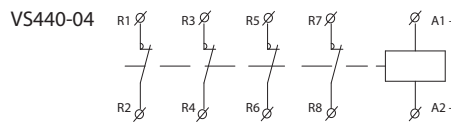
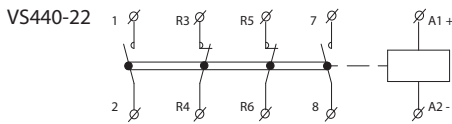
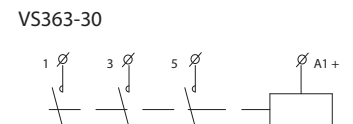

VS463

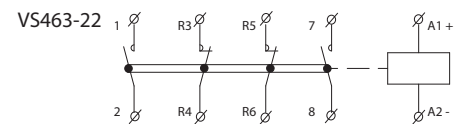
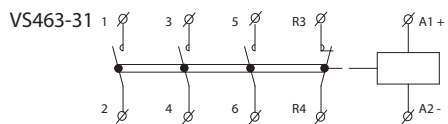
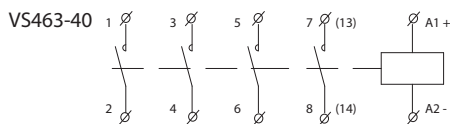

Auxiliary contacts for VS425, VS440, VS463 and VSM220, VSM425

Datas of auxiliary contacts for VSK-11 and VSK-20

Ambient temperature:	-5 .. +55 °C (23 .. 131 °F)
Rated insulation voltage (Ui):	500 V
Dielectric strength:	4 kV
Rated current 230 V (AC 15):	6 A
Rated current 400 V (AC 15):	4 A
Max. switching frequency:	6 A
The max. number of switching for max. load:	600 sep./hod.
Minimal load:	≥ 12 V, ≥ 10 mA
Short circuit protection with the fuse char. aM:	6 A
Solid/Stranded conductor (max):	2.5 mm <sup>2</sup> /2.5 mm <sup>2</sup> (AWG 10)
Maximal torque:	0.8 Nm
Weight:	10 g (0.35 oz.)
Dimensions:	10 x 85 x 60 mm (0.4" x 3.35" x 2.4")

Connection of auxiliary contact VSK-11 and VSK-20

EAN code see page 59

VSK-11



VSK-20

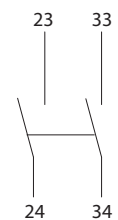

## Loadability of installation contactors

TYPE OF LIGHT	OUTPUT (W)	I (A)	Number of lights on one contactor's contact							
			VS120	VS220	VS420	VS425	VS440	VS463	VSM220	VSM425
Incandescent lamps	60	0.26	33	33	33	33	65	85	33	33
	100	0.43	20	20	20	20	40	50	20	20
	200	0.87	10	10	10	10	20	25	10	10
	500	2.17	3	3	3	3	8	10	3	3
	1000	4.35	1	1	1	1	4	5	1	1
Flourescent lamps	18	0.37	22	22	22	24	90	140	22	24
	24	0.35	22	22	22	24	90	140	22	24
	36	0.43	17	17	17	20	65	95	17	20
	58	0.67	14	14	14	17	45	70	14	17
Flourescent lamps lead-lag circuit	18	0.11	2 x 30	2 x 30	2 x 30	2 x 40	2 x 100	2 x 150	2 x 30	2 x 40
	24	0.14	2 x 24	2 x 24	2 x 24	2 x 31	2 x 78	2 x 118	2 x 24	2 x 31
	36	0.22	2 x 17	2 x 17	2 x 17	2 x 24	2 x 65	2 x 95	2 x 17	2 x 24
	58	0.35	2 x 10	2 x 10	2 x 10	2 x 14	2 x 40	2 x 60	2 x 10	2 x 14
Flourescent lamps parallel correction	18	0.12	7	7	7	8	48	73	7	8
	24	0.15	7	7	7	8	48	73	7	8
	36	0.2	7	7	7	8	48	73	7	8
	58	0.32	4	4	4	5	31	47	4	5
Flourescent lamps with electronic ballast units (EVG)	1 x 18	0.09	25	25	25	35	100	140	25	35
	1 x 36	0.16	15	15	15	20	52	75	15	20
	1 x 58	0.25	14	14	14	19	50	72	14	19
	2 x 18	0.17	12	12	12	17	50	70	12	17
	2 x 36	0.32	7	7	7	10	26	38	7	10
	2 x 58	0.49	7	7	7	9	25	36	7	9
High-pressure mercury-vapour lamps uncorrected	50	0.61	14	14	14	18	38	55	14	18
	80	0.8	10	10	10	13	29	42	10	13
	125	1.15	7	7	7	9	20	29	7	9
	250	2.15	4	4	4	5	10	15	4	5
	400	3.25	2	2	2	3	7	10	2	3
	700	5.4	1	1	1	2	4	6	1	2
	1000	7.5	1	1	1	1	3	4	1	1
High-pressure mercury-vapour lamps parallel correction	50	0.28	4	4	4	5	31	47	4	5
	80	0.41	4	4	4	5	27	41	4	5
	125	0.65	3	3	3	4	22	33	3	4
	250	1.22	1	1	1	2	12	18	1	2
	400	1.95	1	1	1	1	9	13	1	1
	700	3.45	-	-	-	-	5	7	-	-
	1000	4.8	-	-	-	-	4	5	-	-
Halogen metal vapour lamps uncorrected	35	0.53	18	18	18	22	43	60	18	22
	70	1	10	10	10	12	23	32	10	12
	150	1.8	5	5	5	7	12	18	5	7
	250	3	3	3	3	4	7	10	3	4
	400	3.5	3	3	3	3	6	9	3	3
	1000	9.5	1	1	1	1	2	3	1	1
	2000	16.5	-	-	-	-	1	1	-	-
Halogen metal-vapour lamps parallel correction	35	0.25	5	5	5	6	36	50	5	6
	70	0.45	2	2	2	3	18	25	2	3
	150	0.75	1	1	1	1	11	15	1	1
	250	1.5	-	-	-	1	6	9	-	1
	400	2.5	-	-	-	1	6	8	-	1
	1000	5.8	-	-	-	-	2	3	-	-
	2000	11.5	-	-	-	-	1	2	-	-
High-pressure sodium-vapour lamps uncorrected	150	1.8	5	5	5	6	17	22	5	6
	250	3	3	3	4	10	13	3	4	
	400	4.7	2	2	2	6	8	2	2	
	1000	10.3	-	-	-	1	3	3	-	1
High-pressure sodium-vapour lamps parallel correction	150	0.83	1	1	1	1	11	16	1	1
	250	1.5	-	-	-	1	6	10	-	1
	400	2.4	-	-	-	-	4	6	-	-
	1000	6.3	-	-	-	-	2	3	-	-
Low-pressure sodium-vapour lamps uncorrected	18	0.35	22	22	22	27	71	90	22	27
	35	1.5	7	7	7	9	23	30	7	9
	55	1.5	7	7	7	9	23	30	7	9
	90	2.4	4	4	4	5	14	19	4	5
	135	3.5	3	3	3	4	10	13	3	4
	180	3.3	3	3	3	4	10	13	3	4
Low-pressure sodium-vapour lamps parallel correction	18	0.35	6	6	6	7	44	66	6	7
	35	0.31	1	1	1	1	11	16	1	1
	55	0.42	1	1	1	1	11	16	1	1
	90	0.63	1	1	1	1	8	12	1	1
	135	0.94	-	-	-	-	4	7	-	-
	180	1.16	-	-	-	-	5	8	-	-

**EAN codes for VS**



<b>VS120</b>	<b>VS425</b>
VS120-01 24V AC/DC: 8595188129848	VS425-04 24V AC/DC: 8595188129527
VS120-01 230V AC/DC: 8595188123105	VS425-04 48V AC/DC: 8595188129558
	VS425-04 120V AC/DC: 8595188160032
VS120-10 24V AC/DC: 8595188129367	VS425-04 230V AC/DC: 8595188121682
VS120-10 230V AC/DC: 8595188123112	
	VS425-13 230V AC/DC: 8595188129473
<b>VS220</b>	VS425-22 24V AC/DC: 8595188129541
VS220-02 24V AC/DC: 8595188129381	VS425-22 230V AC/DC: 8595188121675
VS220-02 120V AC/DC: 8595188138628	
VS220-02 230V AC/DC: 8595188121422	VS425-31 24V AC/DC: 8595188129497
	VS425-31 48V AC/DC: 8595188137898
VS220-11 24V AC/DC: 8595188129374	VS425-31 120V AC/DC: 8595188129534
VS220-11 48V AC/DC: 8595188129398	VS425-31 230V AC/DC: 8595188121668
VS220-11 120V AC/DC: 8595188130790	
VS220-11 230V AC/DC: 8595188121408	VS425-40 24V AC/DC: 8595188129480
	VS425-40 48V AC/DC: 8595188136174
VS220-20 24V AC/DC: 8595188125253	VS425-40 230V AC/DC: 8595188121651
VS220-20 48V AC/DC: 8595188129411	
VS220-20 120V AC/DC: 8595188129428	<b>VS440</b>
VS220-20 230V AC/DC: 8595188121392	VS440-04 24V AC/DC: 8595188129299
<b>VS420</b>	VS440-04 120V AC/DC: 8595188129305
VS420-31 24V AC: 8595188129442	VS440-04 230V AC/DC: 8595188121484
VS420-31 120V AC: 8595188129466	
VS420-31 230V AC: 8595188121446	VS440-22 24V AC/DC: 8595188129787
	VS440-22 230V AC/DC: 8595188121477
VS420-40 12V AC: 8595188129459	VS440-31 24V AC/DC: 8595188129572
VS420-40 24V AC: 8595188129435	VS440-31 230V AC/DC: 8595188121460
VS420-40 48V AC: 8595188138581	
VS420-40 230V AC: 8595188121439	VS440-40 24V AC/DC: 8595188129565
<b>VS463</b>	VS440-40 120V AC/DC: 8595188138567
VS463-22 24V AC/DC: 8595188129794	VS440-40 230V AC/DC: 8595188121453
VS463-22 230V AC/DC: 8595188121514	
VS463-31 24V AC/DC: 8595188129596	
VS463-31 120V AC/DC: 8595188137904	
VS463-31 230V AC/DC: 8595188121507	
VS463-40 24V AC/DC: 8595188129589	
VS463-40-48V AC/DC: 8595188160612	
VS463-40 120V AC/DC: 8595188140652	
VS463-40 230V AC/DC: 8595188121491	

**EAN codes for VSM**

<b>VSM220</b>	<b>VSM425</b>
VSM220-02 24V AC: 8595188129817	VSM425-04 24V AC: 8595188129831
VSM220-02 230V AC: 8595188128100	VSM425-04 230V AC: 8595188128155
VSM220-11 24V AC: 8595188129800	VSM425-22 24V AC: 8595188129336
VSM220-11 230V AC: 8595188128094	VSM425-22 230V AC: 8595188128148
VSM220-20 12V AC: 8595188138369	VSM425-31 24V AC: 8595188129824
VSM220-20 24V AC: 8595188128117	VSM425-31 230V AC: 8595188128131
VSM220-20 120V AC: 8595188160223	
VSM220-20 230V AC: 8595188128087	VSM425-40 12V AC: 8595188160049
	VSM425-40 24V AC: 8595188128162
	VSM425-40 230V AC: 8595188128124

**EAN codes for VSK and covers**

VSK-11: 8595188121613  
 VSK-20: 8595188121606

**EAN codes for VS**



<b>VS120</b>	<b>VS440</b>
VS120-10UL 230V AC/DC: 8595188189880	VS440-40UL 230V AC/DC: 8595188190121
VS120-10UL 120V AC/DC: 8595188189897	VS440-40UL 120V AC/DC: 8595188190138
VS120-10UL 24V AC/DC: 8595188189903	VS440-40UL 24V AC/DC: 8595188190145
VS120-01UL 230V AC/DC: 8595188189910	VS440-31UL 230V AC/DC: 8595188190152
VS120-01UL 120V AC/DC: 8595188189927	VS440-31UL 120V AC/DC: 8595188190169
VS120-01UL 24V AC/DC: 8595188189934	VS440-31UL 24V AC/DC: 8595188190176
<b>VS220</b>	
VS220-20UL 230V AC/DC: 8595188189828	VS440-22UL 230V AC/DC: 8595188190213
VS220-20UL 120V AC/DC: 8595188189835	VS440-22UL 120V AC/DC: 8595188190220
VS220-20UL 24V AC/DC: 8595188189842	VS440-22UL 24V AC/DC: 8595188190237
VS220-11UL 230V AC/DC: 8595188189859	VS440-04UL 230V AC/DC: 8595188190244
VS220-11UL 120V AC/DC: 8595188189866	VS440-04UL 120V AC/DC: 8595188190251
VS220-11UL 24V AC/DC: 8595188189873	VS440-04UL 24V AC/DC: 8595188190268
	<b>VS363</b>
VS220-02UL 230V AC/DC: 8595188189941	VS363-30UL 230V AC/DC: 8595188190336
VS220-02UL 120V AC/DC: 8595188189958	VS363-30UL 120V AC/DC: 8595188190343
VS220-02UL 24V AC/DC: 8595188189965	VS363-30UL 24V AC/DC: 8595188190350
<b>VS325</b>	<b>VS463</b>
VS325-30UL 230V AC/DC: 8595188190039	VS463-40UL 230V AC/DC: 8595188190275
VS325-30UL 120V AC/DC: 8595188190046	VS463-40UL 120V AC/DC: 8595188190282
VS325-30UL 24V AC/DC: 8595188190053	VS463-40UL 24V AC/DC: 8595188190299
<b>VS425</b>	VS463-31UL 230V AC/DC: 8595188190305
VS425-40UL 230V AC/DC: 8595188189972	VS463-31UL 120V AC/DC: 8595188190312
VS425-40UL 120V AC/DC: 8595188189989	VS463-31UL 24V AC/DC: 8595188190329
VS425-40UL 24V AC/DC: 8595188189996	
	VS463-22UL 230V AC/DC: 8595188190367
VS425-31UL 230V AC/DC: 8595188190008	VS463-22UL 120V AC/DC: 8595188190374
VS425-31UL 120V AC/DC: 8595188190015	VS463-22UL 24V AC/DC: 8595188190381
VS425-31UL 24V AC/DC: 8595188190022	
VS425-22UL 230V AC/DC: 8595188190060	
VS425-22UL 120V AC/DC: 8595188190077	
VS425-22UL 24V AC/DC: 8595188190084	
VS425-04UL 230V AC/DC: 8595188190091	
VS425-04UL 120V AC/DC: 8595188190107	
VS425-04UL 24V AC/DC: 8595188190114	
<b>VS340</b>	
VS340-30UL 230V AC/DC: 8595188190183	
VS340-30UL 120V AC/DC: 8595188190190	
VS340-30UL 24V AC/DC: 8595188190206	



MR-41

Voltage range: AC 230 V or AC/DC 12 -240 V  
Output contact: 1x changeover/SPDT 16 A.  
page 61



MR-42

Voltage range: AC 230 V or AC/DC 12 -240 V  
Output contact: 2x changeover/DPDT 16 A.  
page 61

TWILIGHT AND LIGHT SWITCHES



SOU-1

Twilight switch. Voltage range: AC 230 V or AC/DC 12-240 V. Output contact: 1x changeover/SPDT 16 A.  
page 64



SOU-2

Twilight switch with digital time switch. Voltage range: AC 230 V. Output contact: 1x changeover/SPDT 8 A.  
page 65



SOU-3

Twilight and light switch. Voltage range: AC 230 V. Output contact: 1x NO/SPST 16 A.  
page 66



BR-216-10

Number of contacts: 1x 16 A.  
Contact configuration: 10.  
page 62



BR-216-11

Number of contacts: 2x 16 A.  
Contact configuration: 11.  
page 62



BR-216-20

Number of contacts: 2x 16 A.  
Contact configuration: 20.  
page 62



BR-220-20

Number of contacts: 2x 20 A.  
Contact configuration: 20.  
page 62



BR-232-20

Number of contacts: 2x 32 A.  
Contact configuration: 20.  
page 62

Accessories for SOU-1



SKS-100

Photosensor suitable for mounting on the wall or in panel.  
Protection degree: IP65.  
EAN code: 8595188180733



PLUG-IN backup battery module

Suitable for backup battery type CR2032 (3V)  
EAN code: 209930603123



SKS-200

Photosensor suitable for mounting on the wall or in panel.  
Protection degree: IP65.  
EAN code: 8595188182331



EAN code  
 MR-41/230 V: 8595188115889  
 MR-41/UNI: 8595188115896  
 MR-42/230 V: 8595188182492  
 MR-42/UNI: 8595188182256

Technical parameters	MR-41	MR-42
Number of functions:	1	2
Supply terminals:	A1 - A2	
Voltage range:	AC/DC 12 - 240 V (AC 50 - 60 Hz)	
Consumption (max.):	2 VA/1.5 W	2.5 VA/1.5 W
Voltage range:	AC 230 V (50 - 60 Hz)	
Consumption (max.):	3 VA/1.4 W	4 VA/2 W
Supply voltage tolerance:	-15 %; +10 %	
Supply indication:	green LED	
<b>Output</b>		
Number of contacts:	1x changeover/SPDT (AgSnO <sub>2</sub> )	2x changeover/DPDT (AgSnO <sub>2</sub> )
Current rating:	16 A/AC1; 1 HP 240 Vac, 1/2 HP 120 Vac; PD. B300	
Breaking capacity:	4000 VA/AC1, 384 W/DC	
Inrush current:	30 A/< 3 s	
Switching voltage:	250V AC/24V DC	
Power dissipation (max.):	1.2 W	2.4 W
Output indication:	red LED	
Mechanical life:	10.000.000 ops.	
Electrical life (AC1):	100.000 ops.	
<b>Controlling</b>		
Load between A2-ON/OFF:	Yes	
Control terminals:	A1 - ON/OFF	
Glow-lamp connection:	(UNI) - NO, (230) - max. 4 pcs	
Impulse length:	min. 25 ms/max. unlimited	
<b>Other data</b>		
Operating temperature:	-20 .. +55 °C (-4 .. 131 °F)	
Storage temperature:	-30 .. +70 °C (-22 .. 158 °F)	
Dielectric strength:		
supply - output 1	4 kV	
supply - output 2	-	
output 1 - output 2	3 kV	
output 1 - output 2	-	
output 1 - output 2	4 kV	
Operating position:	any	
Mounting:	DIN rail EN 60715	
Protection degree:	IP40 from front panel/IP20 terminals	
Overvoltage category:	III.	
Pollution degree:	2	
Max. cable size (mm <sup>2</sup> ):	solid wire max. 1x 2.5 or 2x 1.5/ with sleeve max. 1x 2.5 (AWG 12)	
Dimensions:	90 x 17.6 x 64 mm (3.5" x 0.7" x 2.5")	
Weight:	(UNI)-59 g (2.3 oz.), (230)-53 g (2.2 oz.)	(UNI)-80 g (2.8 oz.), (230)-70 g (2.5 oz.)
Standards:	EN 60669-1, EN 60669-2-1	

Symbol



- Memory (impulse) relays, controlled by buttons from several locations can replace three way switches or cross bar switches.
- Thanks to control by buttons (unlimited number, connected in parallel by 2 wires), installation gets more transparent and faster for mounting.
- Relays MR-41, MR-42 memorize its last state even after supply failure. During the failure relay will turn off and after re-energizing will automatically turns on.
- MR-41 - output contact: 1x changeover 16 A.
- MR-42 - options: 2x parallel contacts or the other relay is latching  
 - function selected via potentiometer on front panel  
 - output contact: 2x changeover 16 A
- Supply voltage: AC 230 V or AC/DC 12 - 240 V.

Description

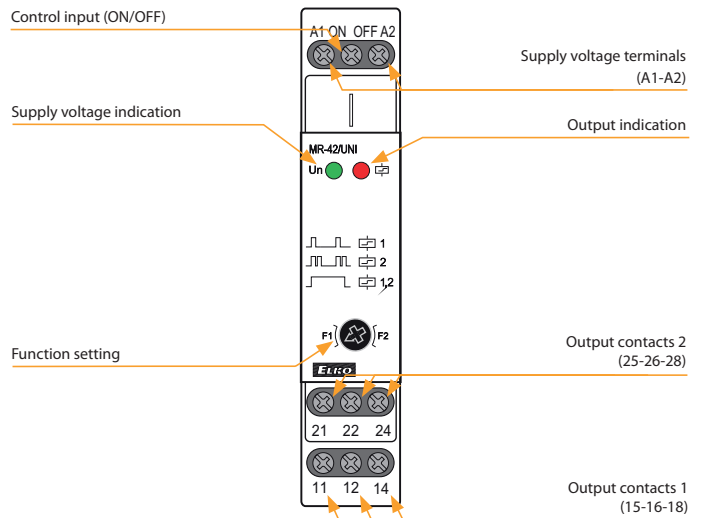

Connection

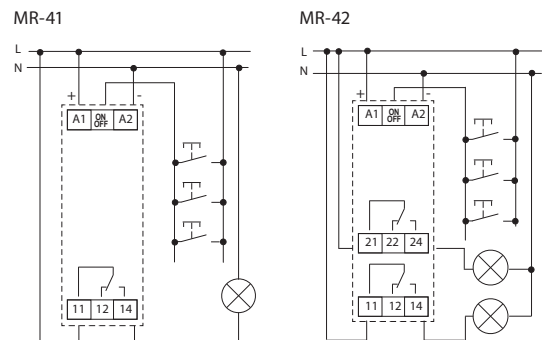

Function

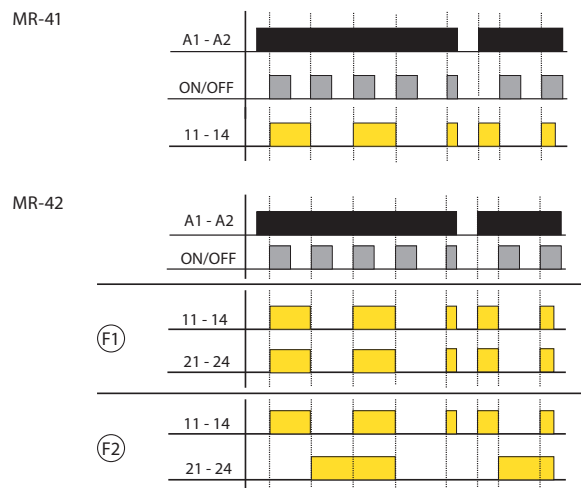





- Bistable relays are used to switch electrical circuits by impulse command, especially for lighting control in ordinary houses, warehouses, production halls and other buildings.
- Faster and easier installation thanks to an unlimited number of buttons, connected in parallel by two wires, which is a practical replacement for AC and cross switches.
- Last but not least, they offer savings in the number of wires used and, in the case of the control circuit, the possibility of using wires with a smaller cross-section, where the power input is minimal compared to the power circuit.
- The state of the Bistable relay changes with a short control pulse. As a result of which the relay in the steady state has zero consumption.
- All relays can be controlled manually using a switch on the relay panel (I-O), which also serves as to signal the status of the contacts.
- For types BR-220 and BR-232, it is possible to disconnect the electrical switch control and as a result the state of the relay can then only be changed manually (service, maintenance).

EAN code  
 BR-216-10/230V: 8595188168854  
 BR-216-11/230V: 8595188168878  
 BR-216-20/230V: 8595188168861  
 BR-220-20/230V: 8595188168885  
 BR-232-20/230V: 8595188168892

Technical parameters	BR-216-10/11/20	BR-220-20	BR-232-20
<b>Main circuit (contact)</b>			
Rated insulation voltage (U <sub>i</sub> ):		440 V	
Thermal current (I <sub>th</sub> ):	16 A	20 A	32 A
Number of poles:	1, 2, 2	2	2
Contact configuration:	10, 11, 20	20	20
Operational Power (P <sub>o</sub> )			
AC-1, AC-7a for 230 V, 1 phase:	3.5 kW	4.4 kW	7 kW
AC-2 for 230 V, 1 phase:	1.2 kW	1.5 kW	2.4 kW
AC-3, AC-7b for 230V, 1 phase:	0.37 kW	0.55 kW	1.1 kW
DC-1 (L/R ≤ 1 ms)			
U <sub>e</sub> = 24V (1 contact/2 contacts in series):	16 A/16 A	20 A/20 A	32 A/32 A
U <sub>e</sub> = 48V (1 contact/2 contacts in series):	12 A/5 A	15 A/18 A	25 A/28 A
U <sub>e</sub> = 60V (1 contact/2 contacts in series):	8 A/14 A	10 A/15 A	20 A/22 A
U <sub>e</sub> = 110V (1 contact/2 contacts in series):	4 A/7 A	5 A/8 A	7 A/12 A
U <sub>e</sub> = 220V (1 contact/2 contacts in series):	0.4 A/3 A	0.5 A/4 A	0.7 A/6 A
Load capacity of light sources AC-5a, AC-5b			
Max. operating frequency (op./hr)			
without load:	900	900	450
AC-1, AC-7a:	600	600	450
AC-2:	120	120	120
AC-3, AC-7b:	600	600	450
AC-5a, AC-5b:	600	600	450
DC-1:		300	
Electrical endurance: DC-1, DC-3, DC-5, AC-1, AC-7a, AC-2, AC-3, AC-7b, AC-5a / AC-5b (I <sub>e</sub> = 10 A):		100 000 op. c.	
Mechanical lifetime:		1 000 000 op. C	
Power dissipation per pole:	1 W	1.5 W	3 W
Contact reliability:		>10 V, >100 mA	
Max. back-up fuse against short circuit gL/gG (I <sub>v</sub> ) - coordination type 1:	16 A	20 A	32 A
Rated impulse withstand voltage (U <sub>imp</sub> ):		4 kV	
Overload current withstand capability: 10s:	48 A	56 A	80 A
Terminal capacity (solid and stranded):		1 to 10 mm <sup>2</sup>	
Maximum tightening torque:		1.2 Nm	
Screw head:		PZ2	
<b>Control circuit (coil)</b>			
Rated control voltage:	AC 230 V		AC 120 V
Rated frequency:	50 Hz		60 Hz
Impulse duration:		min. 50 ms/max. 1 h	
Duration between two impulses (of control voltage):		min. 150 ms	
Maximum load of illuminated buttons (glow lamps, LEDs,...):		2,5 mA	
Terminal capacity (solid and stranded):		1 to 4 mm <sup>2</sup>	
Maximum tightening torque:		0.6 Nm	
Screw head:		PZ1	
<b>General</b>			
Mounting:	DIN Rail, TH35 (IEC/EN 60715)		
Number of contactors or switches side-by-side:	no limitation under 55 °C (55 .. 70 °C max. 3)/ 131 °F (131 °F .. 158 °F)		
Degree of protection:	IP20		
Operational temperature:	-25 .. +55 °C (> 55 .. +70 °C at max. pulse length - 1min) (13 .. 131 °F (> 131 .. 158 °C at max. pulse length - 1min))		
Storing temperature:	-30 .. +80 °C (-22 °F to 176 °F)		
Disconnection of remote control (coil) by switch:	no	yes	yes
Standards:	IEC/EN 60669-2-2		

### Connection

#### BR-216-10

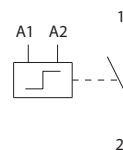

#### BR-216-11

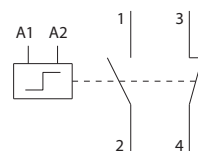

#### BR-216-20

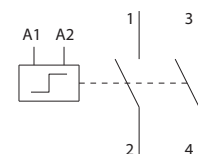

#### BR-220-20

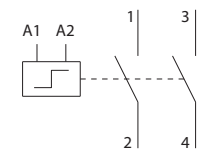

#### BR-232-20

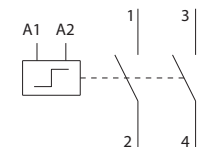

### Example of connection BR-216-10

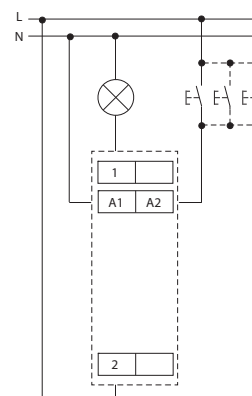

Lamps Type	Power	Current	Capacity	Maximum number of lamps per pole			
	P (W)	I (A)	C (μF)	BR-216-10/11/20	BR-220-20	BR-232-20	
LED lamps Power supplies for LEDs	-	-	-	max. 2 A per pole	max. 6 A per pole	max. 12 A per pole	
Incandescent lamps and halogen lamps	15	0,07	-	133	133	233	
	25	0,11	-	80	80	140	
	40	0,17	-	50	50	88	
	60	0,26	-	33	33	58	
	75	0,33	-	27	27	47	
	100	0,44	-	20	20	35	
	150	0,65	-	13	13	23	
	200	0,87	-	10	10	18	
	300	1,3	-	7	7	12	
Fluorescent lamps with external electromagnetic ballasts - uncorrected	500	2,17	-	4	4	7	
	1000	4,35	-	2	2	4	
	18	0,37	-	43	43	43	
	36	0,43	-	37	37	37	
	58	0,67	-	24	24	24	
	Fluorescent lamps with external electromagnetic ballasts - parallel corrected	18	0,19	4,5	18	22	33
		36	0,29	4,5	18	22	33
		58	0,46	7	11	14	21
	Lead-lag circuit for fluorescent lamps with external electromagnetic ballasts - series corrected	2x18	0,26	2,7	62	62	62
2x36		0,48	4,5	33	33	33	
2x58		0,78	7	21	21	21	
Fluorescent lamps with external electronic ballasts	18	0,09	-	33	67	133	
	2x18	0,17	-	18	35	71	
	36	0,16	-	19	38	75	
	2x36	0,31	-	10	19	39	
	58	0,25	-	12	24	48	
	2x58	0,48	-	6	13	25	
	80	0,4	-	8	15	30	
	2x80	0,76	-	4	8	16	
High pressure mercury vapour lamps with external electromagnetic ballasts - uncorrected	50	0,6	-	17	27	27	
	80	0,8	-	13	20	20	
	125	1,2	-	8	13	13	
	250	2,2	-	5	7	7	
	400	3,3	-	3	5	5	
	700	5,4	-	2	3	3	
	1000	7,5	-	1	2	2	
High pressure mercury vapour lamps with external electromagnetic ballasts - parallel corrected	50	0,3	7	11	14	21	
	80	0,4	8	10	13	19	
	125	0,6	10	8	10	15	
	250	1,2	18	4	6	8	
	400	1,8	25	3	4	6	
	700	3,4	40	2	3	4	
Metal halide lamps with external electromagnetic ballasts - uncorrected	1000	4,8	60	1	2	3	
	35	0,5	-	16	32	32	
	70	1	-	8	16	16	
	150	1,8	-	4	9	9	
	250	3	-	3	5	5	
	400	4,6	-	2	3	3	
Metal halide lamps with external electromagnetic ballasts - parallel corrected	1000	9,7	-	1	2	2	
	2000	12,2	-	0	1	1	
	35	0,23	6	13	17	25	
	70	0,42	12	7	8	13	
	150	0,77	20	4	5	8	
	250	1,26	32	3	3	5	
High pressure sodium vapour lamps with external electromagnetic ballasts - uncorrected	400	2	45	2	2	3	
	1000	5	85	0	1	2	
	2000	10,5	125	0	0	1	
	150	1,8	-	7	9	9	
	250	3	-	4	5	5	
High pressure sodium vapour lamps with external electromagnetic ballasts - parallel corrected	400	4,4	-	3	4	4	
	1000	10,3	-	1	1	1	
	150	0,77	20	4	5	8	
	250	1,26	32	3	3	5	
High pressure sodium vapour lamps with external electronic ballasts	400	2	45	2	2	3	
	1000	5,1	100	0	0	1	
	150	0,72	-	4	8	17	
	250	1,3	-	2	5	9	
Low pressure sodium vapour lamps with external electromagnetic ballasts - uncorrected	400	2	-	2	3	6	
	1000	5	-	0	1	2	
	18	0,4	-	25	40	40	
	35	0,6	-	15	27	27	
	55	0,6	-	15	27	27	
	90	0,9	-	10	18	18	
Low pressure sodium vapour lamps with external electromagnetic ballasts - parallel corrected	135	0,9	-	10	18	18	
	180	0,9	-	10	18	18	
	18	0,35	5	16	20	30	
	35	0,28	20	4	5	8	
	55	0,35	20	4	5	8	
	90	0,55	26	3	4	6	
Low pressure sodium vapour lamps with external electromagnetic ballasts - parallel corrected	135	0,8	40	2	3	4	
	180	1	40	2	3	4	



EAN code  
SOU-1/230V + SKS-100: 8595188121002  
SOU-1/UNI + SKS-100: 8595188180467  
Photosensor SKS-100: 8594030337288

Technical parameters		SOU-1
Supply terminals:		A1 - A2
Voltage range:	UNI	AC/DC 12 - 240 V (AC 50-60 Hz)
Power input max.:		AC 1.5 VA/0.9 W
Voltage range:	230	AC 230 V (50-60 Hz)
Power input max.:		3 VA/2 W
Max. dissipated power (Un + terminals):		4 W
Supply voltage tolerance:		-15 %; +10 %
Supply indication:		green LED
Time delay:		0 - 2 min
Time delay setting:		potentiometer
Illumination range LUX1:		1 - 100 Lx
Illumination range LUX2:		100 - 50 000 Lx
Output		
Number of contacts:		1x changeover (AgSnO <sub>2</sub> )
Current rating:		16 A/AC1; 1 HP 240 Vac, 1/2 HP 120 Vac; PD. B300
Breaking capacity:		4000 VA/AC1, 384 W/DC
Inrush current:		30 A/< 3 s
Switching voltage:		250 V AC/24 V DC
Output indication:		red LED
Mechanical life:		10.000.000 ops.
Electrical life (AC1):		100.000 ops.
Control		
Power the control input:		0.3 W
Load between S-A2:		yes
Control. terminals:		A1 - S
Impulse length:		min. 25 ms/max. unlimited
Reset time:		150 ms
Other information		
Operating temperature:		-20 .. +55 °C (-4 .. 131 °F)
Storage temperature:		-30 .. +70 °C (-22 .. 158 °F)
Dielectric strength:		4 kV (supply - output)
Operating position:		any
Mounting:		DIN rail EN 60715
Protection degree:		IP40 from front panel/IP20 terminals
Sensor cable length:		max. 50 m (standard wire)
Overtoltage category:		III.
Pollution degree:		2
Max. cable size (mm <sup>2</sup> ):		solid wire max. 1x 2.5 or 2x 1.5/ with sleeve max. 1x 2.5 (AWG 12)
Dimensions:		90 x 17.6 x 64 mm (3.5 x 0.7 x 2.5 inch)
Weight:		(UNI): 66 g (2.3 oz.)/(230 V): 63 g (2.2 oz.)
Dimensions of sensor SKS-100:		58 x Ø 24 mm (2.3" x Ø 0.9")
Weight of sensor SKS-100:		20 g (0.5 oz.)
Standards:		EN 60669-1, EN 60669-2-1

- Is used to control lights on the basis of ambient light intensity.
- Used for switching street illumination and garden lights, illumination of advertisements, shop windows, etc.
- Level of ambient intensity is monitored by an external sensor SKS-100 and output is switched according to set level on the device.
- Control input for additional control, e.g. time switch, preswitch etc.
- Level of illumination adjustable in two ranges:  
1 - 100 lx and 100 - 50000 lx.
- Adjustable time delay to eliminate short term fluctuation in illumination.
- External sensor IP65 suitable for mounting on the wall (cover and holder of a sensor are a part of the package).

## Description

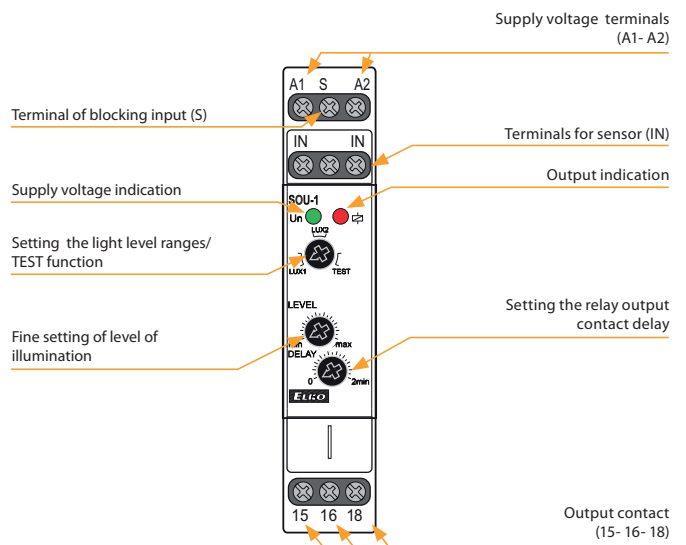

LUX1: Range 1 - 100 Lx.

LUX2: Range 100 - 50 000 Lx.

TEST: By switching to position TEST all function are switched off and switching contacts of output relay are switched on. The function TEST is used for testing of right connection of load and for verification of failure (breaking of the bulb).

## Connection

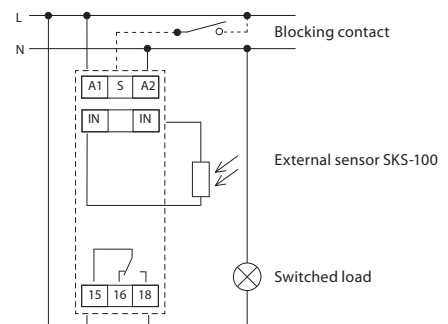

**nutno dodržet správnost připojení přístroje do el. sítě**  
tzn. A1 = fáze (L) a A2 pracovní nulový vodič

## Function

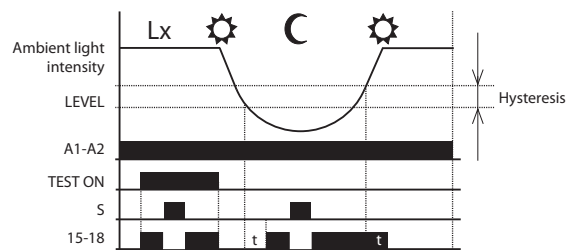



EAN code  
 SOU-2 + SKS-200: 8595188182348  
 SOU-2: 8595188182355  
 Photosensor SKS-200: 8595188182331

Technical parameters		SOU-2
Supply terminals:	A1 - A2	
Supply voltage:	AC 230 V (50-60 Hz)	
Consumption (max.):	4 VA/1.7 W	
Supply voltage tolerance:	-15 %; +10 %	
Backup battery type:	CR 2032 (3V)	
<b>Output</b>		
Number of contacts:	1x changeover (AgSnO <sub>2</sub> )	
Current rating:	8 A/AC1; 1/2 HP 240 Vac, PD. B300	
Breaking capacity:	2000 VA/AC1, 240 W/DC	
Switching voltage:	250V AC/30V DC	
Power dissipation (max.):	0.6 W	
Mechanical life:	30.000.000 ops.	
Electrical life (AC1):	100.000 ops.	
<b>Time circuit</b>		
Accuracy:	max. ±1 s day (23 °C/73.4 °F)	
Minimum switching interval:	1 min	
Program data storage period:	min. 10 year	
<b>Program circuit</b>		
Adjustable light intensity:	10-50000 lx	
Sensor failure indication:	displayed on LCD*	
Number of memory locations:	100	
Program:	daily, weekly, yearly	
<b>Other information</b>		
Operating temperature:	-10 .. +55 °C (-4 .. 131 °F)	
Storage temperature:	-30 .. +70 °C (-22 .. 158 °F)	
Dielectric strength:	4 kV (supply - output) 3.5 kV (supply - sensor)	
Operating position:	any	
Mounting:	DIN rail EN 60715	
Protection degree:	IP40 from front panel/IP20 terminals	
Overvoltage category:	III.	
Pollution degree:	2	
Max. cable size (mm <sup>2</sup> ):	max. 1x 2.5, max. 2x 1.5/ with sleeve max. 1x 1.5	
Dimensions:	90 x 35 x 64 mm (3.5" x 1.4" x 2.5")	
Weight:	142 g (5 oz.)	
Sensor dimensions SKS-200:	58 x Ø 24 mm (2.3" x Ø 0.9")	
Sensor weight SKS-200:	16 g (0.5 oz.)	
Standards:	EN 61812-1, EN 60669-1, EN 60669-2-1	

\* ERROR - sensor short circuit

- Is used for control of lights on the basis of ambient light intensity and real time (combination of SOU-1 and time switch SHT-3 in one device).
- Time clock can override the light sensor for applications when lights are not required.
- Switching: according to a program (AUTO)/permanently manual/random (CUBE).
- External sensor IP65 issuitable for mounting on the wall/in panel (cover and sensors are part of delivery).
- Sealable transparent cover of front panel.
- Backup of data and time by battery (up to 3 years).
- Easy replacement of backup battery with plug-in module located on front panel of device (no disassembly required).

### Description

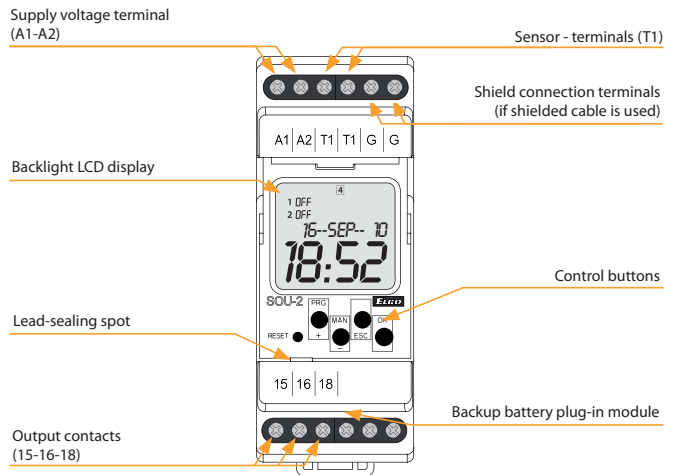

### Description of visual elements on the display

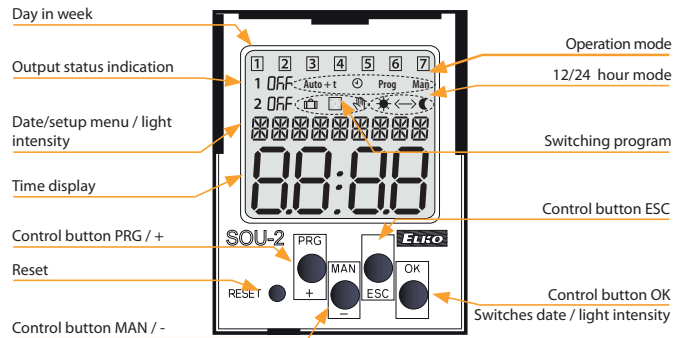

### Connection

### Symbol

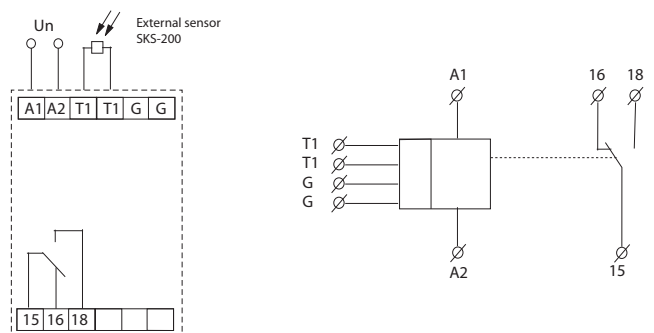



 EAN code  
 SOU-3/230V: 8595188140560

Technical parameters		SOU-3
<b>Supply</b>		
Supply terminals:	L - N	
Voltage range:	AC 230 V (50-60 Hz)	
Input (apparent/loss):	max. 6 VA/0.7 W	
Max. dissipated power (Un + terminals):	2.5 W	
Tolerance of voltage range:	- 15 % to +10 %	
<b>Setting the scale level of lighting</b>		by jumper J2
Function ☾ (twilight switch)		
range 1:	1 to 10 lx	
range 2:	10 to 100 lx	
range 3:	100 to 1.000 lx	
Function ☀ (light switch)		
range 1:	100 to 1 000 lx	
range 2:	1 000 to 10 000 lx	
range 3:	10 000 to 100 000 lx	
Setting function	by jumper J3	
Level of light-slight:	0.1 to 1 x range	
Slight setting of light level:	potentiometer	
Time delay t:	0/1 min./2 min.	
Delay setting t:	by jumper J1	
<b>Output</b>		
Output contact:	1x NO- SPST (AgSnO <sub>2</sub> )	
Current rating:	12 A/AC1	
Switching output:	3000 VA/AC1, 384 W/DC	
Peak current:	30 A/< 3 s	
Switched voltage:	250 V AC/24 V DC	
Mechanical life:	30.000.000 ops.	
Electrical life:	100.000 ops.	
<b>Other information</b>		
Operation temperature:	-30 .. +60 °C (-22 .. 140 °F)	
Storing temperature:	-30 .. +70 °C (-22 .. 158 °F)	
Dielectric strength:	4 kV (supply-output)	
Operation position:	sensor-side down or on the sides	
Protection degree:	IP 65	
Overvoltage category:	III.	
Pollution level:	2	
Max. cable size (mm <sup>2</sup> ):	max. 1x 2.5, max. 2x 1.5/ with sleeve max. 1x 2.5 (AWG 12)	
Suggested power-supply cable:	CYKY 3x 2.5 (CYKY 4x 1.5)	
Dimensions:	98 x 62 x 34 mm (3.9" x 2.4" x 1.3")	
Weight:	117 g (4.1 oz.)	
Standards:	EN 60669-1, EN 60669-2-1	

Device is standardly supplied with jumper L-15 (3-wire connection). For the correct function of device is necessary sensor-side down device mounting.

- Is used as control of the device on the basis of ambient light intensity.
- External version in IP65, box for mounting on the wall, front cover removable without screws.
- Built in high resolution light sensor.
- Two devices in one, function is set by jumper:
  - twilight switch - contact closes by decreasing of ambient light intensity, and opens by its increasing.
  - light switch - contact closes by increasing ambient light intensity, and opens by decreasing light intensity. Used for switching of devices by reaching of pre-set ambient light level, usually sun shine (pulling down the shutters or blinds, activation of solar panels).
- 3 adjustable levels of time delay (for elimination of short-term fluctuations of light intensity - for short increases in light intensity).

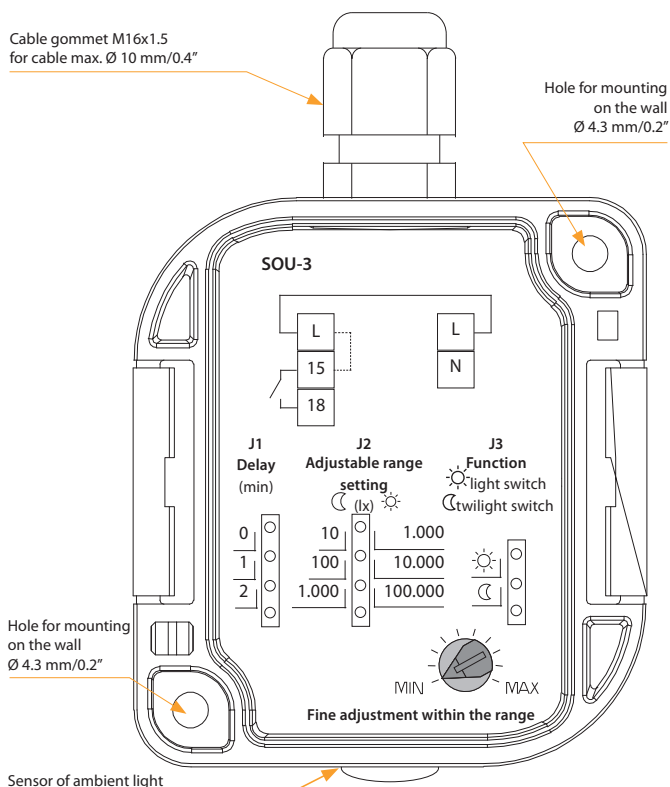
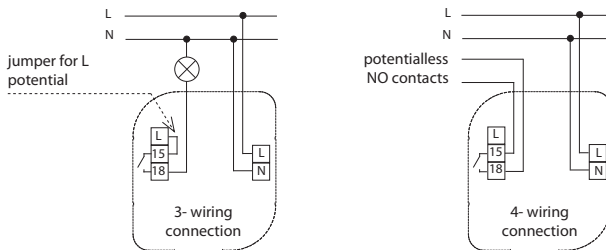
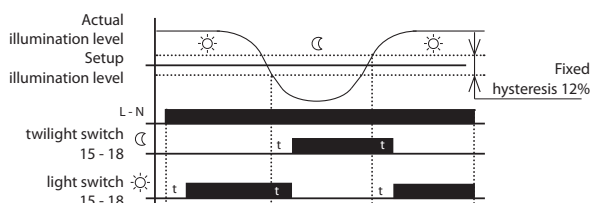
**Description**

 Cable gomet M16x1.5  
 for cable max. Ø 10 mm/0.4"

**Connection**

**Function**

Switching power supplies  
DC, unregulated

Voltage 12 V



**PSB-10-12**  
IN: AC 110-250 V  
OUT: DC 12 V stab.  
LOAD: 0.84 A/10 W  
- galvanically isolated  
- short-circuit protection/  
current overload  
- temperature protection  
MINI-BOX, into an installation box (such as KU-68)  
page 69



**PS1M-15/12V**  
Input: AC 100 - 240 V  
output: DC 12 V stab.  
load: 1.25 A/15 W.  
- short circuit protection  
- overload protection  
- overvoltage protection  
page 70



**PS2M-24/12V**  
Input: AC 100 - 240 V  
Output: DC 12 V stab.  
Load: 2 A/24 W.  
- short circuit protection  
- overload protection  
- overvoltage protection  
page 70



**PS3M-54/12V**  
Input: AC 100-240 V  
Output: DC 12 V stab.  
Load: 4.5 A/54 W.  
- short circuit protection  
- overload protection  
- overvoltage protection  
page 70



**PS4M-85/12V**  
Input: AC 100-240 V  
Output: DC 12 V stab.  
Load: 7.1 A/85 W.  
- short circuit protection  
- overload protection  
- overvoltage protection  
page 70



**PS-30-R**  
IN: AC 100-250 V  
OUT: DC 12-24 V stab.  
LOAD: 2.5-1.25A/30W  
- galvanically isolated  
- short circuit protection/  
current overload  
- temperature protection  
page 69

Voltage 24 V



**PSB-10-24**  
IN: AC 110-250 V  
OUT: DC 24 V stab.  
LOAD: 0.42A/10W  
- galvanically separated  
- electronic fuse  
- thermo protection  
MINI-BOX, into an installation box (such as KU-68).  
page 69



**PS1M-15/24V**  
Input: AC 100 - 240 V  
Input: DC 24 V stab.  
load: 0.625 A/15 W.  
- short circuit protection  
- overload protection  
- overvoltage protection  
page 70



**PS2M-30/24V**  
Input: AC 100 - 240 V  
Input: DC 24 V stable  
load: 1.25 A/30 W.  
- short circuit protection  
- overload protection  
- overvoltage protection  
page 70



**PS3M-60/24V**  
Input: AC 100-240 V  
Input: DC 24 V stab.  
load: 2.5 A/60 W.  
- short circuit protection  
- overload protection  
- overvoltage protection  
page 70



**PS4M-92/24V**  
Input: AC 100 - 240 V  
Input: DC 24 V stab.  
load: 3.83 A/92 W  
- short circuit protection  
- overload protection  
- overvoltage protection  
page 70

Switching power supply  
DC, regulated

Analog power supply  
AC+DC, unregulated



**ZNP-10-24**  
Input: AC 230 V  
Output: AC/DC 24 V unstab.  
Load: 0.4A / 10 VA  
- galvanically isolated  
- short circuit protection.  
page 72



**ZSR-30**  
IN: AC 230 V  
OUT: DC 5-24 V stab.  
OUT: AC 24 V, DC 24 V  
LOAD: 1.6-0.3A/10 VA  
- galvanically isolated  
- short circuit protection/  
current overload  
page 72

Bell transformers AC



**ZTR-8-8**  
Output voltage 8 V.  
Power: 8 VA.  
page 73



**ZTR-8-12**  
Output voltage 12 V.  
Power: 8 VA.  
page 73



**ZTR-15-12**  
Output voltage 4-8-12 V.  
Power: 4 V 5 VA;  
8 V 10 VA; 12 V 15 VA.  
page 73



Type	Design	Supply voltage	Galvanically isolated	Output				Output protection against			Description	Page	
				Analog	Switching	Stabilized DC	Output voltage	Loadability	Overcurrent	Short circuit			Temperature
ZNP-10-24	3M-DIN	AC 230 V	●	●	X	X	DC 24 V 2x AC 24 V	0.3 A	●	X	●	Fixed output voltage AC 24 V, 2x DC 24 V. Power: 8 VA (AC), 8 W (DC).	72
ZSR-30	3M-DIN	AC 230 V	●	● (REG)	X	● (REG)	DC 5-24 V DC 24 V AC 24 V	0.3 A	●	●	●	Regulated output voltage DC 5-24 V. Fixed output voltage DC 24 V, AC - 24 V. Power: 8 VA (AC), 8 W (DC).	
PSB-10-12	MINI-BOX	AC 110-250 V	X	X	●	●	DC 12 V	0.84 A	●	●	●	Fixed output voltage DC 12 V. Power: 10 W.	69
PSB-10-24	MINI-BOX	AC 110-250 V	X	X	●	●	DC 24 V	0.42 A	●	●	●	Fixed output voltage DC 24 V. Power: 10 W.	
PS-30-R	3M-DIN	AC 100-250 V	●	X	●	●	DC 12-24 V	2.5 A - 1.25 A	●	●	●	Regulated output voltage DC 12 - 24 V. Power: 30 W.	
PS1M-15/12V	1M-DIN	AC 100 - 240 V	X	X	●	●	DC 12 V	1.25 A	●	●	X	Fixed output voltage DC 12 V. Power: 15 W.	70
PS1M-15/24V	1M-DIN	AC 100 - 240 V	X	X	●	●	DC 24 V	0.625 A	●	●	X	Fixed output voltage DC 24 V. Power: 15 W.	
PS2M-24/12V	2M-DIN	AC 100 - 240 V	X	X	●	●	DC 12 V	2 A	●	●	X	Fixed output voltage DC 12 V. Power: 24 W.	
PS2M-30/24V	2M-DIN	AC 100 - 240 V	X	X	●	●	DC 24 V	1.25 A	●	●	X	Fixed output voltage DC 24 V. Power: 30 W.	
PS3M-54/12V	3M-DIN	AC 100 - 240 V	X	X	●	●	DC 12 V	4.5 A	●	●	X	Fixed output voltage DC 12 V. Power: 54 W.	
PS3M-60/24V	3M-DIN	AC 100 - 240 V	X	X	●	●	DC 24 V	2.5 A	●	●	X	Fixed output voltage DC 24 V. Power: 60 W.	
PS4M-85/12V	4M-DIN	AC 100 - 240 V	X	X	●	●	DC 12 V	7.1 A	●	●	X	Fixed output voltage DC 12V. Power: 85 W-	
PS4M-92/24V	4M-DIN	AC 100 - 240 V	X	X	●	●	DC 24 V	3.83 A	●	●	X	Fixed output voltage DC 24 V. Power: 92 W.	
ZTR-8-8	2M-DIN	AC 230 V	X	-	-	-	AC 8 V	1 A	X	■	X	Bell transformer (short-circuit-proof) for supplying of bells, door openers, home call-boxes.	
ZTR-8-12	2M-DIN	AC 230 V	X	-	-	-	AC 12 V	0.66 A	X	■	X		
ZTR-15-12	3M-DIN	AC 230 V	X	-	-	-	AC 4-8-12 V	2-1.5-1A	X	■	X		

■ protection against short circuit in primary winding

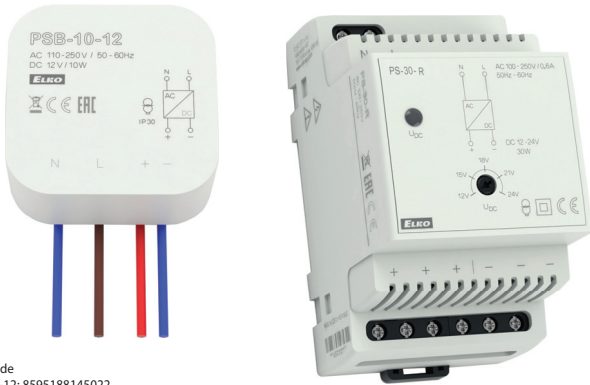

EAN code  
 PSB-10-12: 8595188145022  
 PSB-10-24: 8595188143783  
 PS-30-R: 8595188136655

- **PSB-10:** switched stabilized power supplies with fixed output voltage, designed for mounting in the installation box.
  - **PSB-10-12:** stabilized power supply 12 V/10 W.
  - **PSB-10-24:** stabilized power supply 24 V/10 W.
- **PS-30-R:** switching stabilized adjustable power supply 12-24 V/30 W.
- The output current is limited by an electronic fuse, when the maximum current is exceeded, the source switches off and switches on again after a short time delay.
- Thermal protection - in case of thermal overload the source switches off, after cooling it switches on again

Technical parameters	PSB-10-12	PSB-10-24	PS-30-R
<b>Input</b>			
Voltage range:	AC 110 - 250 V (50-60 Hz)	AC 100 - 250 V (50-60 Hz)	AC 100 - 250 V (50-60 Hz)
Burden without load (max.):	3 VA/0.5 W	10 VA/1.7 W	10 VA/1.7 W
Burden with full load (max.):	26 VA/13 W	70 VA/37 W	70 VA/37 W
Protection:	x		fuse T2A
<b>Output</b>			
Output voltage DC/max. current:	12 V/ 0.84 A	24 V/ 0.42 A	12.2 V/2.5 A 24.2 V/1.25 A
Tolerance of output voltage:	± 2%		± 3%
Output indication:	x		green LED
Wave of off-load output voltage:	40 mV		40 mV
Wave of output voltage with max load:	380 mV		500 mV
Time delay after connection:	max. 1s		max. 1s
Time delay after over-load:	max. 1s		max. 1s
Efficiency:	> 75%		> 81%
Electronic fuse:	against short circuit, current and temperature overload (from 120% of rated power)		
<b>Other information</b>			
Working humidity:	+20 .. +90 % RH		
Operating temperature:	-20 .. +40 °C (-4 .. 104 °F)		
Storage temperature:	-40 .. +85 °C (-40 .. 185 °F)		-25 .. +70 °C (-13 .. 158 °F)
Dielectric strength input- output:	4kV		
Protection degree:	IP30		IP40 front panel I/IP20 terminals
Overvoltage category:	II.		
Degree of pollution:	2		
Cross section of connecting wires (mm²):	x		max. 1x 2.5, max. 2x 1.5/s dut.max. 1x 1.5
Outlets (cross section/length):	wire CY, 4x 0.75mm², 90mm (3.5")		x
Dimensions:	49 x 49 x 21 mm (1.9" x 1.9" x 0.83")		90 x 52 x 65 mm (3.5" x 2" x 2.6")
Weight:	78 g (2.8 oz.)	78 g (2.8 oz.)	163 g (5.7 oz.)
Standard:	EN 61204-1, EN 61204-3, EN 61204-7		

Device description

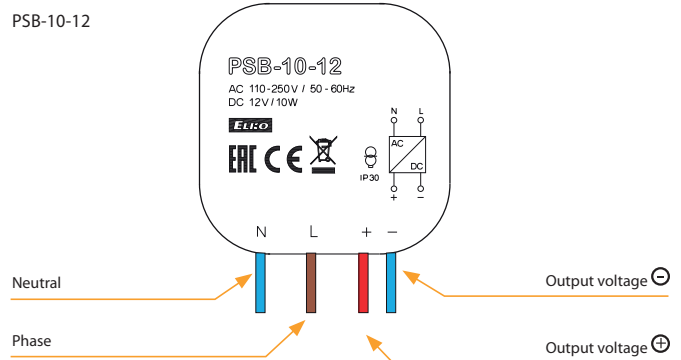

PSB-10-12/PSB-10-24 designated for installation into an installation box. Suitable for controlling of lighting sources, thermo valves, shutter engines, etc.

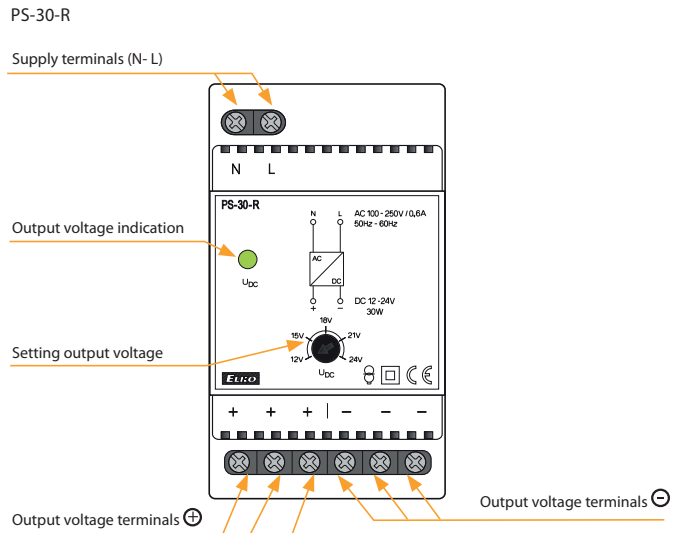

Connection

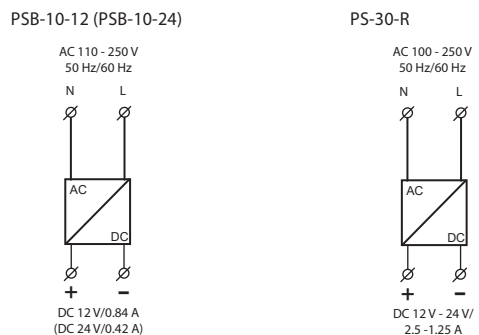



- Rated output voltage 12 or 24V DC with the possibility of regulation.
- High efficiency of up to 90%.
- Low ripple & noise.
- Protection: Over load , Over voltage and Short circuit.
- Continuously adjustable output voltage to adapt to the specific application, e.g. the need to compensate for the voltage drop caused by the length of the line.

EAN code  
 PS1M-15/12V: 8595188180474  
 PS1M-15/24V: 8595188180481  
 PS2M-24/12V: 8595188180498  
 PS2M-30/24V: 8595188180504  
 PS3M-54/12V: 8595188180511  
 PS3M-60/24V: 8595188180528  
 PS4M-85/12V: 8595188180535  
 PS4M-92/24V: 8595188180542

Technical parameters	PS1M-15/12V	PS1M-15/24V	PS2M-24/12V	PS2M-30/24V	PS3M-54/12V	PS3M-60/24V	PS4M-85/12V	PS4M-92/24V
----------------------	-------------	-------------	-------------	-------------	-------------	-------------	-------------	-------------

Input								
Voltage range:	AC 100 - 240 V (50/60 Hz)							
Tolerance:	± 10%							
Efficiency:	85%	86%	88%	89%	88%	90%	88%	90%
Burden without load (max.):	0.3W/4VA	0.5W/4VA	0.3W/8VA	0.4W/8VA	0.3W/7VA	0.5W/6.5VA	0.4W/11VA	0.1W/12VA
Burden with full load (max.):	16W/30VA	17.5W/32VA	30W/50VA	33W/60VA	60W/95VA	70W/111VA	95W/150VA	105W/160VA
Inrush current:*	max. 25A at 115V AC/60Hz max. 45A at 240V AC/50Hz				max. 30A at 115V AC/60Hz max. 60A at 240V AC/50Hz		max. 35A at 115V AC/60Hz max. 70A at 240V AC/50Hz	

Output								
Rated voltage:	12V DC	24V DC	12V DC	24V DC	12V DC	24V DC	12V DC	24V DC
Vol. setting range:	11 - 13V	23 - 25V	11 - 13V	23 - 25V	11.4 - 12.6V	22.8 - 25.2V	11 - 13V	23 - 25V
Rated current:	1.25A	0.625A	2A	1.25A	4.5A	2.5A	7.1A	3.83A
Rated power:	15W	15W	24W	30W	54W	60W	85.2W	92W
Ripple & Noise:	120mV	150mV	120mV	150mV	120mV	150mV	120mV	150mV
Output indication:	blue LED		blue LED		green LED		blue LED	
Tolerance of output voltage:	5 %							
Overload protection:	from 130 % - 200% rated output power							
Overvoltage protection:	from 110 % - 145% rated output power							
Overcurrent protection:	from 110 % - 180% rated output power							
Short circuit protection:	temporarily disconnecting the output							

Other information								
Operating temperature:	-20 .. +50°C (-4 .. 122 °F)							
Operating humidity:	20% ~ 90% RH non-condensing							
Storage temperature:	-40 .. +80°C (-40 .. 176 °F)							
Dielectric strength:	3kV AC							
Isolation resistance:	100M Ω/500V DC/25°C (77°F)/70% RH							
Overvoltage category:	III.							
Pollution degree:	2							
Max. cable size:	max. 1x 2.5 mm <sup>2</sup> , max. 2x 1.5 mm <sup>2</sup> solid wire/with sleeve max. 1x 2,5 mm <sup>2</sup>							
Terminal torque:								
input terminals	0.5 Nm		0.3 Nm		0.3 Nm		0.3 Nm	
output terminals	0.5 Nm							
Protection degree:	IP20							
MTBF:	200 000 hours minimum, full load at 25°C ambient temperature							
Mounting:	DIN rail EN 60715							
Dimensions:	90 x 18 x 58 mm (3.5" x 0.71" x 2.3")		90 x 35 x 58 mm (3.5" x 1.4" x 2.3")		90 x 52.5 x 58 mm (3.5" x 2.1" x 2.3")		90 x 70 x 58 mm (3.5" x 2.8" x 2.3")	
Weight:	78 g (2.8 oz.)		120 g (4.2 oz.)		190 g (6.7 oz.)		270 g (9.5 oz.)	
Standards:	IEC60950-1, UL508, TUV EN61558-2-16							

\* the stated values are valid for the full load from the source

Description

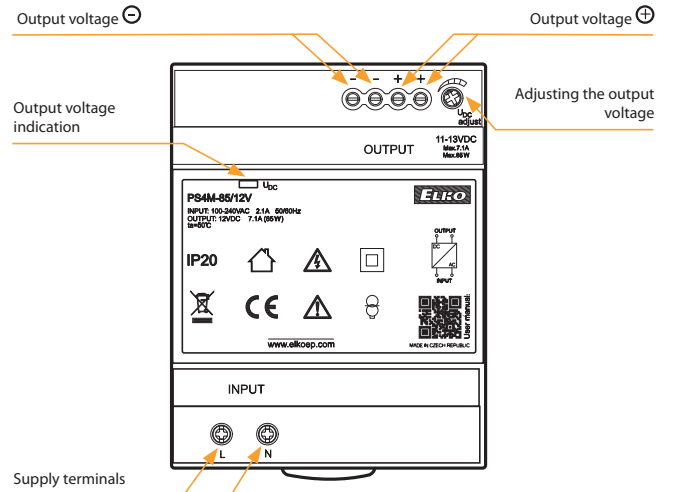
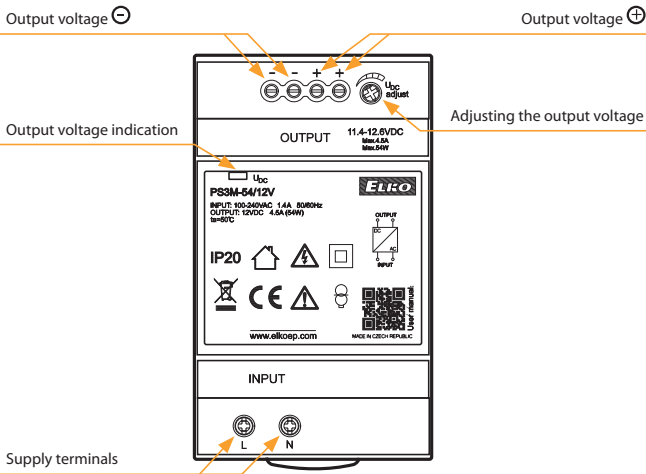
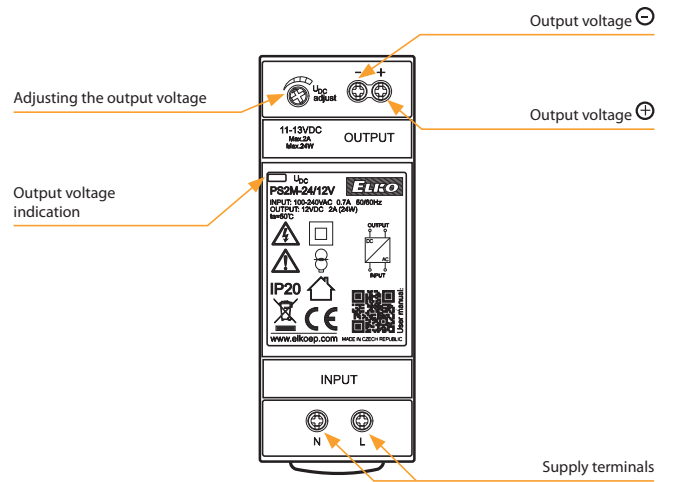
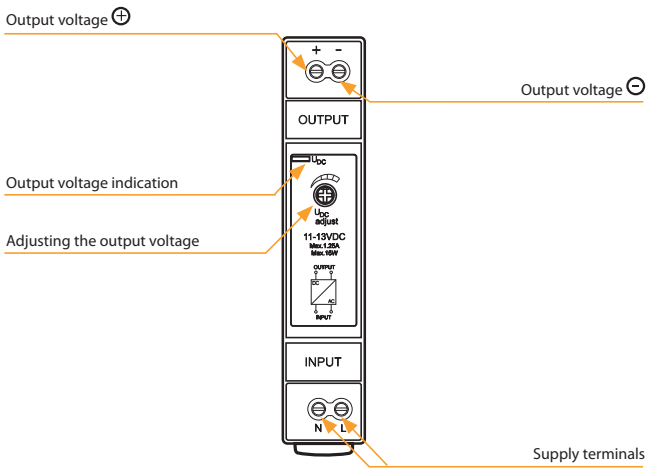

Connection

PS1M-15/12V  
(PS1M-15/24V)

DC 12V/1.25 A  
(DC 24V/0.625 A)

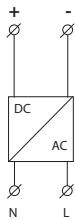

AC 100 - 240 V  
50 Hz/60 Hz

PS2M-24/12V  
(PS2M-30/24V)

DC 12V/2 A  
(DC 24V/1.25 A)

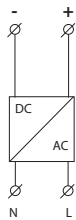

AC 100 - 240 V  
50 Hz/60 Hz

PS3M-54/12V  
(PS3M-60/24V)

DC 12V/4.5 A  
(DC 24V/2.5 A)

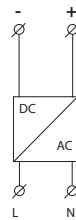

AC 100 - 240 V  
50 Hz/60 Hz

PS4M-85/12V  
(PS4M-92/24V)

DC 12V/7.1 A  
(DC 24V/3.83 A)

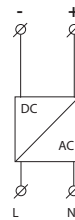

AC 100 - 240 V  
50 Hz/60 Hz

NEW



EAN code  
ZNP-10-24V: 8594030334089  
ZSR-30: 8594030331750

### Technical parameters

	ZSR-30	ZNP-10-24V
<b>Supply (<math>U_{PRI}</math>)</b>		
Supply voltage:	AC 230 V (50-60 Hz)	
Consumption – unloaded (max.):	8 VA/2.6 W	9 VA/2 W
Consumption – loaded (max.):	16 VA/13 W	
Protection:	dissolving fuse, T100 mA	
Supply voltage tolerance:	-15 %; +10 %	
<b>Output (<math>U_{SEC}</math>   <math>U_{DC}</math>   <math>U_{REG}</math>)</b>		
Output voltage:	DC 5-24 V stab. DC 24 V unstab. AC 24 V	DC 24 V unstab. AC 24 V
Voltage – unloaded AC (max.):	32 V	
Voltage – unloaded DC (max.):	43 V	
Output voltage ripple (max.):	300 mV	3 V
Efficiency:	75 %	x
Output voltage tolerance:	±5 %	x
Electronic fuse:	against short circuit & current overload	x

### Other information

Operating temperature:	-20 .. +40 °C (-4 .. 104 °F)	
Storage temperature:	-20 .. +60 °C (-4 .. 140 °F)	
Dielectric strength:	4 kV AC (supply – output)	
Protection degree:	IP40 front panel / IP20 terminals	
Cross-wire section – solid/ stranded with ferrule (mm <sup>2</sup> ):	max. 1 × 2.5, 2 × 1.5/ max. 1 × 2.5 (AWG 14)	
Dimensions:	90 × 52 × 65 mm (3.5" × 2" × 2.6")	
Weight:	402 g (14.2 oz)	368 g (13 oz)
Standards:	EN 61204-1, EN 61204-3, EN 61204-7	

### ! WARNING !

Loadability of the ZSR-30 power supply differs for different values of the supply voltage, see graph of loadability  $U_{REG}$ .

Supply of various devices and appliances by safe voltage with full galvanic isolation from the main.

### Analog power supply (regulated) ZSR-30

- Output voltage:  
DC 5-24 V, stabilized  
DC 24 V, unregulated  
AC 24 V
- In case of a complete short circuit, the output current is limited by an electronic fuse.

### Analog power supply (unregulated) ZNP-10-24V

- Output voltage:  
DC 24 V, unregulated  
AC 24 V

Protection against short circuit and overload by a dissolving fuse.

### Description

ZSR-30

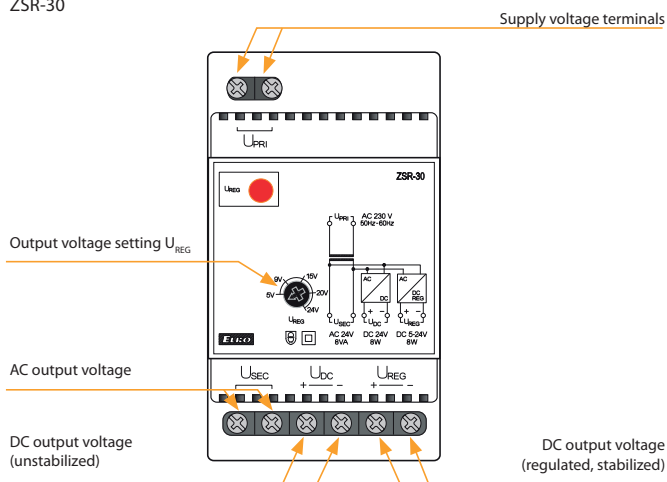

ZNP-10-24V

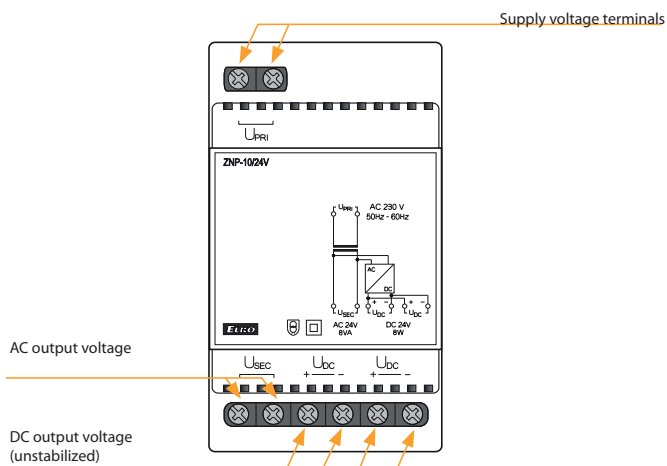

### Connection

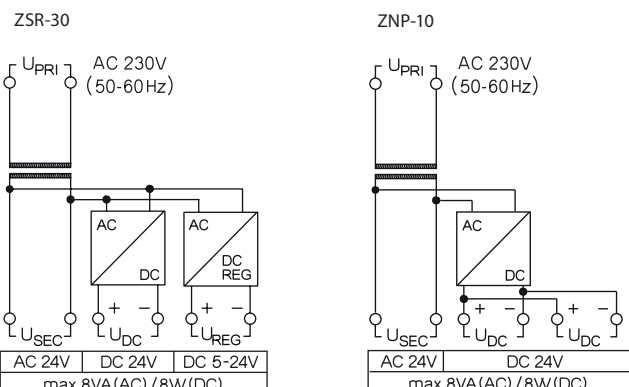

### Loadability $U_{REG}$

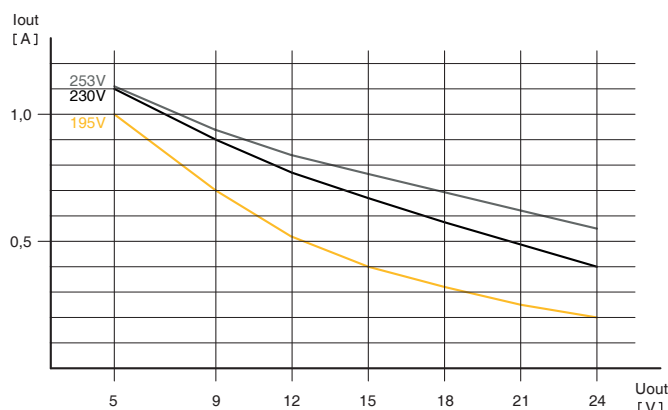

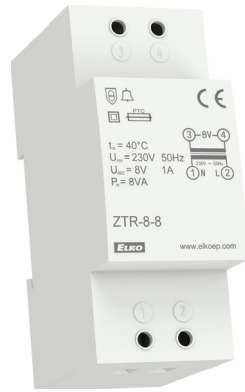

EAN code  
 ZTR-8-8V: 8595188136808  
 ZTR-8-12V: 8595188136815  
 ZTR-15-12V: 8595188139281

Technical parameters	ZTR-8-8	ZTR-8-12	ZTR-15-12
<b>Entry (U prim)</b>			
Voltage range:	AC 230 V (50 Hz)		
Max. dissipated power (Un + terminals):	1.5 W	1.5 W	2 W
Supply voltage tolerance:	± 10 %		
Efficiency:	70 %		
<b>Output (Usec)</b>			
Output voltage:	AC 8 V	AC 12 V	AC 4 V AC 8 V AC 12 V
Output voltage-no load AC:	12 V	16 V	16 V
Max.loability:	8 VA	8 VA	4 V 5 VA, 8 V 10 VA, 12 V 15 VA
Fuse (in primary winding):	short circuit protection		
<b>Other information</b>			
Operating temperature:	-20 .. +40°C (-4 .. 104 °F)		
Storing temperature:	-20 .. +60°C (-4 .. 140 °F)		
Dielectric strenght (prim/sec):	4 kV		
Protection degree:	IP40 from front panel/IP20 terminals		
Max. cable size (mm²):	solid wire max. 1x 2.5 or 2x 1.5/ with sleeve max. 1x 1.5 (AWG 12)		
Dimensions:	90 x 35.6 x 64 mm (3.5" x 1.4" x 2.6")	90 x 52 x 65 mm (3.5" x 2" x 2.6")	
Weight:	337 g (11.9 oz.)	345 g (12.2 oz.)	624 g (22 oz.)
Standards:	EN 61558-1, EN 61558-2-8		

- Designated for general use – e.g. for home bells supply, door locks supply.
- Universal power supply with AC input voltage.
- Short-circuit-proof, doubled output terminals.

- 2-MODULE, DIN rail mounting.  
**ZTR-8-8:** output voltage 8 V.  
**ZTR-8-12:** output voltage 12 V.

- 3-MODULE, DIN rail mounting.  
**ZTR-15-12:** output voltage 4, 8,12V.

Connection

ZTR-8-8

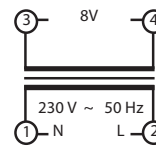

ZTR-8-12

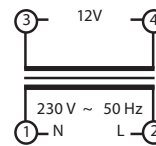

ZTR-15-12

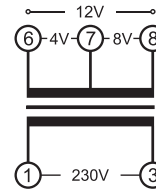



R, L, C, ESL, LED<sup>2</sup>

DIM-15

Designated for dimming of:  
dimmable energy saving  
fluorescent lamps,  
LED lamps.

R, L, C, - resistive, inductive  
and capacitive loads.  
page 76



SMR-M

For mounting under  
a wall-switch into an  
installation box KU68  
(or similar). Dimmable  
energy saving fluorescent  
lamps, LED lamps.

R, L, C, - resistive,  
inductive and capacitive  
loads.  
page 76

R, L, LED<sup>1</sup>

DIM-2

Staircase switch with  
gradual dimming up/  
down, level and time of  
illumination, all values are  
adjustable.

R = 10 -500 VA  
L = 10 -250 VA.  
page 78



SMR-S

As DIM-5, but for mount-  
ing under a wall-switch  
into an installation box  
KU68 (or the similar),  
3-wire connection  
(without neutral).

R = 10-300 VA  
L = 10-150 VA.  
page 79

R, L, C, LED<sup>2</sup>

DIM-6

Power dimming to 2kW.  
Can be controlled  
by button, external  
potentiometer, 0-10 V  
(1-10 V) system iNELS.

R = 2000 VA  
L = 2000 VA  
C = 2000 VA.  
page 80



DIM6-3M-P

DIM6-3M-P is a power  
module expansion  
unit for DIM-6. It cannot be  
operated independently.

R = 1000 VA  
L = 1000 VA  
C = 1000 VA.  
page 81

R, L, C, ESL, LED<sup>2</sup>

RFDEL-76M

Universal six-channel dimmer with  
a load capacity of up to 150 VA/  
channel (230 V version) The dimmer  
channels can be connected  
in parallel and thus increase the  
possible load up to a maximum  
of 900 VA. Each channel has a  
separate, galvanically isolated  
control input.  
page 83

R, L, C, ESL, LED<sup>2</sup>

LIC-1

Light intensity controller  
for maintaining the  
constant illumination  
level. Dimmable energy  
saving fluorescent lamps,  
LED lamps.

R, L, C, - resistive,  
inductive and capacitive  
loads.  
page 82

Accessories for LIC-1



SKS-100

Photosensor suitable for  
mounting on the wall or  
in panel.







Protection degree: IP65.

EAN code:  
8595188180733

Type	Design	Supply voltage	Type of dimmed load						Output			Method of phase regulation			Description	Page	
			R <small>resistive (el. bulbs, halogen lights)</small>	L <small>inductive (wound transformers)</small>	C <small>capacitive (electronic transformers)</small>	ESL	LED <sup>1</sup>	LED <sup>2</sup>	Output element	Rated load			Rising edge	Falling edge			Control method 0-10 V/1-10V
										R	L	C					
DIM-15	1M-DIN	AC 230 V	●	●	●	●	x	●	2x MOSFET	300 VA	300 VA	300 VA	●	●	x	Universal dimmer R, C, L, ESL, LED <sup>2</sup> , button control.	76
SMR-M	BOX	AC 230 V	●	●	●	●	x	●	2x MOSFET	160 VA	160 VA	160 VA	●	●	x	Like DIM-15, but for mounting under the push-button into the installation box (e.g. KU68).	
DIM-2	1M-DIN	AC 230 V	●	●	x	x	●	x	triak	10-500 VA*	10-250 VA	x	●	x	x	Stairway automaton with progressive illumination on/off, adjustable rise time, delay, maximum brightness. Dimmer R, L, LED <sup>1</sup> .	78
DIM-6	6M-DIN	AC 230 V	●	●	●	x	x	●	4x MOSFET	2 000 VA*	2 000 VA*	2 000 VA*	●	●	●	Universal dimmer 2kW R, C, L, LED <sup>2</sup> , power expandable, pushbutton control/0-10 V/1-10 V/ potentiometer/INELS 2 bus.	80
DIM6-3M-P	3M-DIN	AC 230 V	●	●	●	x	x	●	2x MOSFET	1 000 VA*	1 000 VA*	1 000 VA*	●	●	x	Expansion power module 1kW to DIM-6 dimmer.	81
SMR-S	MINI-BOX	AC 230 V	●	●	x	x	●	x	triak	10-300 VA*	10-150 VA	x	●	x	x	Designed for dimming bulbs, halogen lamps with wound transformer, dimmable LED <sup>1</sup> into the installation box (e.g. KU68).	79
LIC-1	1M-DIN	AC 230 V	●	●	●	●	x	●	2x MOSFET	300 VA*	300 VA*	300 VA*	●	●	x	Universal dimmer R, C, L, ESL, LED <sup>2</sup> , button control, constant light level control.	82
RFDEL-76M	6M-DIN	AC 230/ -120 V	●	●	●	●	x	●	12x MOSFET	6x 150 VA (230 V)	6x 150 VA (230 V)	6x 150 VA (230 V)	●	●	x	Load capacity 150 VA/channel (230 V version) or possibility to connect up to max. 900 VA in parallel at the expense of the number of channels. Each channel has a separate, galvanically separated input.	83

\* with load over 300 VA is necessary to ensure sufficient cooling

**Explanation of symbols**

TYPE OF LOAD (symbols)	bulbs, halogen lamps	low-voltage el.bulbs 12/24V wound transformers	low-voltage el.bulbs 12/24V electronic transformers	ESL dimmable compact fluorescent lamps	Dimmable LED bulbs (triac dimmer)	Dimmable LED bulbs (dimmer with MOSFET)
	 R	 L	 C	 ESL	 LED <sup>1</sup>	 LED <sup>2</sup>

Demonstrated symbols are informative

**Explanation:**



Dimmer with designated load:

R - resistive

L - inductive

C - capacitive

ESL - energy saving bulbs

LED<sup>1</sup> - dimmable LED bulbs, designed for dimmers with phase-controlled rising edge (triac dimmers)

LED<sup>2</sup> - dimmable LED bulbs designed for dimmers with phase or phase-to-phase phase control (dimmers with MOSFET).

IPxx protection - under normal conditions: normal conditions are understood as such conditions of operating an electrical device, installation and power supply network for which the entire device is designed, produced and installed. Upon these normal conditions of use and upon normal maintenance, all protective devices must be effective throughout the entire expected service life of the product.

Recommendation for mounting modular dimmers: leave a gap of min. 0.5 module (approx. 9 mm / 0.4") on side of the device to ensure better cooling of the device.



EAN code  
DIM-15/230 V: 8595188140690  
SMR-M: 8595188143776

Technical parameters	DIM-15	SMR-M
Supply terminals:	A1 - A2	x
Voltage range:	x	4-wire, with neutral
Operating range:	AC 230 V (50 Hz)	
Burden (unloaded):	max. 2 VA/0.55 W	max. 0.66 VA/0.55 W
Max. dissipated power:	2 W	3 W
Supply voltage tolerance:	-15 %; +10 %	
Supply indication:	green LED	
<b>Control</b>		
Control terminals:	A1 - T	x
Control wire:	x	L - S
Control voltage:	AC 230 V	
Control input power:	AC 0.3 - 0.6 VA	
Control impulse length:	min. 80 ms/max. unlimited	
Glow tubes connection:	Yes	
Max. amount of glow lamps connected to controlling input:	max. 15 pcs (measured with glow lamp 0.68 mA/ 230 V AC)	max. 10 pcs (measured with glow lamp 0.68 mA/ 230 V AC)
<b>Output</b>		
Contactless:	2 x MOSFET	
Load:	300 W (at $\cos \varphi = 1$ )*	160 W (at $\cos \varphi = 1$ )*
Output status indication:	red LED	x
<b>Other information</b>		
Operating temperature:	-20 .. +35 °C (-4 .. 95 °F)	
Storing temperature:	-20 .. +60 °C (-4 .. 140 °F)	
Operating position:	any	
Mounting:	DIN rail EN 60715	free at connecting wires
Protection degree:	IP40 from front panel/ IP10 clips	IP30 in standard conditions**
Overvoltage category:	III.	
Pollution level:	2	
Terminal wire capacity (mm <sup>2</sup> ):	max. 2x2.5, max. 1x 4 with sleeve max. 1x2.5, max. 2x1.5 (AWG 12)	x
Connection wires (cross-section/length):	x	CY, 0.75 mm <sup>2</sup> (AWG 18)/ 90 mm (3.5")
Dimensions:	90 x 17.6 x 64 mm (3.5" x 0.69" x 2.5")	49 x 49 x 21 mm (1.9" x 1.9" x 0.83")
Weight:	58 g (2 oz.)	33 g (1.2 oz.)
Standards:	EN 60669-1, EN 60669-2-1	

\* Due to a large number of light source types, the maximum load depends on the internal construction of dimmable light sources and their power factor  $\cos \varphi$ . The power factor of dimmable LEDs and ESL bulbs ranges from  $\cos \varphi = 0.95$  to 0.4. An approximate value of maximum load may be obtained by multiplying the load capacity of the dimmer by the power factor of the connected light source.

\*\* For more information see page 75.

**Warning:** it is not allowed to connect inductive and capacitive loads at the same time.

- Designed for dimming of incandescent bulbs and halogen lights with wound or electronic transformer, dimmable light bulbs and dimmable LED<sup>2</sup>.
- Enables gradual setting of luminance by push-button (non-detent) or parallel buttons.
- Returns to last state upon re-energization.
- Type of light source is set by switch-over on the front panel of device.
- Min. luminance, set by potentiometer on the front panel, eliminates flashing of light sources.

LED<sup>2</sup>: more informations on page 75

## Connection

DIM-15

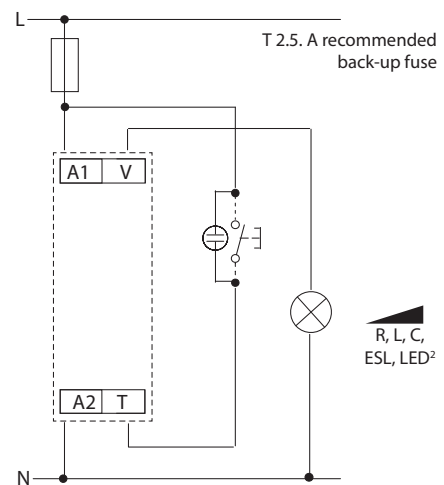

SMR-M

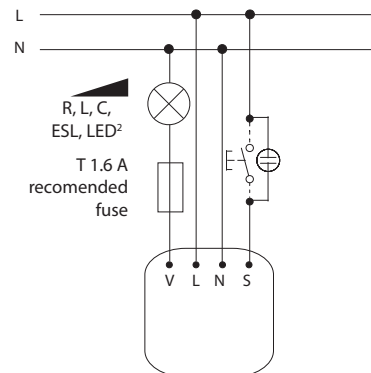

## Symbol

DIM-15  
(SMR-M)

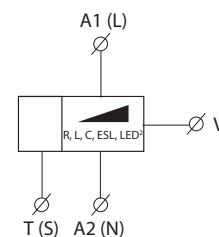

Device description

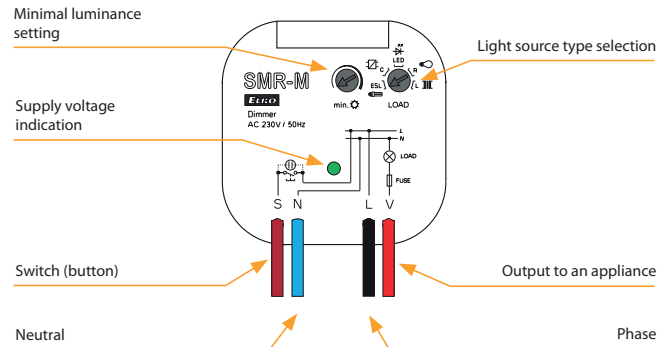
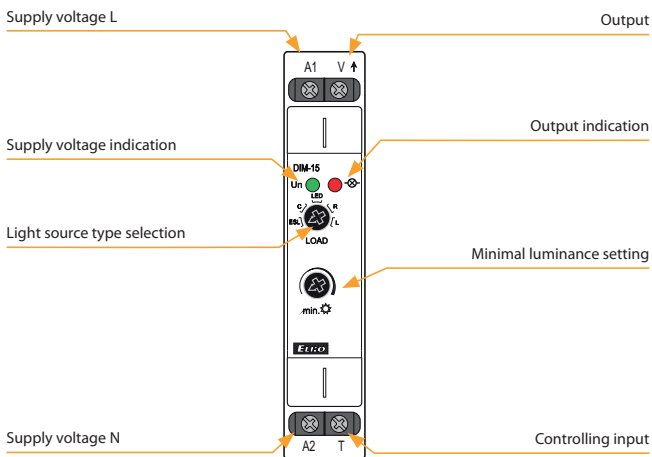

Functions and controlling

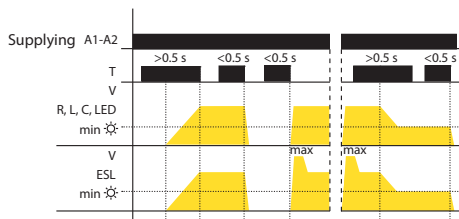

- short button press ( $<0.5$  s) turns the light off or on
  - long press ( $>0.5$  s) enables slight regulation of light intensity
  - setting of minimal luminance is possible only during decreasing of luminance by long button press
  - setting of minimal luminance by saving fluorescent lamps serves for harmonizing of lowest light intensity prior its unprompted switching off
- Luminance setting:  
LED, R, L, C:
- if the light is turned off, short press ( $<0.5$  s) switches the light onto last set luminance level
- ESL:
- when light is off, short impulse turns lamp on and then luminance is decreased to set level

Connection example

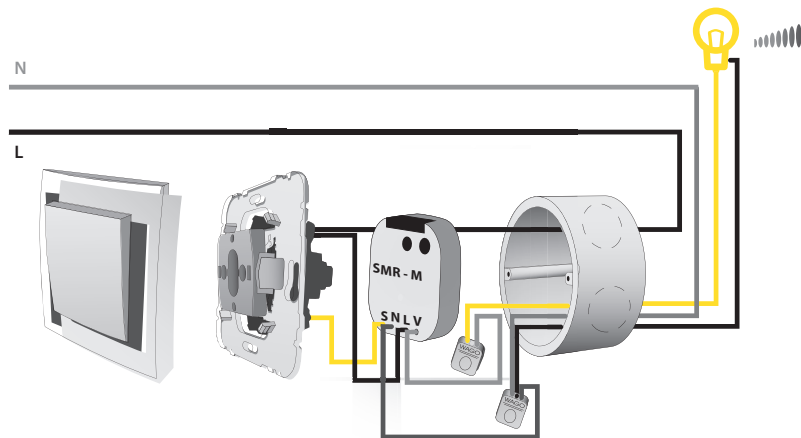

Additional information

- it is not possible to dim energy-saving lamps without marking: dimmable
- an incorrect setting of light source has effect only on dimming range, it means neither dimmer or load get damaged
- max. number of dimmable light sources depends on their internal structure
- it is not recommended to connect light sources with different types and brands, to one dimmer



EAN code  
DIM-2 /230 V: 8595188112475  
DIM-2-1h /230V: 8595188135740

Technical parameters	DIM-2
Supply terminals:	A1 - A2
Voltage range:	AC 230 V/50 Hz
Burden (unloaded):	max. 8 VA/0.6 W
Max. dissipated power:	1.5 W
Supply voltage tolerance:	-15 %; +10 %
Supply indication:	green LED
Time setting by:	potentiometers
Time deviation:	10 % - mechanical setting
Repeat accuracy:	5 % - set value stability
Temperature coefficient:	0.01 %/°C, at = 20 °C (0.01 %/°F, at = 68 °F)
Recovery time:	max. 80 ms
<b>Controlling T1 (button)</b>	
Terminals:	T1 - A1
Voltage:	AC 230 V
Power on control input:	max. 1.5 VA
Impulse length:	min.100 ms/max. unlimited
Glow-lamps:	Yes
Max. amount of glow lamps connected to controlling input:	230 V - max. amount 50 pcs (measured with glow lamp 0.68 mA/230 V AC)
<b>Controlling T2 (switch)</b>	
Terminals:	T2 - A1
Voltage:	AC 230 V
Power on control input:	0.1 VA
Impulse length:	min.100 ms/max. unlimited
<b>Output</b>	
Contactless:	1x triac
Current rating:	2 A
Resistance load:	10 - 500 VA
Inductive load:	10 - 250 VA
<b>Other information</b>	
Operating temperature:	-20 .. +55 °C (-4 .. 131 °F)
Storage temperature:	-30 .. +70 °C (-22 .. 158 °F)
Operating position:	any
Mounting:	DIN rail EN 60715
Protection degree:	IP40 from front panel/IP10 terminals
Overvoltage category:	III.
Pollution degree:	2
Max. cable size (mm <sup>2</sup> ):	solid wire max. 2x 2.5 or 1x 4/ with sleeve max. 1x 2.5 or 2x 1.5 (AWG 12)
Dimensions:	90 x 17.6 x 64 mm (3.5" x 0.7" x 2.5")
Weight:	64 g (2.3 oz.)
Standards:	EN 60669-1, EN 60669-2-1

## Symbol

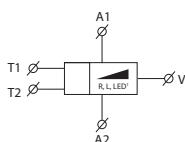

- Designated for dimming el. bulbs, halogen lights and halogen lights with winding transformers and Dimmable LED<sup>1</sup>.
- Intelligent control of halogen lights, function of gradual switching on and dimming.
- Controlling inputs for push button and switch.
- Values are set on front panel of the product, adjustable:
  - maximum dim-up
  - speed (fluency) of dim-up
  - speed (fluency) of dim-down
  - time for which a light is on with maximum dim-up.
- Output without contact: 1x triac.
- Parallel connection of controlling pushbuttons is possible.
- Protection against over-temperature inside the product - switches out-put off + signalizes overheating by LED flashing.
- Note: possibility of start and finish adjustment up on 1 second to 1 hour, device has description DIM-2 1h.

LED<sup>1</sup>: more informations on page 75

## Description

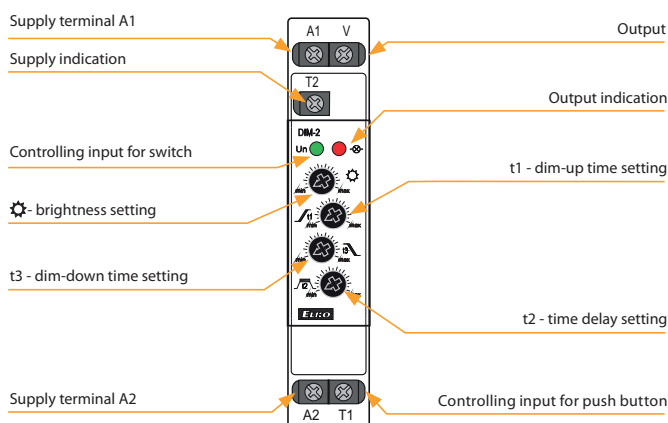

Recommendation for mounting: leave a gap of min. 0.5 module (approx. 9 mm,(0.3")) on side of the device to ensure better cooling of the device.

## Connection

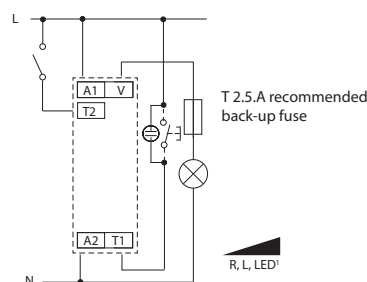

## Function

## Controlled via input T1 (button)

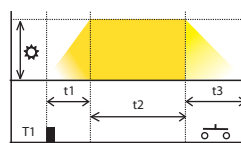

Dim-up delay-down is started by a button. Cycle extension - by re-pressing button (during the cycle).

## Controlled via input T2 (switch)

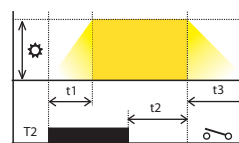

The switch starts the cycle and it stops on max.set brightness. After the switch is off, the cycle will continue until completed.

## Legend:

- ☀ Brightness: 10 - 100 %
- t1 Dim-up time: 1 - 40 s
- t2 Time delay: 0 s - 20 min
- t3 Dim-down time: 1 - 40 s

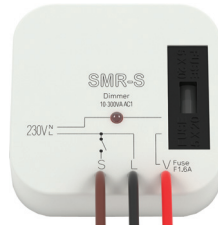

EAN code  
SMR-S/230V: 8595188123518

Technical parameters		SMR-S
Connection:	3-wire con., without neutral	
Voltage range:	230 V AC (50 Hz)	
Burden (unloaded):	max. 0.66 VA/0.55 W	
Max. dissipated power:	3 W	
Supply voltage tolerance:	-15 %; +10 %	
<b>Output</b>		
Contactless:	1x triac	
Resistive load:	10 - 300 VA	
Inductive load:	10 - 150 VA	
Capacitive load:	x	
<b>Control</b>		
Control voltage:	AC 230 V	
Current:	max. 3 mA	
Impulse lenght:	min. 50 ms/max. unlimited	
Glow tubes connection:	Yes	
Max. amount of glow lamps connected to controlling input:	230 V - max. amount 10 pcs (measured with glow lamp 0.68 mA/230 V AC)	
<b>Other information</b>		
Operating temperature:	0 .. +50 °C (32 .. 122 °F)	
Operating position:	any	
Mounting:	free at connecting wires	
Protection degree:	IP30 in standard conditions*	
Overvoltage category:	III.	
Pollution degree:	2	
Fuse:	F 1.6 A/250 V	
Connection wires:	solid wires 0.75 mm <sup>2</sup> (AWG 18)/90 mm (3.5 inch)	
Glow lamps in a button:	max. number 10	
Dimensions:	49 x 49 x 13 mm (1.9" x 1.9" x 0.5")	
Weight:	30 g (1.06 oz.)	
Standards:	EN 60669-1, EN 60669-2-1	

\* for more information see page 75

- Button-controlled dimmers designated for flush mounting into a wiring box.
- Possible to control from more places (parallel connections).
- Protection against temperature overrun inside the device.
- Designated for dimming el. bulbs, halogen lights and halogen lights with winding transformers and Dimmable LED<sup>1</sup>.
- 3-wire connection, functional without neutral.
- Max. load: 300 VA (el. bulbs or halogen lights with wound transformer).
- Contactless output -1x triac.
- With exchangeable fuse.

LED<sup>1</sup>: more informations on page 75

Description of SMR-S

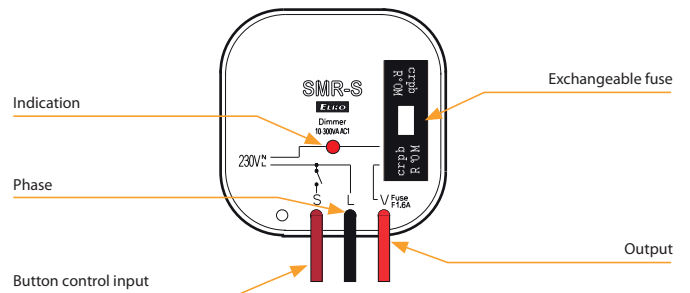

Connection

Typical connection of SMR-S - dimmer of lights

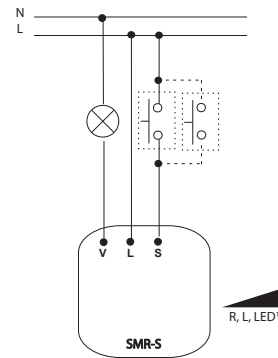

Warning: it cannot be used for fluorescent lights and energy saving lights!

Function

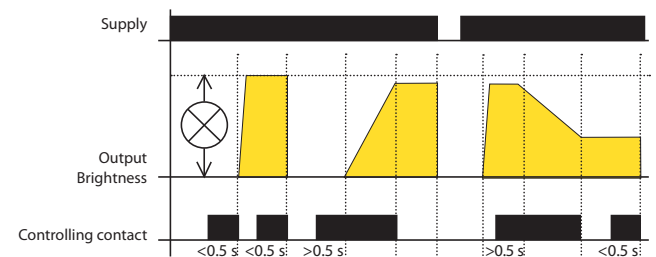

Short press (<0.5 s) turns a light on, another short press turns it off. A longer press (>0.5 s) causes a gradual regulation of light intensity min-max-min round until the button is released. After releasing a set intensity is kept in memory, further short presses turn the light on/off keeping the set intensity. The intensity can be changed by further long press. After de-energising the relay remembers the set value.



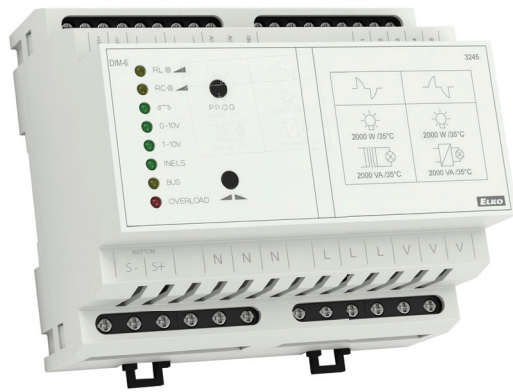

EAN code  
DIM-6 /230 V: 8595188136914

Technical parameters	DIM-6
Supply terminals:	L, N
Supply voltage:	AC 230 V (50 Hz)
Burden (unloaded):	max. 4 VA/3.2 W
Max. dissipated power:	6 W
Tolerance of voltage range:	-15 %; +10 %
Max. output power:	max. 2 000 VA
Module extendable:	to 10 000 VA
Galvanic separation of BUS and power output:	Yes
Isul. volt. between outputs and inner circuits:	3.75 kV, SELV according to EN 60950
<b>Control - button type</b>	
Control voltage:	AC/DC 12-240 V
Control terminals:	S-, S+, galvanically separated
Power of control input (max.):	0.53 VA (AC 12-240 V), 0.35W (DC 12-240V)
Length of control impulse:	min. 25ms/max. unlimited
Recovery time:	max. 150 ms
Connection of glow lamps:	No
<b>Control 0(1)-10 V</b>	
Control terminals:	0(1)-10 V, GND
Control voltage:	0-10 V or 1-10 V
Min. current of control input:	1 mA
<b>BUS control:</b>	
Control terminals:	BUS+, BUS-
BUS voltage:	27 V DC
Current of control input:	5 mA
Indication of data transmission:	yellow LED
<b>Output</b>	
Contactless:	4 x MOSFET
Current rating:	10 A
Resistive load:	2 000 VA*
Inductive load:	2 000 VA*
Capacitive load:	2 000 VA*
Indication of output state:	yellow LED, according to load type
<b>Other information</b>	
Operating temperature:	-20 .. +35 °C (-4 .. 95 °F)
Storing temperature:	-30 .. +70 °C (-22 .. 158 °F)
Operating position:	vertical
Mounting:	DIN rail EN 60715
Protection degree:	IP40 from front panel
Purpose of control device:	operative control device
Construction of control device:	individual control device
Char. of automatic operation:	1.B.E
Heat and fire resistance cat.:	FR-0
Anti-stroke category (immunity):	class2
Rated impulse voltage:	2.5 kV
Overvoltage category:	III.
Pollution level:	2
Profile of connecting wires (mm <sup>2</sup> )	
output part:	max.1x2.5, max. 2x1.5/with sleeve max. 1x1.5 (AWG 12)
control part:	max.1x2.5, max. 2x1.5/with sleeve max. 1x2.5 (AWG 12)
Dimensions:	90 x 105 x 65 mm (3.5" x 4.1" x 2.6")
Weight:	392 g (13.8 oz.)
Standards:	EN 60669-1, EN 60669-2-1

- Designed for dimming of incandescent bulbs and halogen lights with wound or electronic transformer and Dimmable LED<sup>2</sup>.
- DIM-6 control options:
  - button (parallel button connection)
  - external potentiometer
  - analog signal 0-10 V (1-10 V)
  - iNELS BUS system.
- The DIM-6 can connect up to 8 pieces of DIM6-3M-P and control up to 10.000 VA.
- Electronic overcurrent protection, overvoltage and short-circuit protection.
- Protection against over-heating inside device - switch off output + signalize overheat by flashing red LED.
- 6-MODULE version, DIN rail mounting.
  - LED<sup>2</sup>: more informations on page 75

## Description

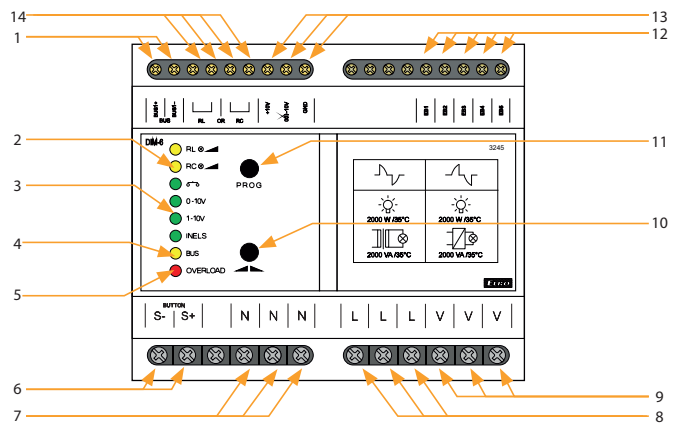

- |                                |   |   |
|--------------------------------|---|---|
| 1 Terminals for BUS connection | 6 Terminals for connecting control button | 11 Button for output control                                      |
| 2 Load type indication         | 7 Terminals of neutral wire               | 12 Terminal for additional modul conductor bar                    |
| 3 Control type indication      | 8 Terminal for phase conductor connection | 13 Terminals for control by signal 0(1)-10 V, or by potentiometer |
| 4 BUS data transfer indication | 9 Output terminals                        | 14 Terminal for regulation load of wire jumper                    |
| 5 Overload indication          | 10 Button for output control              |   |

## Types of indication LED

- RL - Yellow - indicates configuration of load RL
- RC - Yellow - indicates configuration of load RC
- Green - button control mode selected
- 0-10V - Green - 0-10 V signal control mode selected
- 1-10V - Green - 1-10 V signal control mode selected
- iNELS - Green - BUS conductor bar-iNELS control mode selected
- BUS - Yellow - indicates data transfer communication of BUS
- OVERLOAD - Red - indicates overload, flashing LED signalizes over-heating inside the device, shinning LED signalizes current overload

## Symbol

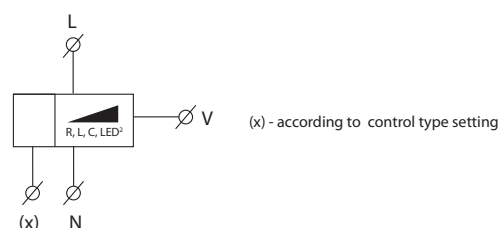

\* **Warning:** it is not allowed to connect inductive and capacitive loads at the same time.



EAN code  
DIM6-3M-P: 8595188139106

Technical parameters		DIM6-3M-P	
Load:		max. 1 000 VA	
Max. dissipated power:		6 W	
<b>Output</b>			
Contactless:		2 x MOSFET	
Current rating:		5 A	
Resistive load:		1 000 VA*	
Inductive load:		1 000 VA*	
Load capacity:		1 000 VA*	
<b>Other information</b>			
Operating temperature:		-20 .. +35 °C (-4 .. 95 °F)	
Storing temperature:		-30 .. +70 °C (-22 .. 158 °F)	
Operating position:		vertical	
Mounting:		DIN rail EN 60715	
Protection degree:		IP40 from front panel	
Controlling device purpose:		operating control device	
Controlling device construction:		additional control device	
Automatic operating char.:		1.B.E	
Heat and fire resistance category:		FR-0	
Immunity category:		class 2	
Rated impuls voltage:		2.5 kV	
Overvoltage category:		III.	
Pollution level:		2	
Profile of connecting wires (mm <sup>2</sup> )			
output part:		max.1x2.5, max. 2x1.5/with sleeve max. 1x1.5 (AWG 12)	
control part:		max.1x2.5, max. 2x1.5/with sleeve max. 1x2.5 (AWG 12)	
Size:		90 x 52 x 65 mm (3.5" x 2" x 2.6")	
Weight:		130 g (4.5 oz.)	
Standards:		EN 60669-1, EN 60669-2-1	

- Expanding power module only for use in combination with DIM-6.
- DIM6-3M-P provides power increase (of about 1 000 VA) of load connected to DIM-6 (it means: 2 000 VA (DIM-6) + 1 000 VA (DIM6-3M-P) = 3 000 VA).
- The DIM-6 can connect up to 8 pieces of DIM6-3M-P and control up to 10.000 VA (the load must be divided into individual power blocks so that their maximum power is not exceeded).
- Attention-device has to be protected by circuit breaker accordant to the load connected to device.
- DIM-6 in installation is cooled by natural air flow. If the natural air flow access is reduced, cooling has to be provided by ventilator. Rated operating temperature is 35 °C/95 °F.
- If there are several DIM6-3M-P connected to DIM-6, the distance between them has to be min. 2 cm/0.8".
- Max. length of BUS EB is 1 m/39.4" and the connection has to be realized by shielded cable.

**Device description**

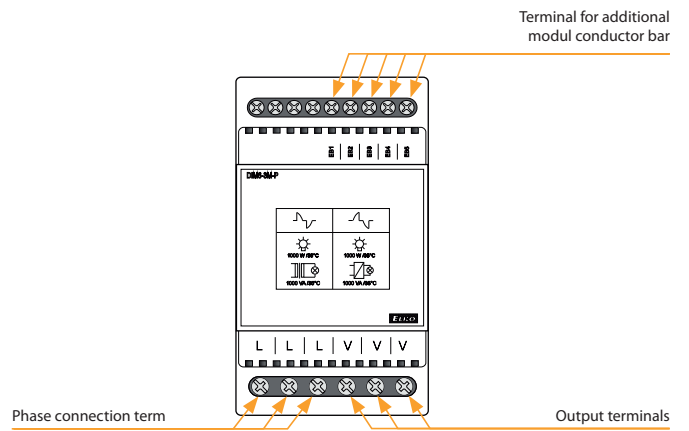

**Note**

The DIM-6 dimmer (L, V) terminals and the DIM6-3M-P expansion module are three-fold for easier multi-part loads.

\* **Warning:** it is not allowed to connect loads of inductive and capacitive character at the same time.

**Connection**

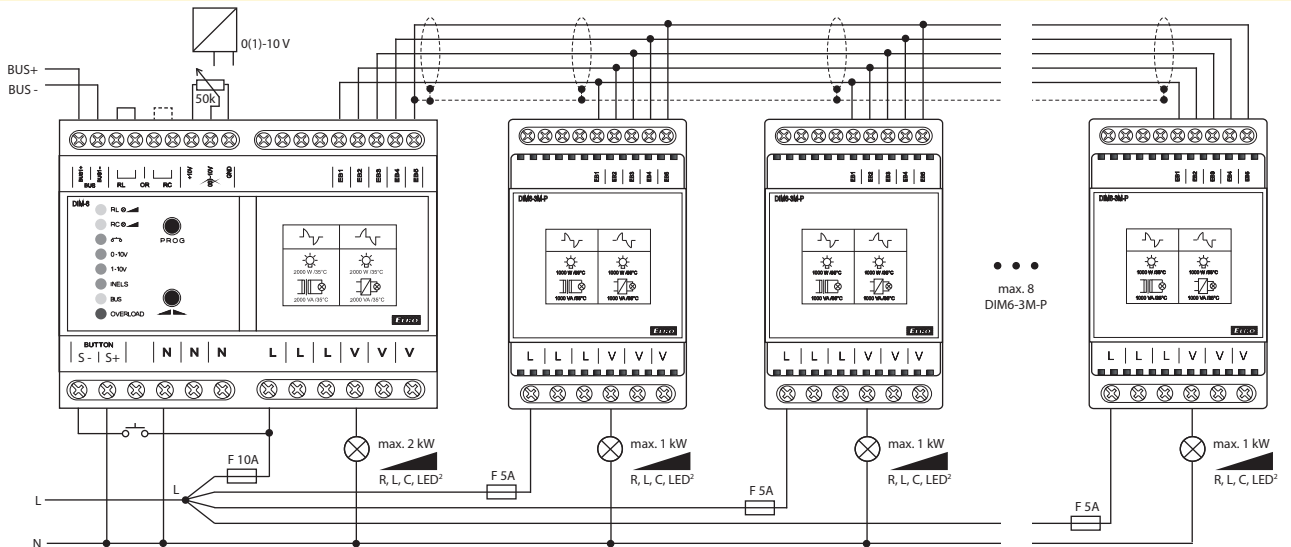

A quick fuse corresponding to the power of each module must be included in the L supply for each module.



EAN code  
LIC-1 + SKS-100: 8595188144933  
Photosensor SKS-100: 8594030337288

SKS-100

### Technical parameters

### LIC-1

Supply terminals:	A1 - A2
Supply voltage:	AC 230 V (50-60 Hz)
Burden (unloaded):	max. 1.6 VA/0.8 W
Max. dissipated power:	1 W
Supply voltage tolerance:	±15 %
Power supply indication:	green LED

### Control

Button - control. terminals:	A1 - T
Control voltage:	AC 230 V
Control input power:	max. 0.6 VA
Control impulse length:	min. 80 ms/max. unlimited
Glow tubes connection (terminals: A1 - T):	Yes
Maximum number of connected glow lamps the control input:	230 V - max. amount 50 pcs (measured with glow lamp 0.68 mA/230 V AC)
Blocking input - terminals:	A1 - B
Control. voltage:	AC 230 V
Supply:	max. 0.1 VA
Connect glow-lamps (terminals A1 - B):	No
Impulse length:	min. 80 ms/max. unlimited

### Output

Contact type:	2x MOSFET
Load capacity:*	300 VA (at $\cos \varphi = 1$ )

### Other information

Operating temperature:	-20 .. +35 °C (-4 .. 95 °F)
Storage temperature:	-20 .. +60 °C (-4 .. 140 °F)
Operating position:	any
Mounting:	DIN rail EN 60715
Ingress protection:	IP40 from front panel/IP10 terminals
Overvoltage category:	III.
Contamination degree:	2
Connecting conductor cross-section (mm <sup>2</sup> ):	solid wire max. 2x 2.5 or 1x 4 with sleeve max. 1x 2.5 or 2x 1.5 (AWG 12)
Dimensions:	90 x 17.6 x 64 mm (3.5" x 0.7" x 2.5")
Weight:	66 g (2.33 oz.)
Standards:	EN 60669-1, EN 60669-2-1

\* Due to a large number of light source types, the maximum load depends on the internal construction of dimmable LEDs and ESL bulbs and their power factor  $\cos \varphi$ . The power factor of dimmable LEDs and ESL bulbs ranges from  $\cos \varphi = 0.95$  to 0.4. An approximate value of maximum load may be obtained by multiplying the load capacity of the dimmer by the power factor of the connected light source.

**Warning:** it is not allowed to connect inductive and capacitive loads at the same time.

- Designed for dimming of incandescent bulbs and halogen lights with wound or electronic transformer, dimmable light bulbs and dimmable LED<sup>2</sup>.
- Automatically regulates the intensity of light in a room.
- External sensor scans the intensity and based on the preset value it decreases or increases the brightness of light.
- Operating status:
  - 1 - Off
  - 2 - Automatic regulation
  - 3 - Cleaning (maximum level of illumination)
  - 4 - Setting the minimum lighting brightness
  - 5 - Setting the desired level of illumination.
- Optional connection of buttons with 50 neon lamps.

LED<sup>2</sup>: more information, see page 75

### Description

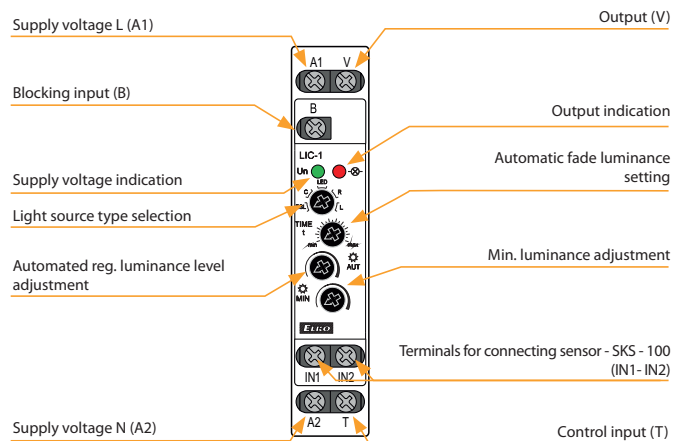

### Connection

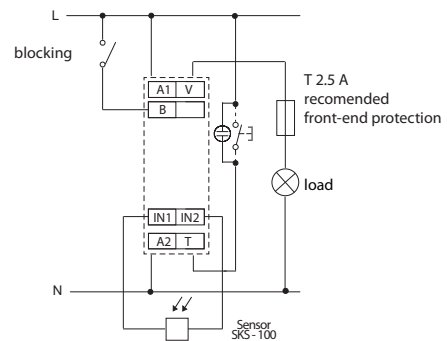

### Function

#### T-button control:

- pressing button shortly (< 0.5 s) always turns of lamp
- pressing button longer (0.5 to 3 s) turns on lamp in automatic regulation mode
- pressing button long (> 3 s) turns on lamp to full illumination - „cleaner“ mode
- after turning on the power supply, the dimmer is always turned off.

#### Thyristor B:

serves to block automatic regulation (lamp turns off).  
**WARNING!** The lamp may be turned on in “cleaner” mode even while blocked.  
After ending block mode, the lamp remains off.

### Symbol

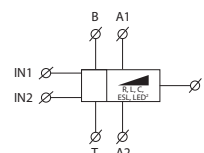

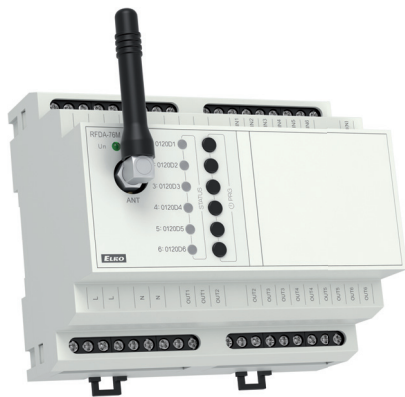

EAN code  
RFDEL-76M / 230: 8595188182058  
RFDEL-76M / 120: 8595188182096

- RFDEL-76M is a universal 6-channel actuator, which is used to control the brightness intensity of dimmable sources R - L - C - LED - ESL.
- The maximum possible load is 150 VA for 230 V and 75 VA for 120 V for each channel.
- The individual channels of the dimmer can be connected in parallel and thus increase the maximum output load at the expense of the number of outputs.
- Each of the output channels is individually controllable and addressable.
- By setting the min. brightness eliminates flickering of different types of light sources, setting min. brightness and type of load is done using the PROG buttons.
- Electronic overcurrent, thermal and short-circuit protection, which switches off the output.
- 6 galvanically isolated inputs for wired buttons, which can be used to control the outputs independently of the RF.
- Communication with bidirectional RFIO2 protocol. The package includes an internal AN-I antenna, in case of placement of a sheet metal distribution element, you can use an external AN-E antenna to improve the signal.

**Technical parameters** RFDEL-76M/230V RFDEL-76M/120V

Supply voltage:	230 V AC	120 V AC
Supply voltage frequency:	50 Hz	60 Hz
Power supply indication:	green LED Un	
Supply voltage tolerance:	+10/ -15 %	

**Output**

Output:	12x MOSFET transistor	
Load type:*	R - resistive, L - inductive, C - capacitive, ESL - economical, LED	
Minimum output power:	10 VA	
Max. output power / channel:	150 VA	75 VA
Possible to connect outputs:	yes	
Maximum power when connecting all outputs:	max. 900 VA	max. 450 VA
Output protection:	thermal/short-term overload/longterm overload/short circuit	
Output indication:	red LED STATUS	

**Control**

Wired buttons:	potential "L" or external voltage AC 20-230 V (50-60Hz)/DC 20-230 V
Wireless:	up to 32 channels (with iNELS RF buttons)
Communication protocol:	RFIO2
Function repeater:	yes
Range:	in the open up to 160 m (524.11 ft)
RF antenna:	AN-I included (SMA connector)

**Other information**

Operating temperature:	-20 .. + 50 °C (-4 .. 122 °F)
Storage temperature:	-30 .. +70 °C (-22 .. 158 °F)
Ingress protection:	IP20 under normal conditions
Overvoltage category:	II.
Contamination degree:	2
Connecting conductor:	max. 2.5mm <sup>2</sup> /1.5 mm <sup>2</sup> with sleeve
Operating position:	vertical
Installation:	in the switchboard on DIN rail EN 60715
Dimensions:	90 x 105 x 65 mm (3.5" x 4.1" x 2.6")
Weight	320 g (11 oz.)
Standards:	ČSN EN 63044-1 ETSI, ČSN EN 300 220-2, ETSI ČSN EN 301489-3

**Description**

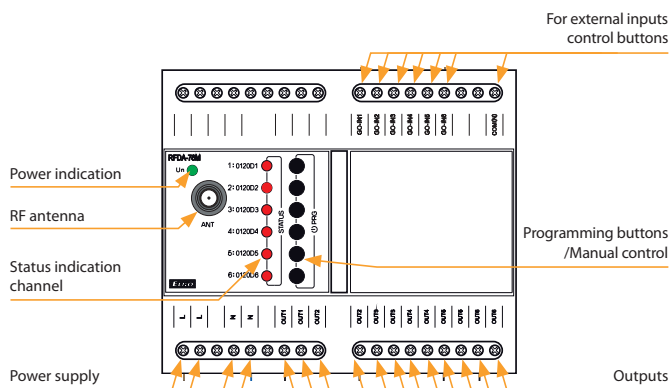

**Connection**

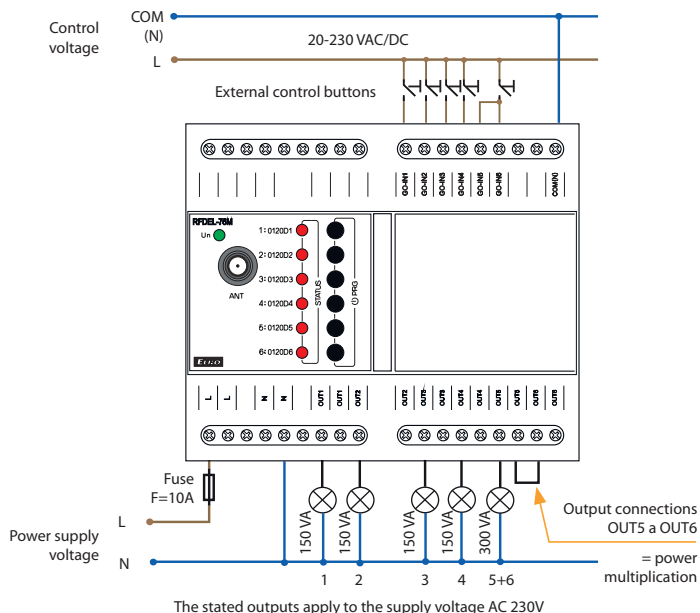

\*Warning: it is not allowed to simultaneously connect loads of inductive and capacitive type in the same channel.

**Types of connectable loads**

HAL 230 V	HAL 12-24 V			
R resistive	L inductive	C capacitive	ESL saving	LED light





**USS**  
Designed for switching, control and signalling of auxiliary and power circuits.

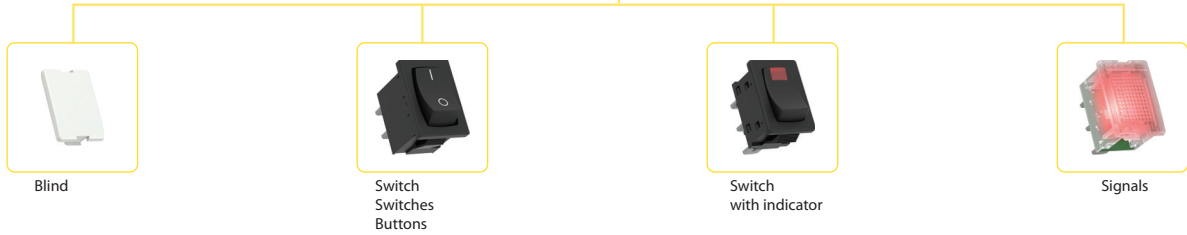

**USS | Controlling and signaling modules**

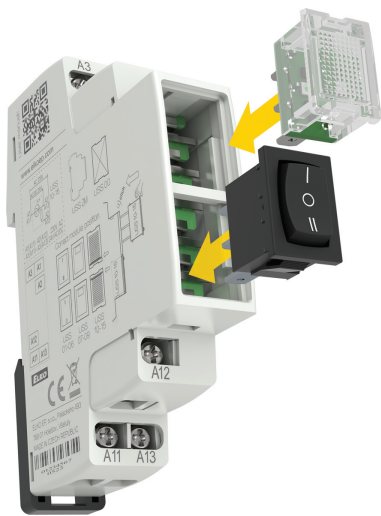

- Independent switch units designed for flexible controlling and switching of power circuits.
- USS - "Do It Yourself" = it is possible to "click into" different types of switches and signalling units into the basic module.
- Units are delivered as components and configured by the user.
- 16 types of units: switches, push buttons, signal lights of different colours including flashing lights units are replaceable also for future (for example when an application is changed, extended, etc...).
- Units are also replaceable in the future (for example when an application is changed, extended, etc...).
- It is possible to place up to two units into one MODULE (for example 2x switch, 2x signalling lights or combinations) = saves space in switch-board panels.
- 1-MODULE (90 x 17.6 x 64 mm/3.5" x 0.7" x 2.5"), DIN rail mounting.
- Operating temperature -20 °C to +55 °C (-4 °F to 131 °F).
- M3 screw with clamp terminals.

**Connection**

**Connection of signaling light**

**Installing the USS into the module**

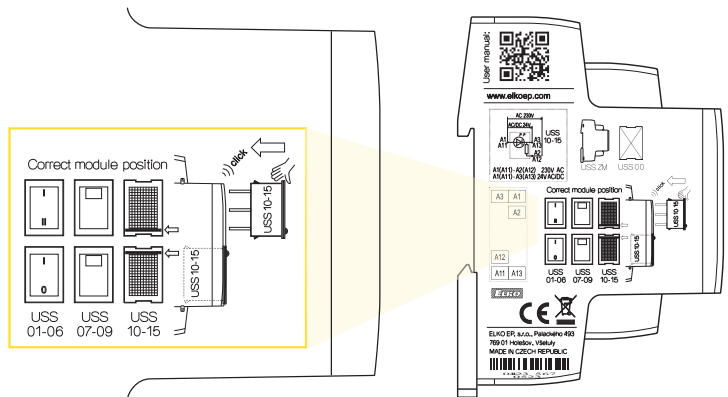
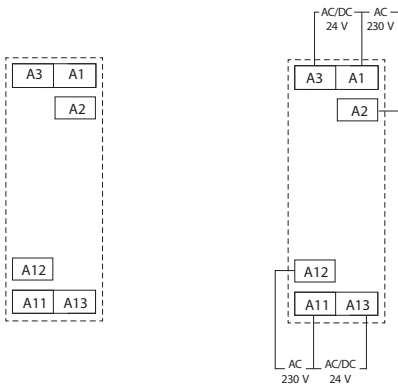

**Examples of mounting**



USS-01 + USS-03



USS-07 + USS-11



USS-11 + USS-01



USS-10 + USS-00



USS-10 + USS-11











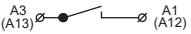

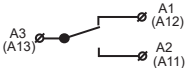

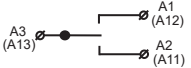
USS-07 + USS-00

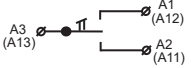

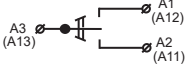

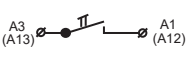

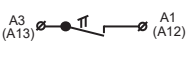
TYPE DESIGNATION	EAN CODE	CONNECTION	RATED CURRENT/VOLTAGE (FOR SWITCHES) SUPPLY VOLTAGE (FOR SIGNALING LIGHTS)	DIMENSIONS	DESCRIPTION
USS-ZM	8595188124577	MODULE	-	19 x 17.6 x 64 mm (0.75" x 0.69" x 2.5")	Basic MODULE (housing with terminals and contacts)
USS-00	8595188124614	BLIND FLANGE	-	21 x 15 x 7 mm (0.83" x 0.59" x 0.28")	Used to fill in an empty position in the front panel





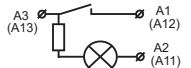

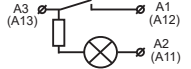





## Switches, push buttons

USS-01		8595188124621		6 A/250 V AC	21 x 15 x 20 mm (0.83" x 0.59" x 0.79")	Switch
USS-02		8595188124638		10 A/250 V AC	21 x 15 x 20 mm (0.83" x 0.59" x 0.79")	Alternation switch
USS-03		8595188124645		10 A/250 V AC	21 x 15 x 20 mm (0.83" x 0.59" x 0.79")	Switch with central position
USS-04		8595188124652		6 A/250 V AC	21 x 15 x 20 mm (0.83" x 0.59" x 0.79")	Switch + push with central position
USS-05		8595188124669		6 A/250 V AC	21 x 15 x 20 mm (0.83" x 0.59" x 0.79")	Push button with central position
USS-06/S		8595188124676		10 A/250 V AC	21 x 15 x 20 mm (0.83" x 0.59" x 0.79")	Push button NO
USS-06/R		8595188136372		10 A/250 V AC	21 x 15 x 20 mm (0.83" x 0.59" x 0.79")	Push button NC

## Switches with glow lamp

USS-07		8595188124683		6 A/250 V AC	21 x 15 x 20 mm (0.83" x 0.59" x 0.79")	Switch with glow lamp (red)
USS-08		8595188124690		6 A/250 V AC	21 x 15 x 20 mm (0.83" x 0.59" x 0.79")	Switch with glow lamp (green)
USS-09		8595188124706		6 A/250 V AC	21 x 15 x 20 mm (0.83" x 0.59" x 0.79")	Switch with glow lamp (yellow)

## Signaling light

USS-10		8595188124331		A1-A2, AC 230 V A1-A3, AC/DC 24 V	21 x 15 x 14 mm (0.83" x 0.59" x 0.55")	Signaling LED (red)
USS-11		8595188124348		A1-A2, AC 230 V A1-A3, AC/DC 24 V	21 x 15 x 14 mm (0.83" x 0.59" x 0.55")	Signaling LED (green)
USS-12		8595188124355		A1-A2, AC 230 V A1-A3, AC/DC 24 V	21 x 15 x 14 mm (0.83" x 0.59" x 0.55")	Signaling LED (yellow)
USS-13		8595188124362		A1-A2, AC 230 V A1-A3, AC/DC 24 V	21 x 15 x 14 mm (0.83" x 0.59" x 0.55")	Signaling LED (white)
USS-14		8595188124898		A1-A2, AC 230 V A1-A3, AC/DC 24 V	21 x 15 x 14 mm (0.83" x 0.59" x 0.55")	Signaling LED <b>FLASHING</b> (red)
USS-15		8595188124379		A1-A2, AC 230 V A1-A3, AC/DC 24 V	21 x 15 x 14 mm (0.83" x 0.59" x 0.55")	Signaling LED (blue)

1-phase

AC/DC



**HRN-31, HRN-31/2**  
Multifunction, supply and monitored voltage in range of AC/DC 48-276 V, 1x (HRN-31) / 2x (HRN-31/2) output for Umax and Umin with adjustable levels. page 89



**HRN-32/2**  
As HRN-31/2 but individual output for each level (Umax/Umin). page 89



**HRN-39, HRN-39/2**  
Multifunction, supply and monitored voltage in range of AC/DC 24-150 V, 1x (HRN-39) / 2x (HRN-39/2) output for Umax and Umin with adjustable levels. page 89



**PMR1-31, PMR1-31/2**  
Same as HRN-31 and HRN-31/2, but in PLUG-IN design. page 91



**PMR1-39, PMR1-39/2**  
Same as HRN-39 and HRN-39/2, but in PLUG-IN design. page 91

DC



**HRN-36, HRN-36/2**  
Multifunction, supply and monitored voltage in range of DC 6-30 V, 1x (HRN-36) / 2x (HRN-36/2) output for Umax and Umin with adjustable levels. page 89



**PMR1-36, PMR1-36/2**  
Same as HRN-36 and HRN-36/2, but in PLUG-IN design. page 91

AC/DC



**HRN-41**  
(HYSTERESIS function) monitoring AC/DC voltage 10-500 V, divided into 3 inputs and 3 ranges, 2 independent outputs 16 A, 2x time delay. page 93



**HRN-42**  
(WINDOW function). Other functions (applicable for HRN-41): faulty state memory, hysteresis, galv. isolated supply. page 93

3-phase



**HRN-55**  
Supply from all phases. page 95



**HRN-55N**  
Supply L1, L2, L3-N (monitors also disconnection of neutral wire). Time delay to eliminate peaks. page 95



**HRN-57**  
Supply from all phases. page 96



**HRN-57N**  
Supply L1, L2, L3-N (monitors also neutral wire disconnection). Adjustable voltage levels. page 96



**HRN-54**  
Supply from all phases. page 97



**HRN-54N**  
Supply L1, L2, L3-N (monitors also disconnection of neutral wire). All parameters adjustable by potentiometers. page 97



**HRN-56/208**  
Adjustable level Umin. page 98



**HRN-56/240**  
Adjustable level Umin. page 98



**HRN-56/400**  
Adjustable level Umin. page 98



**HRN-56/480**  
Adjustable level Umin. page 98



**HRN-56/575**  
Adjustable level Umin. page 98



**HRN3-81**  
Fixed range (208-480 V), asymmetry (2-10 % +OFF), 1x output contact, TRUE RMS. page 103



**HRN-43**  
Galvanically isolated supply AC/DC 24-240 V or AC 400, selectable memory, adjustable hysteresis and delay, 2 x independent output. page 99



**HRN-43N**  
Galvanically isolated supply AC/DC 24-240 V or AC 400, selectable memory, adjustable hysteresis and delay, 2 x independent output. page 99



**HRN-100**  
Possibility of 3/4-wire connection, allows monitoring lower and upper level of voltage and frequency, optionally allows monitoring phase failure, sequence, asymmetry incl. failure of neutral wire. page 105



**HRN3-70**  
Adjustable range (190-500 V), asymmetry (2-10 % +OFF), undervoltage (80-95 % from the range), restart delay (1-300 s), selectable memory, 2x output contact, TRUE RMS. page 101



**PMR3-70**  
Same as HRN3-70, but in PLUG-IN design and with 1x output contact. page 101



**HRN3-80**  
Adjustable range (208-480 V), asymmetry (2-10 % +OFF), undervoltage (80-95 % from the range), 1x output contact, TRUE RMS. page 103

Optical signaling in 3-phase network



**MPS-1**  
Optical signaling of 3-phase network. page 108

Power factor



**COS-2**  
Monitors and evaluates power factor (phase shift between current and voltage cos φ) in 3-phase/1-phase circuits (motors, pumps etc.). page 109

Frequency



**HRF-10**  
Used to monitor the frequency of AC voltage. Selectable monitored frequency 50/60/400 Hz, selected by a switch. page 111

Type	Design	Supply from	Galvanically isolated	Features				Phase			Setting				Description	Page	
				Phases	Monitored range	>U	<U	$\approx$ U	Failure	Sequence	Asymmetry	Delay	Restart delay	Hysteresis			Memory
HRN-31 HRN-31/2	1-M	monitored voltage	x	1	AC/DC 48 - 276 V	●	●	●	x	x	x	●	x	●	●	All types have 9 functions in total. The delay is adjustable from 0 - 10 seconds (to eliminate short-term outages or peaks). The lower voltage level (Umin) is set in % of the upper level (Umax).	89
HRN-32/2	1-M	monitored voltage	x	1	AC/DC 48 - 276 V	●	●	●	x	x	x	●	x	●	●		
HRN-36 HRN-36/2	1-M	monitored voltage	x	1	DC 6 - 30 V	●	●	●	x	x	x	●	x	●	●		
HRN-39 HRN-39/2	1-M	monitored voltage	x	1	AC/DC 24 - 150 V	●	●	●	x	x	x	●	x	●	●	HRN-3x, PMR1-3x: 1x output contact HRN-3x/2, PMR1-3x/2: 2x output contact  Old types replacement: HRN-33 > HRN-31 HRN-34 > HRN-36 HRN-35 > HRN-32/2 HRN-37 > HRN-39	91
PMR1-31 PMR1-31/2	8-PIN	monitored voltage	x	1	AC/DC 48 - 276 V	●	●	●	x	x	x	●	x	●	●		
PMR1-36 PMR1-36/2	8-PIN	monitored voltage	x	1	DC 6 - 30 V	●	●	●	x	x	x	●	x	●	●		
PMR1-39 PMR1-39/2	8-PIN	monitored voltage	x	1	AC/DC 24 - 150 V	●	●	●	x	x	x	●	x	●	●	HRN-32/2: separated output contact for overvoltage and undervoltage	
HRN-41/UNI HRN-41/400 V	3-M	AC/DC 24-240 V AC 400 V	●	1	AC/DC 50 V AC/DC 160 V AC/DC 500 V	x	x	●	x	x	x	●	x	●	●	Second relay function (independent or parallel). Galvanically separated power supply from measuring inputs. <b>HRN-41</b> : lower level for undervoltage (Umin) is set in % from the set upper level (Umax). <b>HRN-42</b> : lower level for undervoltage (Umin) is set in % of the nominal value of the selected input, as for the upper level (Umax).	93
HRN-42/UNI HRN-42/400 V	3-M	AC/DC 24-240 V AC 400 V	●	1	AC/DC 50 V AC/DC 160 V AC/DC 500 V	x	x	●	x	x	x	●	x	●	●		
HRN-55	1-M	monitored voltage	x	3	AC 3 x 300 - 500 V	x	x	● (fixed)	●	●	x	●	x	x	x	Power supply from all phases, i.e. the relay function is preserved even if one phase fails.	95
HRN-55N	1-M	monitored voltage	x	3	AC 3 x 172 - 287 V	x	x	● (fixed)	●	●	x	●	x	x	x	Power supply L1, L2, L3-N, i.e. the relay also monitors the neutral wire interruption.	95
HRN-57	1-M	monitored voltage	x	3	AC 3 x 300 - 500 V	x	x	●	●	x	x	●	x	x	x	Power supply from all phases, i.e. the relay function is preserved even if one phase fails.	96
HRN-57N	1-M	monitored voltage	x	3	AC 3 x 172 - 287 V	x	x	●	●	x	x	●	x	x	x	Power supply L1, L2, L3-N, i.e. the relay also monitors the neutral wire interruption.	96
HRN-54	1-M	monitored voltage	x	3	AC 3 x 300 - 500 V	x	x	●	●	●	x	●	x	x	x	Power supply from all phases, i.e. the relay function is preserved even if one phase fails.	97
HRN-54N	1-M	monitored voltage	x	3	AC 3 x 172 - 287 V	x	x	●	●	●	x	●	x	x	x	Power supply L1, L2, L3-N, i.e. the relay also monitors the neutral wire interruption.	97
HRN-43/UNI HRN-43/400 V	3-M	AC/DC 24-240 V AC 400 V	●	3	AC 3 x 84 - 480 V	x	x	●	●	●	● (+ OFF)	●	x	●	●	2 output relays, functions of the second relay may be selected (independent/parallel). Galvanically separated power supply.	99
HRN-43N/UNI HRN-43N/400 V	3-M	AC/DC 24-240 V AC 400 V	●	3	AC 3 x 48 - 276 V	x	x	●	●	●	● (+ OFF)	●	x	●	●		
HRN-56/208 HRN-56/240 HRN-56/400	1-M	monitored voltage	x	3	AC 3 x 125 - 276 V AC 3 x 144 - 276 V AC 3 x 240 - 460 V	x	●	x	●	●	x	●	x	x	x	Thanks to the power supply from all three phases, the relay is operational even if one phase fails.	98
HRN-56/480 HRN-56/575	3-M	monitored voltage	x	3	AC 3 x 228 - 550 V AC 3 x 345 - 660 V	x	●	x	●	●	x	●	x	x	x		
HRN3-70	3-M	monitored voltage	x	3	AC 3 x 190 - 500 V	x	x	● (o-fixed)	●	●	● (+ OFF)	●	●	x	●	Selectable nominal voltage from 190 to 500 V. Adjustable restart delay from 1 to 300 s. Two output contacts, changeover 16 A. * (o-fixed) = over voltage value is fixed (110% from selected range).	101
PMR3-70	8-PIN	monitored voltage	x	3	AC 3 x 190 - 500 V	x	x	● (o-fixed)	●	●	● (+ OFF)	●	●	x	●		
HRN3-80	1-M	monitored voltage	x	3	AC 3 x 208 - 480 V	x	●	x	●	●	● (+ OFF)	●	x	x	x	Selectable nominal voltage from 208 to 480 V.	103
HRN3-81	1-M	monitored voltage	x	3	AC 3 x 208 - 480 V	x	x	x	●	●	● (+ OFF)	●	x	x	x	Works in range from 208 to 480 V.	103
HRN-100	2-M	monitored voltage	x	3	U <sub>L</sub> = 3 ~ 155 - 500 V U <sub>LN</sub> = 3 ~ 90 - 288 V	●	●	●	●	●	●	●	●	●	●	Configurable 3 or 4-wire connection. Extensive setting options. Each output can be configured individually.	105

## Relay for optical signalization in 3-phase network

MPS-1	1-M	monitored voltage	3	AC 3 x 50 - 253 V	x	●	●	●	x	x	x	Optical signaling of three-phase network.				108
-------	-----	-------------------	---	-------------------	---	---	---	---	---	---	---	---	--	--	--	-----

## Relay for frequency monitoring

Type	Design	Supply/monitored voltage	Phases	Monitored parameters			Setting				Description	Page	
				Frequency range	Frequency $\wedge$	Frequency $\vee$	Delay	Hysteresis	Frequency $\wedge$	Frequency $\vee$			
HRF-10	3-M	AC 161 - 500 V	1	40 - 60 Hz 48 - 72 Hz 320 - 480 Hz	●	●	●	●	●	●	●	Switchable ranges of rated frequency.	111

## Relay for power factor monitoring

Type	Design	Supply voltage	Phases	Monitored parameters			Setting			Description	Page	
				Range cos $\phi$	> cos $\phi$	< cos $\phi$	Delay	Hysteresis	Memory fault			
COS-2/230 V COS-2/110 V COS-2/400 V COS-2/24 V	3-M	AC 230 V AC 110 V AC 400 V AC/DC 24 V	3	0.1 - 0.99	●	●	●	●	●	●	Configurable 3 or 4-wire connection. Extensive setting options. Each output can be configured individually.	109



- It is used to monitor the value of alternating or direct voltage in 1-phase circuits.
- Supply voltage from monitored voltage.
- Monitors voltage exceeding the upper voltage level (Umax) and falling below the lower voltage level (Umin) – according to the selected function.
- Smooth adjustment of both voltage levels – the lower level Umin is set in % of the upper level Umax.
- Adjustable time delay (to eliminate short-term voltage drops and spikes).
- Option to select functions with fault state memory (Latch).
- The fault state memory can be reset by the control input (R).
- Measures true root mean square value of the voltage - TRUE RMS.
- Type HRN-32/2 has an independent output contact for each voltage level.

EAN code  
 HRN-31: 8595188184946  
 HRN-31/2: 8595188184380  
 HRN-32/2: 8595188185394  
 HRN-36: 8595188184953  
 HRN-36/2: 8595188182553  
 HRN-39: 8595188184960  
 HRN-39/2: 8595188184939

Technical parameters	HRN-31 HRN-31/2	HRN-32/2	HRN-36 HRN-36/2	HRN-39 HRN-39/2
----------------------	--------------------	----------	--------------------	--------------------

Supply and measuring	A1-A2			
Supply/monitored terminals:	A1-A2			
Supply/monitored voltage:	AC/DC 48 – 276 VAC/DC 48 – 276 V (AC 50-60 Hz)	AC 50-60 Hz	DC 6 – 30 V	AC/DC 24 – 150 V (AC 50-60 Hz)
Consumption (max.):	2.5 VA/0.55 W 2.7 VA/0.65 W	2.7 VA/0.65 W	0.35 W 0.5 W	2.5 VA/0.55 W 2.7 VA/0.65 W
Upper level setting (Umax):	AC 160 – 276 V	AC 160 – 276 V	DC 12 – 30 V	AC 80 – 150 V
Lower level setting (Umin):	30 – 95 %Umax	30 – 95 %Umax	50 – 95 %Umax	30 – 95 %Umax
Max. permanent voltage:	AC 276 V	AC 276 V	DC 36 V	AC 276 V
Peak overload (1 s):	AC 290 V	AC 290 V	DC 48 V	AC 290 V
Time delay (d):	300 ms			
Time delay (t):	adjustable, 0.5 – 10 s			

Accuracy	5% – mechanical setting			
Setting accuracy (mech.):	5% – mechanical setting			
Repeat accuracy:	< 1%			
Temperature dependency:	< 0.1 %/°C (°F)			
Hysteresis	5% (functions O1, U1, W)			
(fault to OK):	Umax – Umin (functions O2, U2, U3)			

Output	1x changeover			
Contact type:	1x changeover 2x changeover	1x changeover for each level	1x changeover 2x changeover	1x changeover 2x changeover
Contact material:	AgNi			
Current rating:	16 A/AC1; 1 HP 240 Vac, 1/2 HP 120 Vac; PD. B300			
Breaking capacity:	4000 VA/AC1, 384 W/DC1			
Switching voltage:	250 V AC/24 V DC			
Power dissipation (max.):	HRN-3x (1.2 W)   HRN-3x/2 (2.4 W)			
Mechanical life:	10.000.000 ops.			
Electrical life (AC1):	100.000 ops.			

Other information	-20 .. +55 °C (-4 .. 131 °F)			
Operating temperature:	-20 .. +55 °C (-4 .. 131 °F)			
Storage temperature:	-30 .. +70 °C (-22 .. 158 °F)			
Dielectric strength:	AC 4 kV (supply – output)			
Operating position:	any			
Mounting:	DIN rail EN 60715			
Protection degree:	IP40 front panel / IP20 terminals			
Overvoltage category:	III.			
Pollution degree:	2			
Cross-wire section – solid/ stranded with ferrule (mm <sup>2</sup> ):	max. 1x 2.5, 2x 1.5/ max. 1x 2.5 (AWG 14)			
Dimensions:	90 x 17.6 x 64 mm (3.5" x 0.7" x 2.5")			
Weight:	60 g (2.11 oz)	80 g (2.82 oz)	59 g (2.08 oz)	60 g (2.11 oz)
Standards:	EN 60255-1, EN 60255-26, EN 60255-27			

Description

HRN-31/2

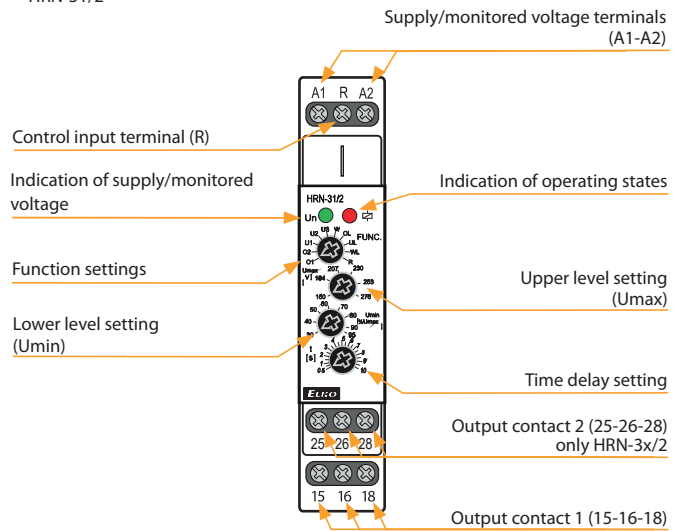

Connection

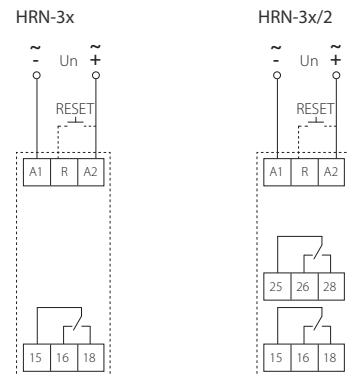

Indication of operating states

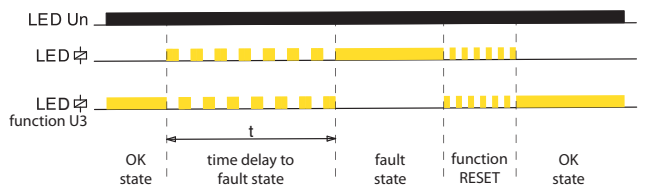

## Function

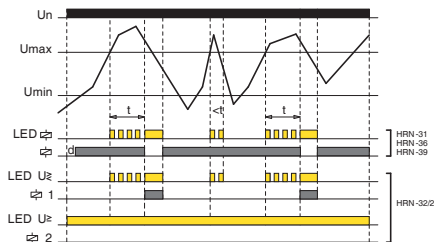
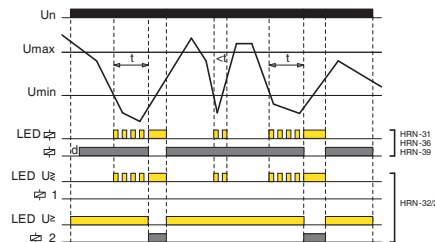
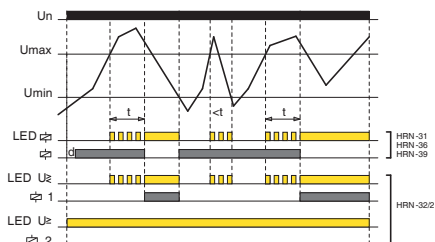
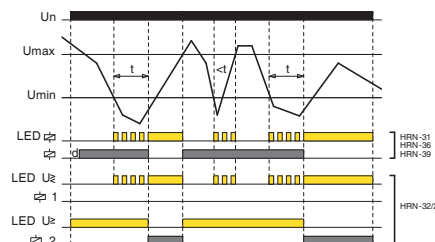
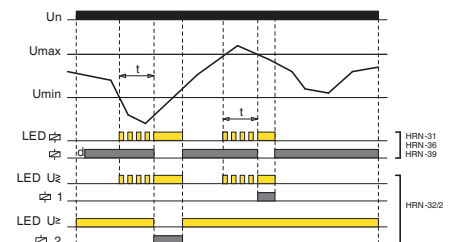
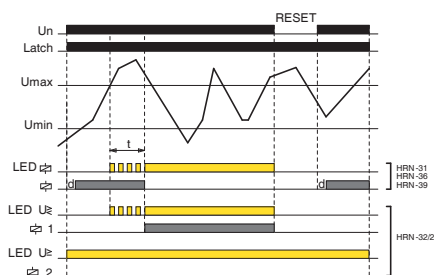
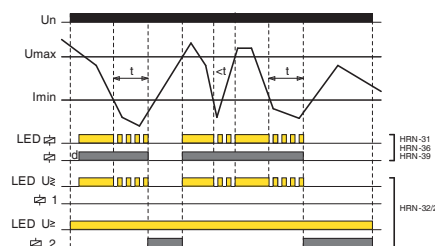
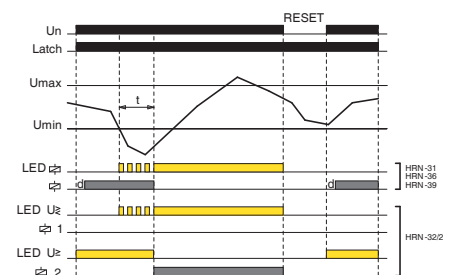
**O1** OVER (hysteresis 5%)**U1** UNDER (hysteresis 5%)**UL** UNDER + Latch**O2** OVER (hysteresis to  $U_{min}$ )**U2** UNDER (hysteresis to  $U_{max}$ )**W** WINDOW (hysteresis 5%)**OL** OVER + Latch**U3** UNDER (hysteresis to  $U_{max}$ )**WL** WINDOW + Latch**OVER:**

If the value of the monitored voltage is lower than the set upper level „ $U_{max}$ “, the output contact is closed. If the „ $U_{max}$ “ is exceeded, the output contact will opens after the set delay (fault state).

If the voltage falls below the fixed hysteresis (O1 function) or the set lower level „ $U_{min}$ “ (O2 function), the output contact will closes again.

If the OL function (OVER + Latch) is selected, when the upper voltage level „ $U_{max}$ “ is exceeded, the output contact remains open even when the voltage returns from the fault state.

**Fault memory reset can be done in three ways:**

- Short-term interruption of supply voltage
- Using the control input (R)
- By setting the function switch to position R (RESET) or any function without memory fault

The RESET state lasts for 3 s after switching the function switch from the R position to a function with a memory fault (UL, OL, WL).

When moving to any other function from the R position, this delay does not apply.

**UNDER:**

If the value of the monitored voltage is higher than the set lower level „ $U_{min}$ “, the output contact is closed. When the voltage drops below the „ $U_{min}$ “, output contact opens after the set delay (fault state).

If the voltage exceeds the fixed hysteresis (function U1) or the set upper level „ $U_{max}$ “ (function U2, U3), the output contact closes again.

If the UL function (UNDER + Latch) is selected, when the voltage drops below the lower level „ $U_{min}$ “, the output contact remains open even when returning from the fault state. Fault memory reset can be done as in the previous case.

**WINDOW:**

If the value of the monitored voltage is lower than upper level „ $U_{max}$ “ and at the same time higher than lower level „ $U_{min}$ “, the output contact in closed. If the „ $U_{max}$ “ is exceeded or drops below the „ $U_{min}$ “, output contact opens after the set delay (fault state).

To return from the fault state, a fixed hysteresis is applied.

If the WL function (WINDOW + Latch) is selected, the fault state is again stored in memory and output contact stays open, even when returning from the fault state. Fault memory reset can be done as in the previous cases.





EAN code  
 PMR1-31: (8595188188654)  
 PMR1-31/2: (8595188185363)  
 PMR1-36: (8595188188661)  
 PMR1-36/2: (8595188188678)  
 PMR1-39: (8595188188685)  
 PMR1-39/2: (8595188188692)

- It is used to monitor the value of alternating or direct voltage in 1-phase circuits.
- Supply voltage from monitored voltage.
- Monitors voltage exceeding the upper voltage level (Umax) and falling below the lower voltage level (Umin) – according to the selected function.
- Smooth adjustment of both voltage levels – the lower level Umin is set in % of the upper level Umax.
- Adjustable time delay (to eliminate short-term voltage drops and peaks).
- Option to select functions with fault state memory (Latch).
- The fault state memory can be reset with a button on the panel (RESET).
- Measures true root mean square value of the voltage - TRUE RMS.

Technical parameters	PMR1-31 PMR1-31/2	PMR1-36 PMR1-36/2	PMR1-39 PMR1-39/2
<b>Supply and measuring</b>			
Supply/monitored terminals:	2-7		
Supply/monitored voltage:	AC/DC 48 – 276 V (AC 50-60 Hz)	DC 6 – 30 V -	AC/DC 24 – 150 V (AC 50-60 Hz)
Consumption (max.):	2.5 VA/0.55 W 2.7 VA/0.65 W	0.35 W 0.5 W	2.5 VA/0.55 W 2.7 VA/0.65 W
Upper level setting (Umax):	AC 160 – 276 V	DC 12 – 30 V	AC 80 – 150 V
Lower level setting (Umin):	30 – 95 %Umax	50 – 95 %Umax	30 – 95 %Umax
Max. permanent voltage:	AC 276 V	DC 36 V	AC 276 V
Peak overload (1 s):	AC 290 V	DC 48 V	AC 290 V
Time delay (d):	300 ms		
Time delay (t):	adjustable, 0.5 – 10 s		
<b>Accuracy</b>			
Setting accuracy (mech.):	5 % – mechanical setting		
Repeat accuracy:	< 1 %		
Temperature dependency:	< 0.1 %/°C (°F)		
Hysteresis (fault to OK):	5 % (functions O1, U1, W) Umax – Umin (functions O2, U2, U3)		
<b>Output</b>			
Contact type:	1× changeover 2× changeover	1× changeover 2× changeover	1× changeover 2× changeover
Contact material:	AgNi		
Current rating:	16 A/AC1; 1 HP 240 Vac, 1/2 HP 120 Vac; PD. B300		
Breaking capacity:	4000 VA/AC1, 384 W/DC1		
Switching voltage:	250 V AC/24 V DC		
Power dissipation (max.):	PMR1-3x (1.2 W)   PMR1-3x/2 (2.4 W)		
Mechanical life:	10.000.000 ops.		
Electrical life (AC1):	100.000 ops.		
<b>Other information</b>			
Operating temperature:	–20 .. 55 °C (–4 .. 131 °F)		
Storage temperature:	–30 .. 70 °C (–22 .. 158 °F)		
Dielectric strength:	AC 4 kV (supply – output)		
Operating position:	any		
Mounting:	DIN rail EN 60715		
Protection degree:	IP40 front panel / IP20 terminals		
Overtoltage category:	III.		
Pollution degree:	2		
Dimensions:	48 × 48 × 79 mm (1.89" × 1.89" × 3.11")		
Weight:	94 g (3.32 oz) 105 g (3.7 oz)	94 g (3.32 oz) 105g (3.7 oz)	94 g (3.32 oz) 105g (3.7 oz)
Standards:	EN 60255-1, EN 60255-26, EN 60255-27		

**Description**

PMR1-31

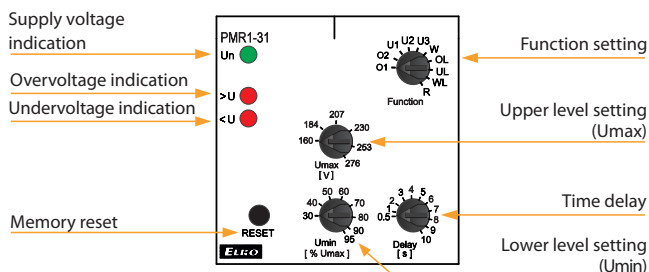

**Connection**

PMR1-3x

PMR1-3x/2

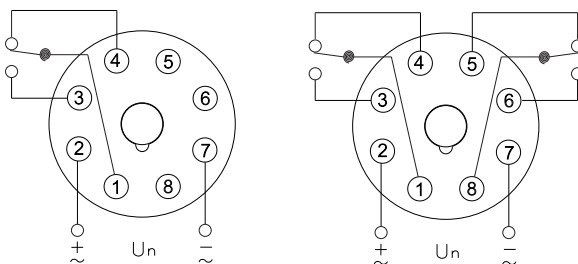

**Indication of operating states**

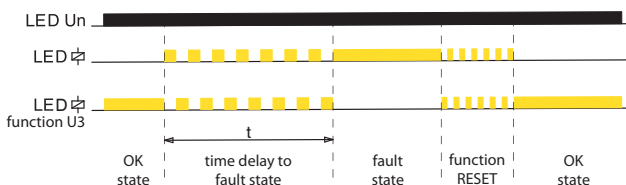

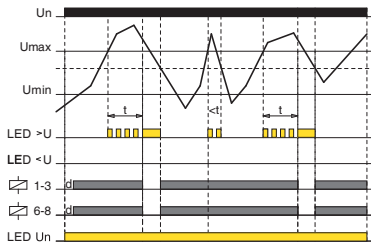
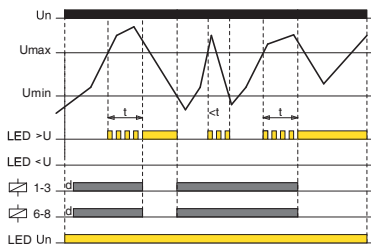
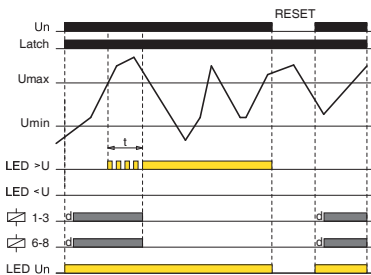
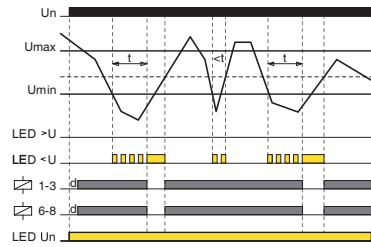
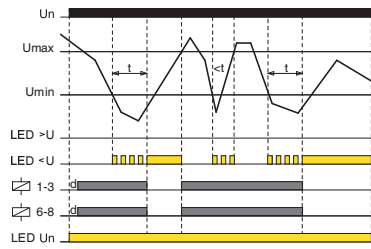
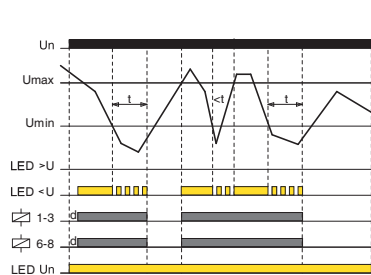
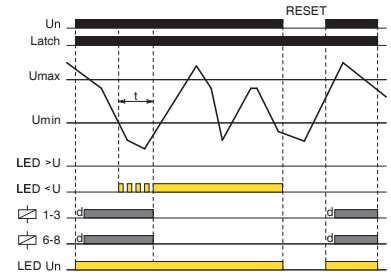
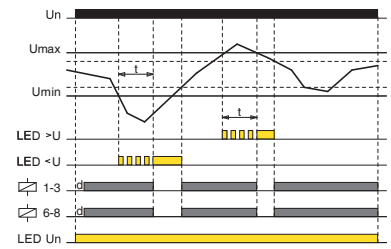
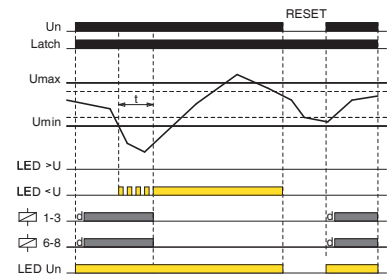

**O1 OVER (hysteresis 5%)****O2 OVER (hysteresis to  $U_{min}$ )****OL OVER + Latch****U1 UNDER (hysteresis 5%)****U2 UNDER (hysteresis to  $U_{max}$ )****U3 UNDER (hysteresis to  $U_{max}$ )****UL UNDER + Latch****W WINDOW (hysteresis 5%)****WL WINDOW + Latch****OVER:**

If the value of the monitored voltage is lower than the set upper level „ $U_{max}$ “, the output contact is closed. If the „ $U_{max}$ “ is exceeded, the output contact will open after the set delay (fault state).

If the voltage falls below the fixed hysteresis (O1 function) or the set lower level „ $U_{min}$ “ (O2 function), the output contact will close again.

If the OL function (OVER + Latch) is selected, when the upper voltage level „ $U_{max}$ “ is exceeded, the output contact remains open even when the voltage returns from the fault state.

**Fault memory reset can be done in three ways:**

- Using memory reset button on the panel
- Short-term interruption of supply voltage
- By setting the function switch to position R (RESET) or any function without memory fault

The RESET state lasts for 3 s after switching the function switch from the R position to a function with a memory fault (UL, OL, WL).

When moving to any other function from the R position, this delay does not apply.

**UNDER:**

If the value of the monitored voltage is higher than the set lower level „ $U_{min}$ “, the output contact is closed. When the voltage drops below the „ $U_{min}$ “, output contact opens after the set delay (fault state).

If the voltage exceeds the fixed hysteresis (function U1) or the set upper level „ $U_{max}$ “ (function U2, U3), the output contact closes again.

If the UL function (UNDER + Latch) is selected, when the voltage drops below the lower level „ $U_{min}$ “, the output contact remains open even when returning from the fault state. Fault memory reset can be done as in the previous case.

**WINDOW:**

If the value of the monitored voltage is lower than upper level „ $U_{max}$ “ and at the same time higher than lower level „ $U_{min}$ “, the output contact is closed. If the „ $U_{max}$ “ is exceeded or drops below the „ $U_{min}$ “, output contact opens after the set delay (fault state).

To return from the fault state, a fixed hysteresis is applied.

If the WL function (WINDOW + Latch) is selected, the fault state is again stored in memory and output contact stays open, even when returning from the fault state. Fault memory reset can be done as in the previous cases.



EAN code  
 HRN-41/UNI: 8595188185295  
 HRN-41/400V: 8595188140423  
 HRN-42/UNI: 8595188185301

Technical parameters	HRN-41	HRN-42	
<b>Supply</b>			
Supply terminals:	A1-A2		
Supply voltage:	AC/DC 24 – 240 V (AC 50-60 Hz)		
Consumption (max.):	3 VA/1 W		
Supply voltage:	AC 400 V (50-60 Hz)		
Consumption (max.):	5 VA/2.5 W		
Supply voltage tolerance:	-15 %; +10 %		
<b>Measuring</b>			
Monitored terminals:	C-B1	C-B2	C-B3
Monitored ranges*:	AC/DC 10 – 50 V (AC 50-60 Hz)	AC/DC 32 – 160 V (AC 50-60 Hz)	AC/DC 100 – 500 V (AC 50-60 Hz)
Input resistance:	212 kΩ	676 kΩ	2.12 MΩ
Max. permanent voltage:	100 V	300 V	600 V
Peak overload (1 s):	250 V	700 V	1 kV
Time delay Umax (t1):	adjustable, 0.1 – 10 s		
Time delay Umin (t2):	adjustable, 0.1 – 10 s		
<b>Accuracy</b>			
Setting accuracy (mech.):	5 %		
Repeat accuracy:	< 1 %		
Temperature dependence:	< 0.1 %/°C (°F)		
Limit values tolerance:	5 %		
Hysteresis (fault to OK):	selectable, 5 %/10 % from the upper range value		
<b>Output</b>			
Contact type:	2x changeover/SPDT (AgNi)		
Current rating:	16 A/AC1; 1 HP 240 Vac, 1/2 HP 120 Vac; PD. B300		
Breaking capacity:	4000 VA/AC1, 384 W/DC1		
Inrush current:	30 A / < 3 s		
Switching voltage:	250 V AC/24 V DC		
Power dissipation (max.):	2.4 W		
Mechanical life:	10.000.000 ops.		
Electrical life (AC1):	100.000 ops.		
<b>Other information</b>			
Operating temperature:	-20 .. +55 °C (-4 .. 131 °F)		
Storage temperature:	-30 .. +70 °C (-22 .. 158 °F)		
Dielectric strength:	supply – output AC 4 kV output 1 – output 2 AC 4 kV		
Operating position:	any		
Mounting:	DIN rail EN 60715		
Protection degree:	IP40 front panel / IP20 terminals		
Overtoltage category:	III.		
Pollution degree:	2		
Cross-wire section – solid/ stranded with ferrule (mm²):	max. 1x 2.5, 2x 1.5/ max. 1x 2.5 (AWG 14)		
Dimensions:	90 x 52 x 65 mm (3.5" x 2" x 2.6")		
Weight:	UNI – 148 g (5.2 oz), 400 V – 249 g (8.8 oz)		
Standards:	EN 60255-1, EN 60255-26, EN 60255-27		

\* Only one input can be monitored at a time.

- Relay is used for monitoring AC or DC voltage in three ranges.
- Monitors level of voltage in two independent levels (Umin, Umax).
- Setting the monitored upper level (Umax) in % of range.
- Setting the monitored lower level (Umin):  
in % of the set upper limit (HRN-41, function HYSTERESIS)  
in % of range (HRN-42, function WINDOW)
- Independent function of output contacts (independently/in parallel).
- Independent adjustable time delay of both levels (eliminating short-term drops and spikes).
- Galvanically separated power supply from monitoring inputs.
- Output contact for each monitored voltage level.

**Description**

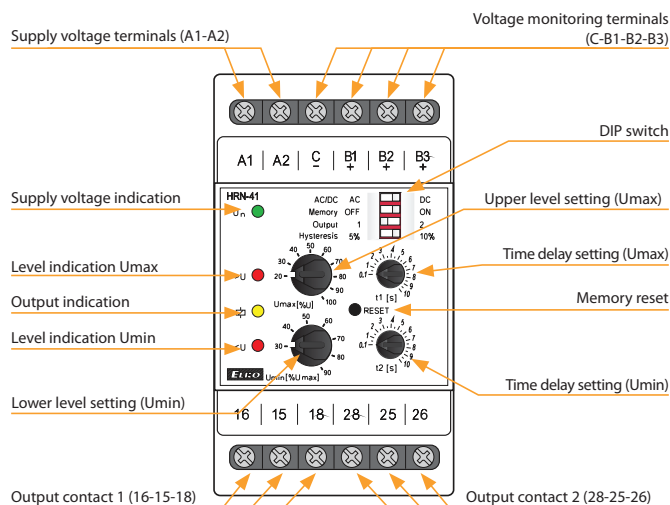

**Description of DIP switch**

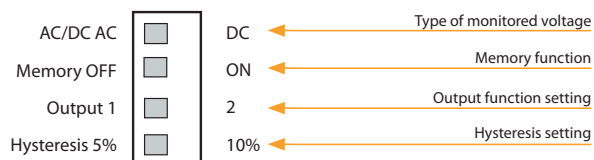

**Connection**

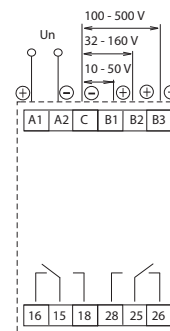

**Symbol**

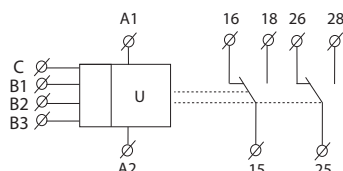

## Function

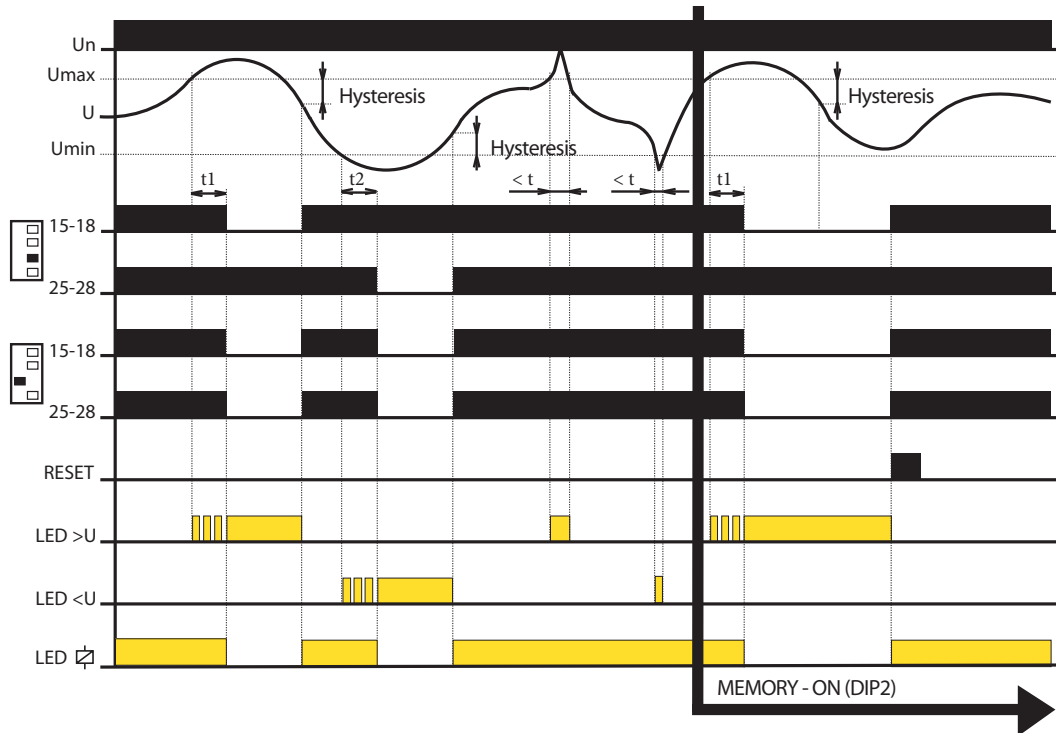

- If the value of the monitored voltage is in the zone between the set upper and lower levels, the OK state occurs, both output contacts are closed and the yellow LED illuminates. If the value of the monitored voltage is outside the set limits ( $> U_{max}$  or  $< U_{min}$ ), a fault state occurs.
- When moving to a fault state ( $U > U_{max}$ ), time delay  $t_1$  is running and red LED  $>U$  simultaneously flashes. After the time  $t_1$  elapses, the red LED  $>U$  illuminates and the relevant output contact opens.
- When moving to a fault state ( $U < U_{min}$ ), time delay  $t_2$  is running and red LED  $<U$  simultaneously flashes. After the time  $t_2$  elapses, the red LED  $<U$  illuminates and the relevant output contact opens.
- When moving from a fault state to the OK state, the relevant red LED immediately goes out, and the corresponding output contact closes.



EAN code  
 HRN-55: 8595188137225  
 HRN-55N: 8595188137232

Technical parameters	HRN-55	HRN-55N
Monitoring terminals:	L1, L2, L3	L1, L2, L3, N
Supply terminals:	L1, L2, L3	L1, L2, L3, N
Voltage:	3x 400 V (50-60 Hz)	3x 400 V/230 V (50-60 Hz)
Burden:	max. 2 VA/1 W	
Max. dissipated power (Un + terminals):	1 W	
Level Umax:	125 % Un	
Level Umin:	75 % Un	
Hysteresis:	2 %	
Max. permanent:	AC 3x 460 V	AC 3x 265 V
Peak overload <1ms:	AC 3x 500 V	AC 3x 288 V
Time delay t1:	max. 500 ms	
Time delay t2:	adjustable 0.1 - 10 s	
Time delay t3:	max. 1 s	
<b>Output</b>		
Number of contacts:	1x changeover/SPDT (AgNi/Silver Alloy)	
Current rating:	8 A/AC1; 1/3 HP 240 Vac, 1/4 HP 120 Vac; PD. B300	
Breaking capacity:	2000 VA/AC1, 240 W/DC	
Inrush current:	10 A	
Switching voltage:	250 V AC/24 V DC	
Output indication:	red LED	
Mechanical life:	60.000.000 ops.	
Electrical life (AC1):	150.000 ops.	
<b>Other information</b>		
Operating temperature:	-20 .. 55 °C (-4 .. 131 °F)	
Storage temperature:	-30 .. 70 °C (-22 .. 158 °F)	
Electrical strength:	4 kV (supply - output)	
Operating position:	any	
Mounting:	DIN rail EN 60715	
Protection degree:	IP40 from front panel/IP10 terminals	
Overvoltage category:	III.	
Pollution degree:	2	
Max. cable size (mm <sup>2</sup> ):	solid wire max. 2x 2.5 or 1x 4 with sleeve max. 1x 2.5 or 2x 1.5 (AWG 12)	
Dimensions:	90 x 17.6 x 64 mm (3.5" x 0.7" x 2.5")	
Weight:	61 g (2.15 oz.)	63 g (2.22 oz.)
Standards:	EN 60255-1, EN 60255-26, EN 60255-27	

**Function description**

Relay in 3-phase main monitors correct phase sequence and failure of any phase. Green LED is permanently ON and indicates presence of power supply voltage. In case of phase failure or exceeding voltage level red LED flashes and relay breaks. When changing to faulty state, time delay applies. Time delay setting is set by a potentiometer on front panel of the device. In case of incorrect phase sequence red LED shines permanently and relay is open. In case supply voltage falls below 60 % Un (OFF lower level) relay immediately opens with no delay and faulty state is indicated by red LED.

**HRN-55** - thanks to supply form all phases, this relay is able to stay operational also if one phase is out.

**HRN-55N** -supply L1, L2, L3-N, means that relay monitor also failure in neutral wire.

- Relay monitors phase sequence and failure, exceeding of monitored voltage in 3-phase main.
- **HRN-55**: supply from all phases, which means that function of relay is applicable also if 1-phase fails.
- **HRN-55N**: supply L1, L2, L3-N, it means that relay also monitors break of neutral point.
- Fixed delay t1 (500 ms), adjustable delay t2 (0.1 - 10 s) and fixed delay t3 (max. 1 s).

**Description**

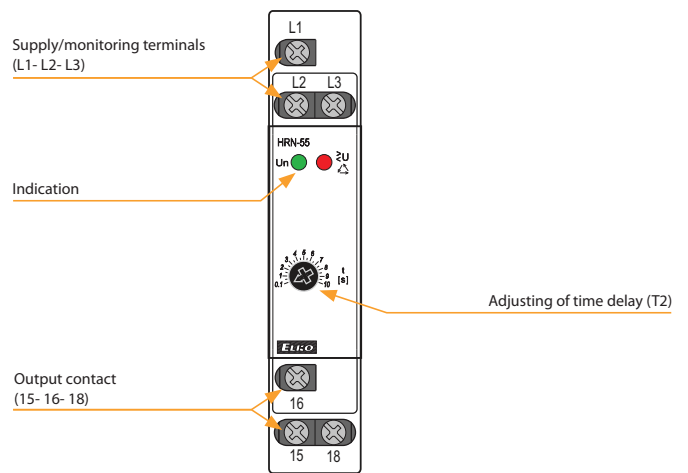

**Function**

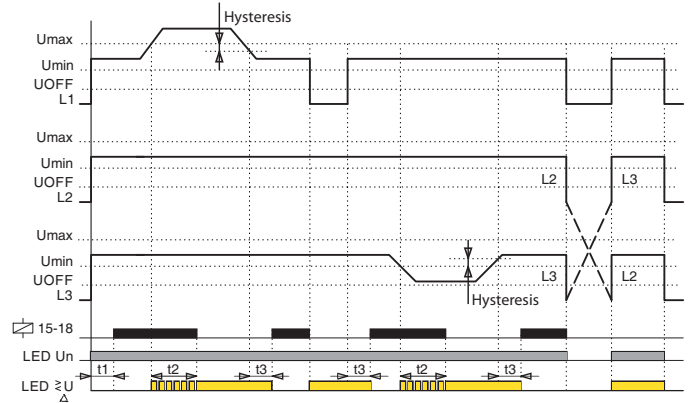

**Connection**

**Symbol**

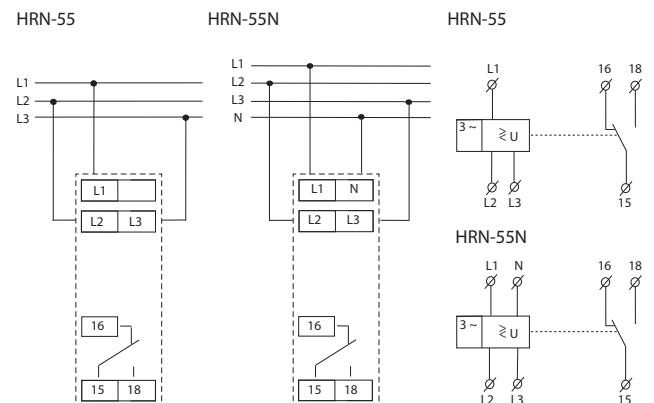



EAN code  
HRN-57: 8595188137256  
HRN-57N: 8595188137249

Technical parameters	HRN-57	HRN-57N
Monitoring terminals:	L1, L2, L3	L1, L2, L3, N
Supply terminals:	L1, L2, L3	L1, L2, L3, N
Voltage:	3x 400 V (50-60 Hz)	3x 400 V/230 V (50-60 Hz)
Burden:	max. 2 VA/1 W	
Max. dissipated power (Un + terminals):	2 W	
Level Umax:	105 - 125 % Un	
Level Umin:	75 - 95 % Un	
Hysteresis:	2 %	
Max. permanent overload:	AC 3x 460 V	AC 3x 265 V
Peak overload <1ms:	AC 3x 500 V	AC 3x 288 V
Time delay t1:	max. 500 ms	
Time delay t2:	adjustable 0.1-10 s	
Time delay t3:	max. 1 s	
<b>Output</b>		
Number of contacts:	1x changeover/SPDT (AgNi/Silver Alloy)	
Current rating:	8 A/AC1; 1/3 HP 240 Vac, 1/4 HP 120 Vac; PD. B300	
Breaking capacity:	2000 VA/AC1, 240 W/DC	
Inrush current:	10 A	
Switching voltage:	250 V AC/24 V DC	
Output indication:	red LED	
Mechanical life:	60.000.000 ops.	
Electrical life (AC1):	150.000 ops.	
<b>Other information</b>		
Operating temperature:	-20 .. 55 °C (-4 .. 131 °F)	
Storage temperature:	-30 .. 70 °C (-22 .. 158 °F)	
Electrical strength:	4 kV (supply - output)	
Operating position:	any	
Mounting:	DIN rail EN 60715	
Protection degree:	IP40 from front panel/IP10 terminals	
Oversvoltage category:	III.	
Pollution degree:	2	
Max. cable size (mm <sup>2</sup> ):	solid wire max. 2x 2.5 or 1x 4/ with sleeve max. 1x 2.5 or 2x 1.5 (AWG 12)	
Dimensions:	90 x 17.6 x 64 mm (3.5" x 0.7" x 2.5")	
Weight:	62 g (2.19 oz.)	63 g (2.22 oz.)
Standards:	EN 60255-1, EN 60255-26, EN 60255-27	

### Function description

Relay in 3-phase main monitors size of phase voltage. It is possible to set two independent voltage levels and thus it is possible to set two independent voltage levels and monitor e.g. undervoltage and overvoltage independently. In normal state when voltage is within set levels, output relay is closed and red LED shines. In case supply voltage falls below 60 % Un (U<sub>OFF</sub> lower level) relay immediately breaks without delay and faulty state is indicated by red LED. In case voltage exceeds or falls below the set levels, output relay breaks and red LED shines (LED indicates faulty state - flashes when timing). In case timing is in progress and faulty state is indicated, timing is immediately stopped.

- It serves to monitor voltage in a switchboard, protection of devices in 3-phase main.
- It monitors value of voltage in 3-phase main.
- It is possible to set upper and lower level independently.
- Adjustable time delay eliminated short voltage peaks and failures in the main.
- Relay doesn't monitor phase sequence.
- **HRN-57:** supply from all phases, means that relay is functional also in case of failure in one phase.
- **HRN-57N:** supply L1, L2, L3-N, means that relay monitors also failure of neutral wire.

### Description

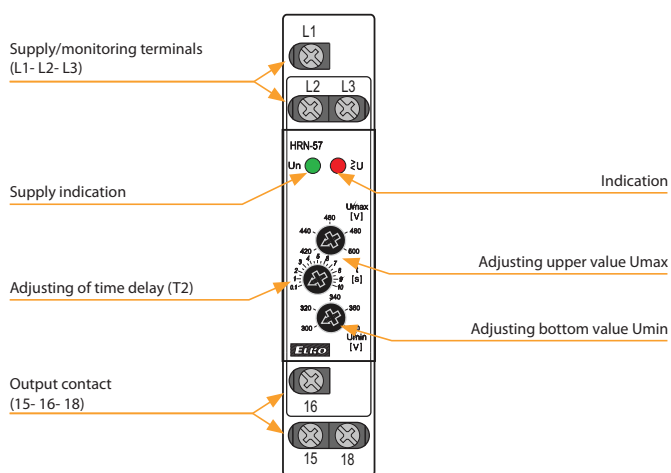

### Function

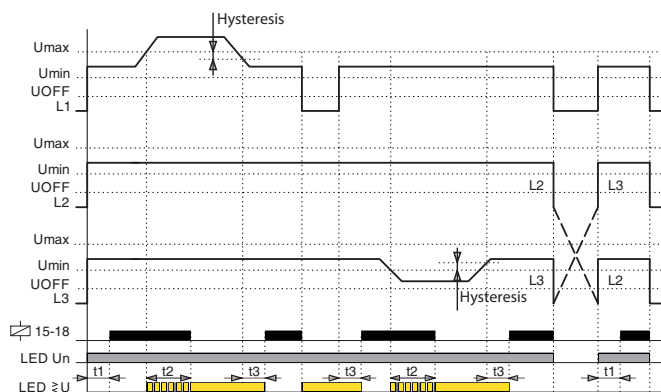

### Connection

### Symbol

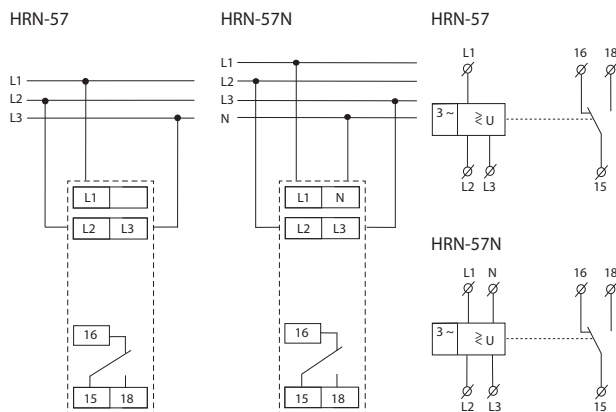



EAN code  
 HRN-54: 8595188137201  
 HRN-54N: 8595188137218

Technical parameters	HRN-54	HRN-54N
Supply and measuring:	L1, L2, L3	L1, L2, L3, N
Supply terminals:	L1, L2, L3	L1, L2, L3, N
Supply/measured voltage:	3x 400 V (50-60 Hz)	3x 400 V/230 V (50-60 Hz)
Burden:	max. 2 VA/1 W	
Max. dissipated power (Un + terminals):	1 W	
Level Umax:	105 - 125 % Un	
Level Umin:	75 - 95 % Un	
Hysteresis:	2 %	
Max. permanent overload:	AC 3x 460 V	AC 3x 265 V
Peak overload <1ms:	AC 3x 500 V	AC 3x 288 V
Time delay t1:	max. 500 ms	
Time delay t2:	adjustable 0.1-10 s	
Time delay t3:	max. 1 s	
<b>Output</b>		
Number of contacts:	1x changeover/SPDT (AgNi/Silver Alloy)	
Current rating:	8 A/AC1; 1/3 HP 240 Vac, 1/4 HP 120 Vac; PD. B300	
Breaking capacity:	2000 VA/AC1, 240 W/DC	
Inrush current:	10 A	
Switching voltage:	250 V AC/24 V DC	
Indication of state:	red LED	
Mechanical life:	60.000.000 ops.	
Electrical life (AC1):	150.000 ops.	
<b>Other information</b>		
Operating temperature:	-20 .. 55 °C (-4 .. 131 °F)	
Storage temperature:	-30 .. 70 °C (-22 .. 158 °F)	
Electrical strength:	4 kV (supply - output)	
Operating position:	any	
Mounting:	DIN rail EN 60715	
Protection degree:	IP40 from front panel/IP10 terminals	
Overvoltage category:	III.	
Pollution degree:	2	
Max. cable size (mm <sup>2</sup> ):	solid wire max. 2x 2.5 or 1x 4/ with sleeve max. 1x 2.5 or 2x 1.5 (AWG 12)	
Dimensions:	90 x 17.6 x 64 mm (3.5" x 0.7" x 2.5")	
Weight:	62 g (2.19 oz.)	63 g (2.22 oz.)
Standards:	EN 60255-1, EN 60255-26, EN 60255-27	

**Function description**

Relay in 3-phase main monitors size of phase voltage. It is possible to set two independent voltage levels and thus it is possible to set two independent voltage levels and monitor e.g. undervoltage and overvoltage independently. In normal state when voltage is within set levels, output relay is closed and red LED shines. In case voltage exceeds or falls below the set levels, output relay opens and red LED shines (LED indicates faulty state - flashes when timing). In case supply voltage falls below 60 % Un (U<sub>OFF</sub> lower level) relay immediately opens without delay and faulty state is indicated by red LED. In case timing is in progress and faulty state is indicated, timing is immediately stopped.

- It serves to monitor voltage, phase failure and sequence in switchboards, protection of devices in 3-phase mains.
- It is possible to set upper and lower level of monitoring voltage.
- Adjustable time delay eliminates short voltage peaks and failures in the main.
- In case supply voltage falls below 60 % Un (U<sub>OFF</sub> lower level) relay immediately opens without delay.
- **HRN-54:** supply from all phases which means that relay is functional also in case when one phase is faulty.
- **HRN-54N:** supply L1, L2, L3-N, means that relay monitors also failure of neutral wire.

**Description**

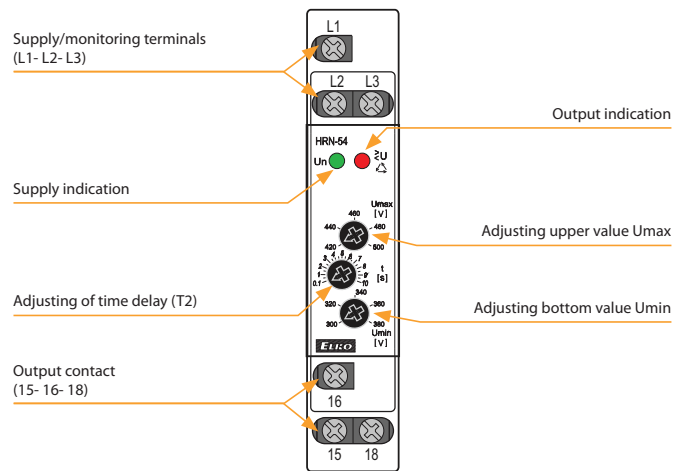

**Function**

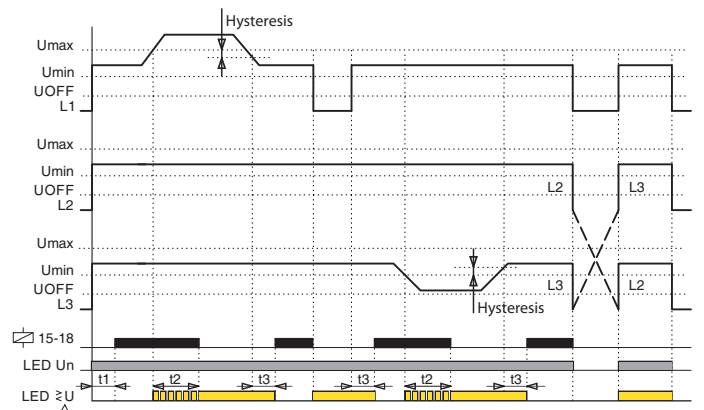

**Connection**

**Symbol**

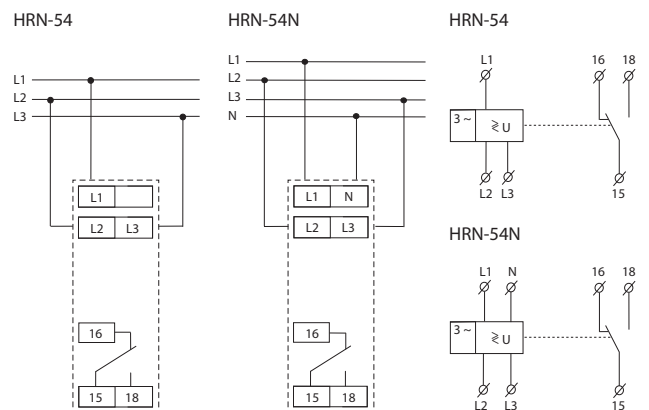





EAN code  
 HRN-56/208V: 8595188130134  
 HRN-56/240V: 8595188137119  
 HRN-56/400V: 8595188137126  
 HRN-56/480V: 8595188130189  
 HRN-56/575V: 8595188130196

### Technical parameters

### HRN-56

	208	240	400	480	575
Supply/monitoring terminals:	L1, L2, L3				
Supply/measured voltage:	3x 208 V L-L (3x120 V L-N) (50-60 Hz)	3x 240 V L-L (3x139 V L-N) (50-60 Hz)	3x 400 V L-L (3x230 V L-N) (50-60 Hz)	3x 480 V L-L (3x277 V L-N) (50-60 Hz)	3x 575 V L-L (3x332 V L-N) (50-60 Hz)
Burden:	max. 2 VA/1 W				
Max. dissipated power	2 W				
( $U_n$ + terminals):					
Level $U_{min}$ :	adjustable 70 - 95 % $U_n$				
Level $U_{off}$ :	60 % $U_n$				
Hysteresis:	2 %				
Max. permanent overload:	AC 3x 276 V	AC 3x 460 V	AC 3x 550 V	AC 3x 660 V	AC 3x 660 V
Peak overload <1s:	AC 3x 300 V	AC 3x 500 V	AC 3x 600 V	AC 3x 700 V	AC 3x 700 V
Time delay t1:	max. 500 ms				
Time delay t2:	adjustable 0 - 10 s				
Time delay t3:	max. 1 s				

### Output

Number of contacts:	1x changeover/SPDT (AgNi/Silver Alloy)	
Current rating:	8 A/AC1; 1/3 HP 240 Vac, 1/4 HP 120 Vac; PD. B300	
Breaking capacity:	2000 VA/AC1, 240 W/DC	
Inrush current:	10 A	
Switching voltage:	250 V AC/24 V DC	
Indication of state:	red LED	
Mechanical life:	60.000.000 ops.	30.000.000 ops.
Electrical life (AC1):	150.000 ops.	200.000 ops.

### Other information

Operating temperature:	-20 .. +55 °C (-4 .. 131 °F)	
Storage temperature:	-30 .. +70 °C (-22 .. 158 °F)	
Dielectrical strength:	4 kV (supply - output)	
Operating position:	any	
Mounting:	DIN rail EN 60715	
Protection degree:	IP40 from front panel/ IP10 terminals	IP40 from front panel/ IP20 terminals
Oversvoltage category:	III.	
Pollution degree:	2	
Max. cable size (mm <sup>2</sup> ):	solid wire max. 2x 2.5 or 1x 4/ with sleeve max. 1x 2.5 or 2x 1.5 (AWG 12)	max. 1x 2.5, max. 2x 1.5/ with sleeve max. 1x 1.5 (AWG 12)
Dimensions:	90 x 17.6 x 64 mm (3.5" x 0.7" x 2.5")	90 x 52 x 65 mm (3.5" x 2" x 2.6")
Weight:	65 g (2.3 oz.)	65 g (2.3 oz.)
Weight:	66 g (2.3 oz.)	110 g (3.9 oz.)
Weight:	110 g (3.9 oz.)	110 g (3.9 oz.)
Standards:	EN 60255-1, EN 60255-26, EN 60255-27	

### Function description

Relay in 3-phase main monitors correct phase sequence and phase failure. Green LED illuminates permanently and indicates energization. In case of phase failure red LED flashes and relay turns off. When changing to faulty state, time delay applies - delay setting is done by potentiometer on the front panel of the device. In case of incorrect phase sequence, red LED shines permanently and relay is open. In case supply voltage falls below 60 %  $U_n$  ( $U_{off}$  lower level), relay immediately opens with no delay and faulty state is indicate by red LED.

**HRN-56:** Thanks to supply from all phases, relay is functional also in case of one phase failure.

- Relay monitors phase sequence and failure (e.g. control of correct motor winding etc.).
- Relay is designated for monitoring of 3-phase networks.
- Supply from all phases which means that relay is functional also in case of one phase failure.
- Supply and monitored supply  $U_n$ :

1-MODULE	3-MODULE
HRN-56/208 - 3x 208 V	HRN-56/480 - 3x 480 V
HRN-56/240 - 3x 240 V	HRN-56/575 - 3x 575 V
HRN-56/400 - 3x 400 V	

- Fixed delay t1 (500 ms), adjustable delay t2 (0.1 - 10 s) and fixed delay t3 (max. 1 s).

### Description

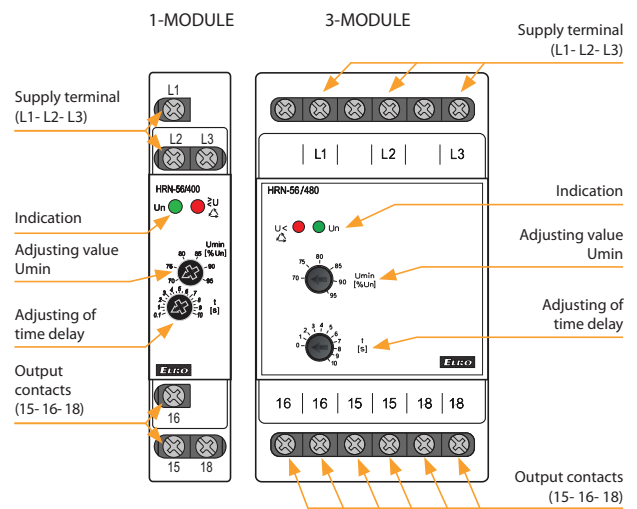

### Function

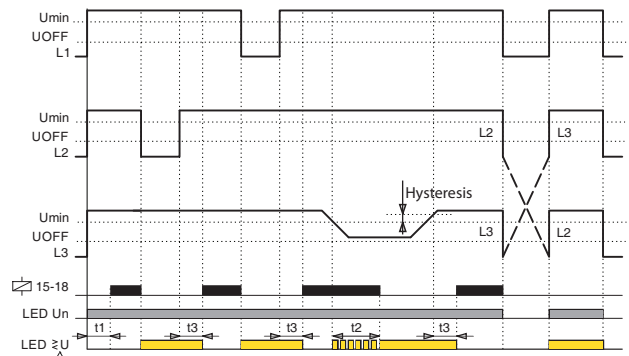

### Connection

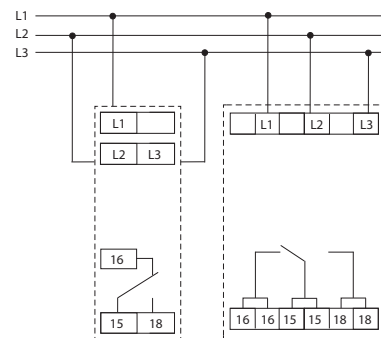

### Symbol

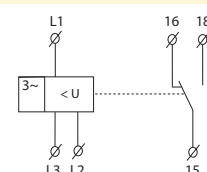



EAN code  
 HRN-43/UNI: 8595188185318  
 HRN-43/400V: 8595188121316  
 HRN-43N/UNI: 8595188185325  
 HRN-43N/400V: 8595188120258

Technical parameters	HRN-43	HRN-43N
<b>Supply</b>		
Supply terminals:	A1-A2	
Supply voltage:	UNI	AC/DC 24 – 240 V (AC 50-60 Hz)
Consumption (max.):	3 VA/1 W	
Supply voltage:	400V	AC 400 V (50-60 Hz)
Consumption (max.):	5 VA/2.5 W	
Supply voltage tolerance:	-15 %; +10 %	
<b>Measuring circuit</b>		
Monitored terminals:	L1-L2-L3	L1-L2-L3-N
Voltage system:	3x 400 V (50-60 Hz)	3x 400 V/230 V (50-60 Hz)
Upper level setting (Umax):	240 – 480 V	138 – 276 V
Lower level setting (Umin):	35 – 99 %Umax	
Max. permanent voltage:	3x 480 V	
Asymmetry:	adjustable, 5 – 20 % + OFF	
Peak overload (1 s):	600 V	350 V
Time delay (t1):	fixed, max. 200 ms	
Time delay Umax/Umin (t2):	adjustable, 0.1 – 10 s	
<b>Accuracy</b>		
Setting accuracy (mech.):	5 %	
Repeat accuracy:	< 1 %	
Temperature dependence:	< 0.1 %/°C (°F)	
Limit values tolerance:	5 %	
Hysteresis (fault to OK):	selectable, 5 %/10 % from the upper range value	
<b>Output</b>		
Contact type:	2x changeover/SPDT (AgNi)	
Current rating:	16 A/AC1; 1 HP 240 Vac, 1/2 HP 120 Vac; PD. B300	
Breaking capacity:	4000 VA/AC1, 384 W/DC1	
Inrush current:	30 A/< 3 s	
Switching voltage:	250 V AC/24 V DC	
Power dissipation (max.):	2.4 W	
Mechanical life:	10.000.000 ops.	
Electrical life (AC1):	100.000 ops.	
<b>Other information</b>		
Operating temperature:	-20 .. 55 °C (-4 .. 131 °F)	
Storage temperature:	-30 .. 70 °C (-22 .. 158 °F)	
Dielectric strength:		
supply – output	AC 4 kV	
output 1 – output 2	AC 4 kV	
Operating position:	any	
Mounting:	DIN rail EN 60715	
Protection degree:	IP40 front panel / IP20 terminals	
Overvoltage category:	III.	
Pollution degree:	2	
Cross-wire section – solid/ stranded with ferrule (mm2):	max. 1x 2.5, 2x 1.5/ max. 1x 2.5 (AWG 14)	
Dimensions:	90 x 52 x 65 mm (3.5" x 2" x 2.6")	
Weight:	UNI – 148 g (5.2 oz), 400V – 248 g (8.7 oz)	
Standards:	EN 60255-1, EN 60255-26, EN 60255-27	

- Relay is designed to monitor voltage in 3-phase networks:
  - HRN-43:** delta connection 3x 400 V (without neutral)
  - HRN-43N:** star connection 3x 400/230 V (with neutral)
- Monitors level of voltage in two independent levels (Umax, Umin) overvoltage and undervoltage:
  - system 3x 400 V: range 240 – 480 V
  - system 3x 400/230 V: range 138 – 276 V
- Other monitored parameters:
  - phase failure, sequence, asymmetry (adjustable, can be switched off)
- Setting the monitored lower level (Umin) in % of the set upper level Umax.
- Adjustable time delay (eliminating short-term drops and spikes).
- Selectable function of output contacts (independently/in parallel).
- Galvanically separated supply voltage AC/DC 24 – 240 V, AC 400 V.
- Output contact for each monitored voltage level.

### Description

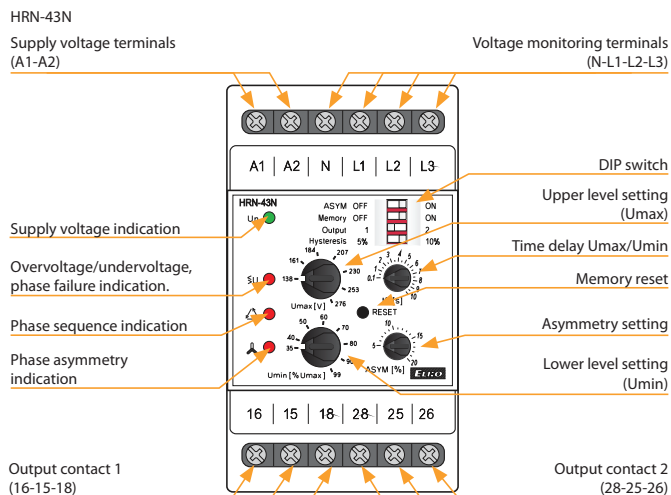

### Description of DIP switch

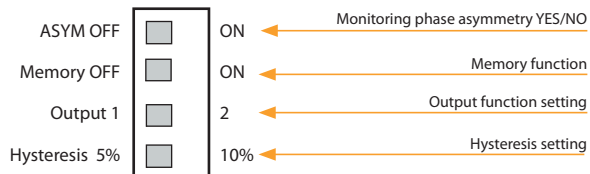

### Connection

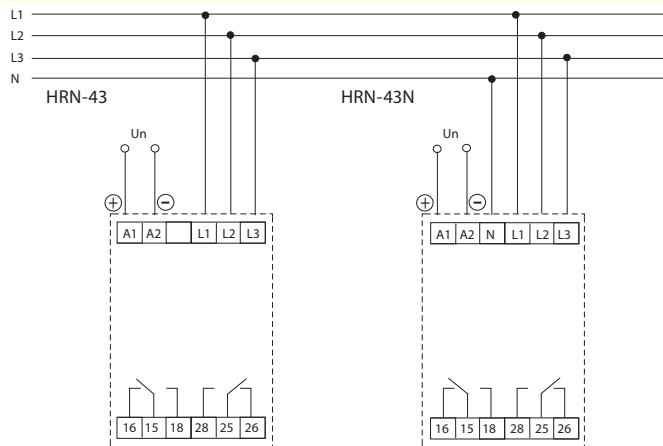

### Symbol

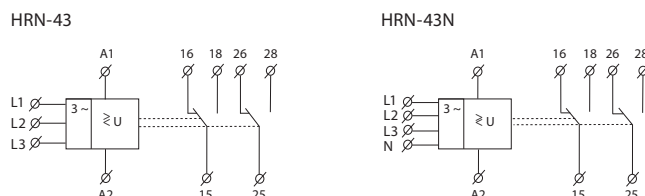

## Function

## Overvoltage - undervoltage

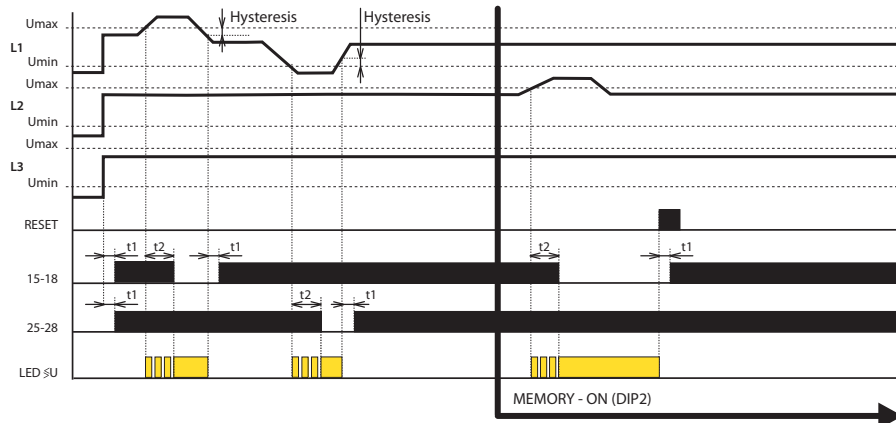

## Graphs legend:

L1, L2, L3 = 3-phase voltage  
 RESET = memory reset  
 t1 = time delay, fixed  
 t2 = time delay Umax/Umin, adjustable  
 15-18 = output contact 1  
 25-28 = output contact 2  
 LED  $\leq U$  = overvoltage/undervoltage indication

## Function of output contacts:

In order to monitor two levels of voltage, it is possible to select if output contact will respond to each level individually (see the diagram) or both contacts will switch in parallel (see diagram "phase sequence").

Selection via DIP switch „Output“.

## Phase sequence

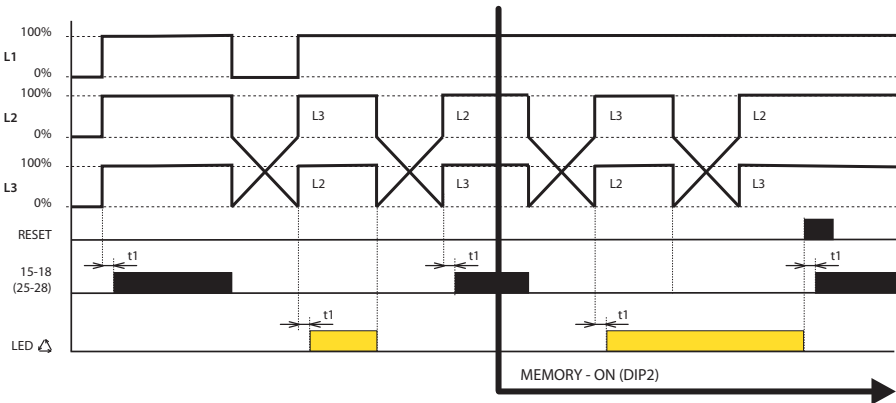

## Graphs legend:

L1, L2, L3 = 3-phase voltage  
 RESET = memory reset  
 t1 = time delay, fixed  
 t2 = time delay Umax/Umin, adjustable  
 15-18 = output contact 1  
 25-28 = output contact 2  
 LED  $\Delta$  = phase sequence indication

## Function of output contacts:

The function is not applicable in the phase sequence monitoring, the contacts are switched in parallel.

DIP switch „Output“ is ignored.

## Phase asymmetry - failure

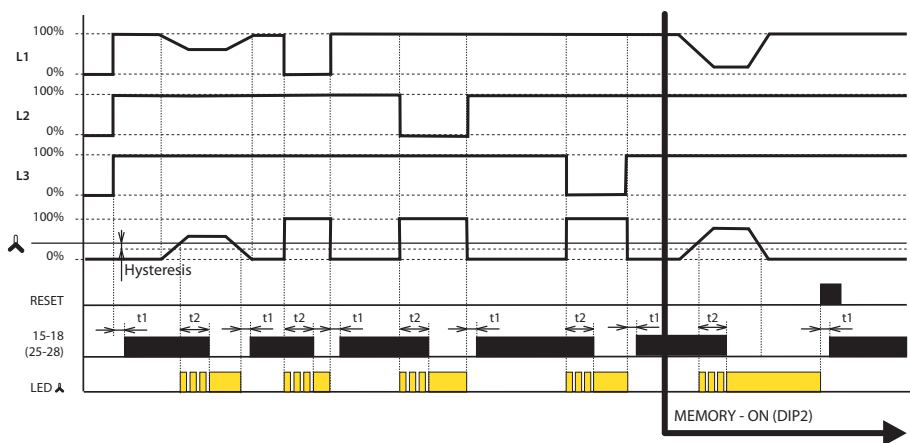

## Graphs legend:

L1, L2, L3 = 3-phase voltage  
 RESET = memory reset  
 t1 = time delay, fixed  
 t2 = time delay Umax/Umin, adjustable  
 $\blacktriangle$  - adjustable asymmetry level  
 15-18 = output contact 1  
 25-28 = output contact 2  
 LED  $\blacktriangle$  - asymmetry indication

## Function of output contacts:

The function is not applicable in the phase asymmetry and failure monitoring, the contacts are switched in parallel way.

DIP switch „Output“ is ignored.

Relay is designated to monitor 3-phase circuits. Type HRN-43 controls the interphase voltage, type HRN-43N controls voltage towards the neutral wire. Relay can monitor: voltage in two levels (overvoltage/undervoltage), phase sequence/failure and asymmetry. Each fault state is indicated by an individual LED. By DIP switch „Output“ it is possible to select the function of output contacts: independent function (1x for overvoltage, 1x for undervoltage) or in parallel. Fixed time delay (t1) is applied when changing from fault to OK state or when de-energized. Adjustable time delay (t2) is applied, when changing from OK to fault state. This delay prevents incorrect behavior and oscillation of the output device during short-term voltage drops and peaks.

## Voltage monitoring

The upper level Umax is set in the range 138 – 276 V (resp. 240 – 480 V for HRN-43) and the lower level Umin in the range of 35 – 99 %Umax. In case any phase deviates from this set band, after a set delay, output contact opens. Output contact again closes after returning back into the monitored band and exceeding fixed hysteresis (selectable by DIP switch „Hysteresis“). In the event of an outage in two or three phases, the output contacts will open immediately, regardless of the set delay t2.

## Phase sequence

Monitors correctness of phase sequence. In case of unwanted change, output contacts open. In case of energization of a relay with incorrect phase sequence, contacts stay open.

## Asymmetry

The level of asymmetry between individual phases is set in the range of 5 – 20 %. In case set asymmetry is exceeded, output contacts open and LED indicating asymmetry shines. Time delays t1, t2 and hysteresis are applied when returning to OK state. Monitoring asymmetry can be switched off by the DIP switch „ASYM“.



EAN code  
 HRN3-70: 8595188188838  
 PMR3-70: 8595188185288

- It is used for monitoring of voltage, phase failure, sequence and asymmetry in 3-phase network.
- Wide range of monitored voltage with automatic selection of a low/high range.
- Fixed overvoltage level (U<sub>max</sub>), adjustable undervoltage level (U<sub>min</sub>).
- Adjustable time delay t<sub>2</sub> (to eliminate short-term voltage drops and peaks).
- Adjustable time delay t<sub>3</sub> (to eliminate short-term OK state).
- Adjustable asymmetry level with option to turn it OFF.
- Measures true root mean square value of the voltage - TRUE RMS.
- Fault memory reset can be done by RESET button on the panel or by an external opening contact.

Technical parameters	HRN3-70	PMR3-70
Supply/monitored terminals:	L1-L2-L3	3-4-5
Supply/monitored voltage:	AC 3× 190 – 500 V (50-60 Hz)	
Consumption (max.):	2 VA/1 W	
Upper level (U <sub>max</sub> ):	110 %Un	
Lower level (U <sub>min</sub> ):	80 – 95 %Un	
Asymmetry:	adjustable, 2 – 10 %Un + OFF	
Max. permanent voltage:	AC 3× 550 V	
Peak overload (1 s):	AC 3× 600 V	
Time delay (t <sub>1</sub> ):	2 s	
Time delay (t <sub>2</sub> ):	adjustable, 0.3 – 30 s	
Time delay (t <sub>3</sub> ):	adjustable, 1 – 300 s	
<b>Accuracy:</b>		
Hysteresis (fault to OK):	5 %	
<b>Output</b>		
Contact type:	2x changeover (AgNi)	1x changeover (AgNi)
Current rating:	16 A/AC1; 1 HP 240 Vac, 1/2 HP 120 Vac; PD. B300	
Breaking capacity:	4000 A/AC1, 384 W/DC1	
Switching voltage:	250 V AC/24 V DC	
Power dissipation (max.):	2.4 W	1.2 W
Mechanical life:	10.000.000 ops.	
Electrical life (AC1):	100.000 ops.	
<b>Other information</b>		
Operating temperature:	–20 .. 55 °C (–4 .. 131 °F)	
Storage temperature:	–30 .. 70 °C (–22 .. 158 °F)	
Dielectric strength:		
supply – output 1	AC 4 kV	AC 2.5 kV
supply – output 2	AC 4 kV	-
output 1 – output 2	AC 4 kV	-
Operating position:	any	
Mounting:	DIN rail EN 60715	into socket (8-pin)
Protection degree:	IP40 front panel/IP20 terminals	IP40
Overvoltage category:	III.	
Pollution degree:	2	
Cross-wire section – solid/stranded with ferrule (mm <sup>2</sup> ):	max. 1× 2.5, 2× 1.5/ max. 1× 2.5 (AWG 14)	max. 1× 4, 2× 2.5/ max. 1× 4 (AWG 12)
Dimensions:	90 × 52 × 66 mm	48 × 48 × 79 mm
Weight:	140 g (4.94 oz)	100 g (3.53 oz)
Standards:	EN 60255-1, EN 60255-26, EN 60255-27	

**Range switch (Un)**

The range switch has two ranges of phase-to-phase voltage values:  
 low (190 to 250V) and high (380 to 500V)  
 After connecting to the supply/monitored voltage, the device evaluates voltage size and selects the corresponding range of values. When switching between individual positions within the selected range, the green „LED Un“ will flash briefly.

**Description**

**HRN3-70**

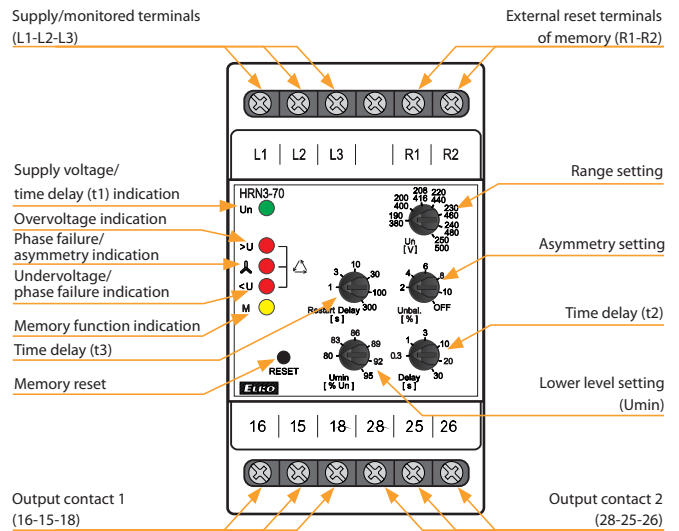

**Connection**

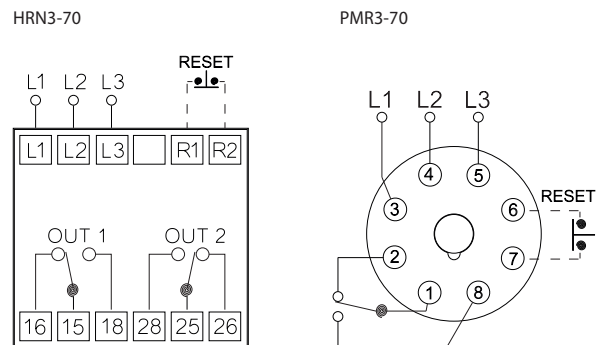

## Function

## Overvoltage - undervoltage

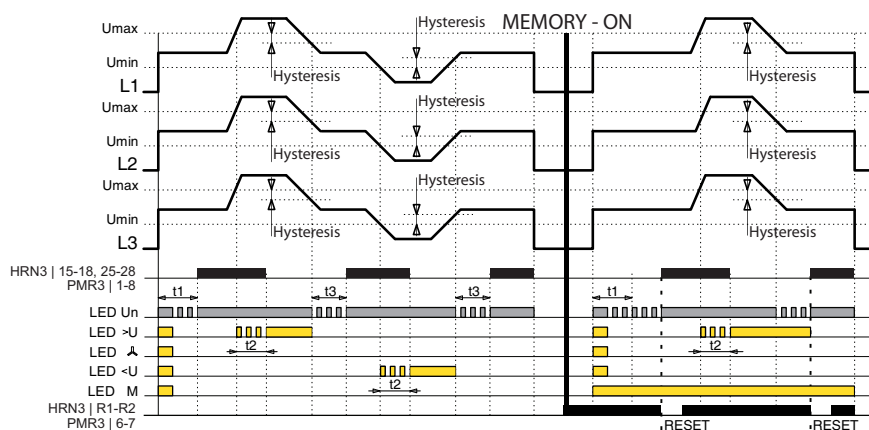

## Graphs legend:

L1, L2, L3 = 3-phase voltage  
 RESET = memory reset  
 t1 = time delay, after connecting to voltage  
 t2 = time delay into fault state  
 t3 = time delay to OK state  
 15-18 = output contact 1 (HRN3)  
 25-28 = output contact 2 (HRN3)  
 1-8 = output contact (PMR3)  
 LED >U = overvoltage indication  
 LED <U = undervoltage/phase failure indication  
 LED A = phase failure/asymmetry indication  
 LED M = memory function indication  
 LED Un = supply/monitored voltage, time delay t1 and t2 indication

## Phase asymmetry - failure

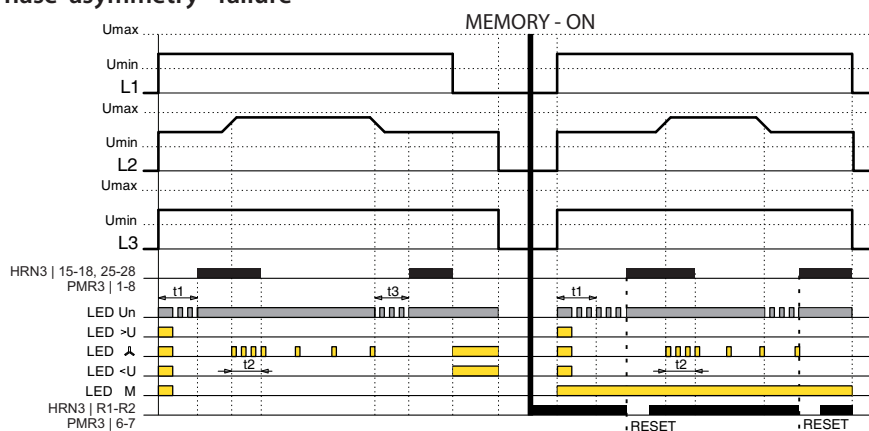

## Phase sequence

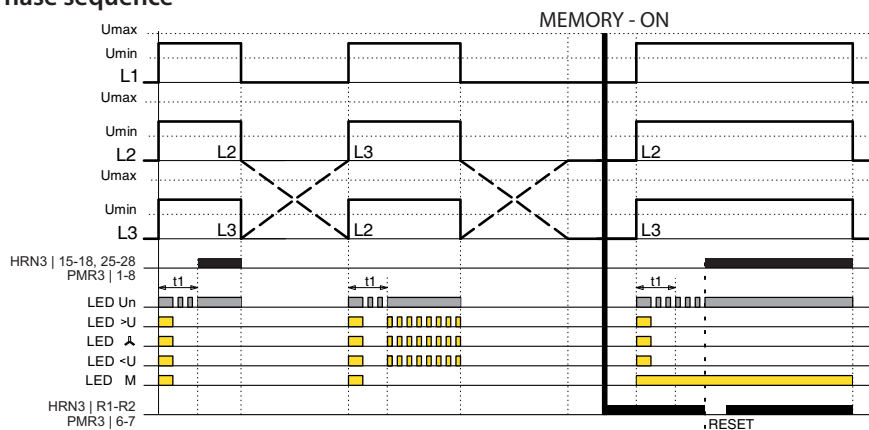

After connecting the device to the supply voltage, all the LEDs on the panel will flash briefly.

If a 3-phase voltage is connected to the monitoring relay and all conditions are met (correct voltage magnitude, sequence and phase asymmetry), the output contacts close after the time delay t1 has elapsed. During the time delay, the green „LED Un“ flashes, after the end of the delay it lights up permanently (OK state).

- When the voltage exceeds or falls outside the „Umin“ and „Umax“ levels, after the time delay t2 the green and the corresponding red „LED <“ light up.

The output contacts are open (fault state). During the time delay, the red LED flashes.

- If the phase sequence is incorrect when the power is connected, after the time delay t1 the green „LED Un“ lights up + all 3 red „LEDs <“ flash simultaneously.

The output contact is open (fault state). During the time delay, the green LED flashes.

- When the set phase asymmetry is exceeded, after the time delay t2 the green „LED Un“ lights up and the red „LED A“ flashes briefly.

The output contact is open (fault state). During the time delay, the red LED flashes rapidly.

- In the event of a phase failure, the output contacts open without a time delay t2 (fault state), the green „LED Un“ and the corresponding red „LED <“ light up.

- To return from the fault state to the OK state, the time delay t3 is always applied. During this time delay, the green „LED Un“ flashes.

**Reset and fault state memory activation:**

By connecting terminals R1-R2 or pins 6-7 in the PLUG-IN version via an external push button with a break contact (RESET), the fault state memory is activated. After turning on the power, the yellow „LED M“ on the device panel lights up. If a fault condition occurs, it is stored in memory. The red LED signalize fault just like in mode with fault state memory turned off. If the voltage values return to the set levels, the corresponding red LED will be permanently lit and at the same time the green „LED Un“ will start flashing. It is now possible to reset fault memory state, this closes the output contact and the red LED goes out (OK state). Fault memory reset (RESET) is performed either with an external pushbutton or with the pushbutton on device panel.





EAN code  
 HRN3-80: 8595188188814  
 HRN3-81: 8595188188821

Technical parameters	HRN3-80	HRN3-81
<b>Supply and measuring</b>		
Supply/monitored terminals:	L1-L2-L3	
Supply/monitored voltage:	AC 3× 208 – 480 V (50-60 Hz)	
Consumption (max.):	2 VA/1 W	
Range setting:	adjustable	fixed
Lower level setting (Umin):	80 – 95 %Un	x
Asymmetry setting:	adjustable, 2 – 10 %Un + OFF	
Max. permanent voltage:	AC 3× 550 V	
Peak overload (1 s):	AC 3× 600 V	
Time delay (t1):	2 s	
Time delay (t2):	adjustable, 0.3 – 30 s	
<b>Accuracy</b>		
Setting accuracy (mech.):	5 %	
Repeat accuracy:	< 1 %	
Temperature dependency:	< 0.1 %/°C (°F)	
Hysteresis (fault to OK):	5 %	
<b>Output</b>		
Contact type:	1x changeover/SPDT (AgNi)	
Current rating:	16 A/AC1; 1 HP 240 Vac, 1/2 HP 120 Vac; PD. B300	
Breaking capacity:	4000 A/AC1, 384 W/DC1	
Switching voltage:	250 V AC/24 V DC	
Power dissipation (max.):	1.2 W	
Mechanical life:	10.000.000 ops.	
Electrical life (AC1):	100.000 ops.	
<b>Other information</b>		
Operating temperature:	–20 .. 55 °C (–4 .. 131 °F)	
Storage temperature:	–30 .. 70 °C (–22 .. 158 °F)	
Dielectric strength:	AC 4 kV (supply – output)	
Operating position:	any	
Mounting:	DIN rail EN 60715	
Protection degree:	IP40 front panel / IP20 terminals	
Overtoltage category:	III.	
Pollution degree:	2	
Cross-wire section – solid/ stranded with ferrule (mm²):	max. 1× 2.5, 2× 1.5/ max. 1× 2.5 (AWG 14)	
Dimensions:	90 × 52 × 66 mm	
Weight:	66 g (2.32 oz)	64 g (2.26 oz)
Standards:	EN 60255-1, EN 60255-26, EN 60255-27	

- The relay is designed to monitor undervoltage (HRN3-80), phase loss, sequence and asymmetry in 3-phase network.
- Power supply from monitored circuit.
- **HRN3-80:** Monitors the drop below the lower voltage level (Umin).
- **HRN3-80:** The lower level of Umin is set in % of the selected range.
- Wide range of monitored voltage 208 – 480 V.
- Adjustable time delay (to eliminate short-term voltage drops).
- Measures true root mean square value of the voltage - TRUE RMS.
- Adjustable level of asymmetry with the option to turn it off.

**Description**

HRN3-80

Supply/monitored voltage terminals (L1-L2-L3)

Supply voltage/ time delay (t1) indication

Indication of operating states

HRN3-80: Range setting

HRN3-80: Lower level setting (Umin)

Time delay (t2)

Asymmetry setting

Output contact (15-16-18)

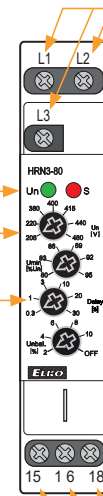

**Connection**

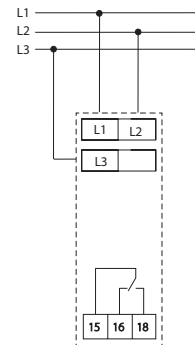

**Symbol**

HRN3-80

HRN3-81

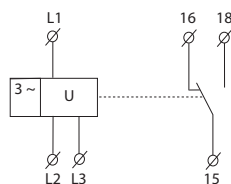
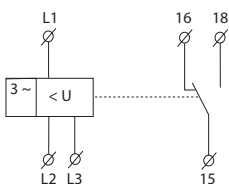



Function

Undervoltage:

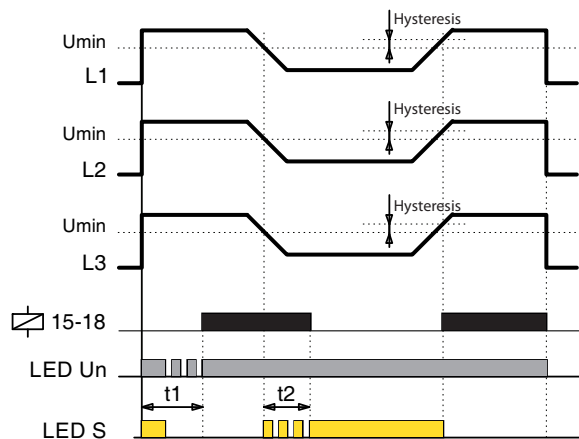

After connecting the device to the supply voltage, both LEDs on the panel will flash briefly.

If 3-phase voltage is connected to the monitoring relay and all conditions are met (correct voltage level, phase sequence and asymmetry), the output contact closes after the time delay  $t_1$  elapsed.

During the time delay, the green „LED Un“ flashes, at the end of the delay „LED Un“ lights up continuously (OK state).

When the voltage drops below the lower level „Umin“ (HRN3-80 only), after the time delay  $t_2$  has elapsed the green and red LEDs are lit. The output contact is open (fault state).

During the time delay  $t_2$ , the red „LED S“ flashes quickly.

If the phase sequence is incorrect when the power supply is connected, after the time delay  $t_1$  has elapsed the green and red LED flashes quickly. The output contact is open (fault state).

During the time delay  $t_1$ , the green „LED Un“ flashes.

Phase sequence:

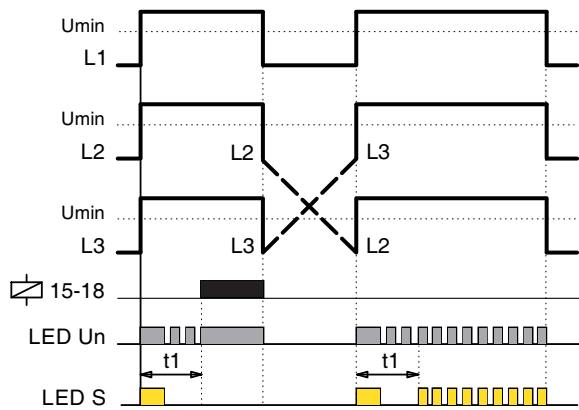

When the set phase asymmetry is exceeded, after the time delay  $t_2$  has elapsed the green LED is lit and the red LED flashes briefly. The output contact is open (fault state).

During the time delay  $t_2$ , the red „LED S“ flashes quickly.

In the event of phase failure, the output contact opens without a time delay  $t_2$  (fault state), the green and red LEDs are lit.

The return from the fault state to the OK state occurs without a time delay.

Phase asymmetry, failure:

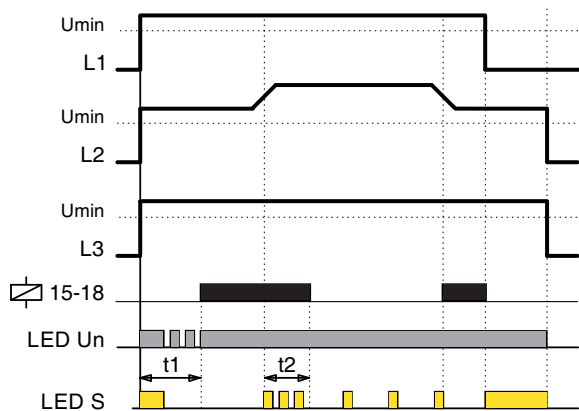



EAN code  
HRN-100: 8595188171229

**Technical parameters** **HRN-100**

**Supply**

Supply and measuring terminals:	L1, L2, L3, (N)
Supply and monitored voltage:	$U_{LN} = 3 \sim 90 - 288 \text{ V, (AC 45-65 Hz)}$ $U_{LL} = 3 \sim 155 - 500 \text{ V, (AC 45-65 Hz)}$
Power consumption (max.):	5 VA

**Measuring circuit**

Selection of the measured circuit:	Phase voltage - 3 phase, 4 wire Line voltage - 3 phase, 3 wire
Adjustable upper (OV) and lower (UV) voltage levels:	Phase voltage: 90 - 288 VAC Line voltage: 155 - 500 VAC
Upper (HC) / lower (LC) limit voltage:	Phase voltage: 310 VAC / 85 VAC Line voltage: 535 VAC / 150 VA
Adjustable upper (OF) and lower (UF) frequency level:	45 - 65 Hz
Adjustable asymmetry:	Absolute: 5 - 99 VAC Percentage: 2 - 50%
Adjustable voltage and frequency hysteresis level:	3 - 20 VAC (OV,UV, HC, LC) 0.5 - 2 Hz (OF, UF)
Adjustable hysteresis asymmetry:	Absolute: 3 - 99 VAC Percentage: 2 - 15%
Accuracy of measured voltage:	+/- 5V
Accuracy of measured frequency:	+/- 0.3 Hz
Adjustable delay after supply connection $P_{on}$ :	(HW initialization 250 ms)
Adjustable delay $T_{on}$ :	0.5 - 999 s
Adjustable delay $T_{off}$ :	0.1 - 999 s
Fixed delay:	<100 ms (phase sequence, failure) <200 ms (HC, LC), <500 ms (neutral fail)

**Output**

Output contact:	2x changeover (AgSnO <sub>2</sub> )
Rated current:	5A/AC1
Switching power:	1200VA/AC1, 150W/DC1
Switching voltage:	240V AC/30V DC
Max. output power dissipation:	5W
Mechanical life:	10.000.000 ops.
Electrical life (AC1):	100.000 ops

**Other information**

Operating temperature:	-10 .. +60 °C (14 .. 140 °F)
Storage temperature:	-20 .. +70 °C (-4 .. 158 °F)
Dielectric strength:	4kV (supply - output)
Operating position:	any
Mounting:	DIN rail EN 60715
Protection degree:	IP20 terminals/IP40 from front panel
Overtoltage category:	III.
Pollution degree:	2
Cable size (mm <sup>2</sup> ):	max. 1x 2.5, max. 2x 1.5/ with sleeve max. 1x 2.5
Dimensions:	90 x 36 x 66,5 mm (3.6" x 1.5" x 2.7")
Weight:	132 g (4.7 oz.)
Standards:	EN 61812-1, EN IEC 63044

- 3-wire or 4-wire connection (with or without neutral).
- Optionally monitors upper and lower voltage & frequency in 3-phase circuits.
- Allows monitoring of phase sequence, failure and asymmetry incl. neutral fail (only in 4-wire connection).
- The device is supplied from monitored voltage.
- Both output contacts can be set individually.
- Measures real effective value of AC voltage (True RMS).
- Optional response delay of the output contact to the measured fault state or transition from the fault state to the OK state incl. delayed response of output contacts after connecting the power supply.
- Possibility of automatic or manual transition from fault state (memory).
- Optional closing or opening of the output contact when measuring a fault state (Fail Safe / Non Fail Safe).
- Password protection against unauthorized changes to settings.
- Digital backlit display with the possibility of monitoring the current state of the network, incl. possible failures.
- The last five fault states are stored in a history that can be viewed retrospectively.
- Sealable transparent cover for display and controls.

**Description**

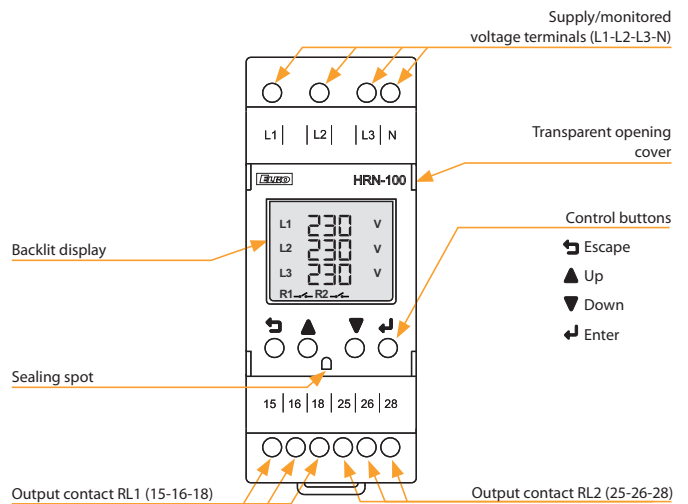

**Description of display elements on the screen**

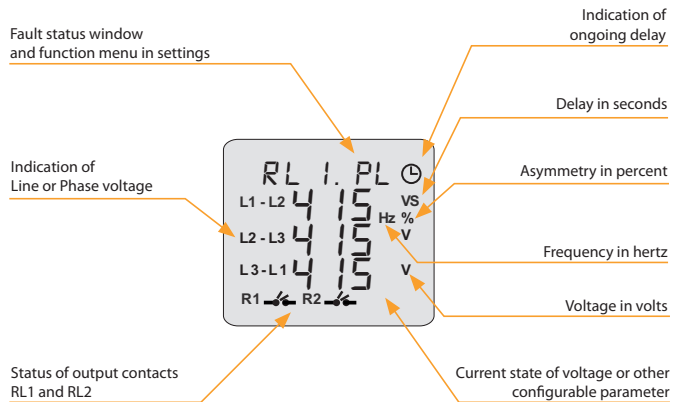

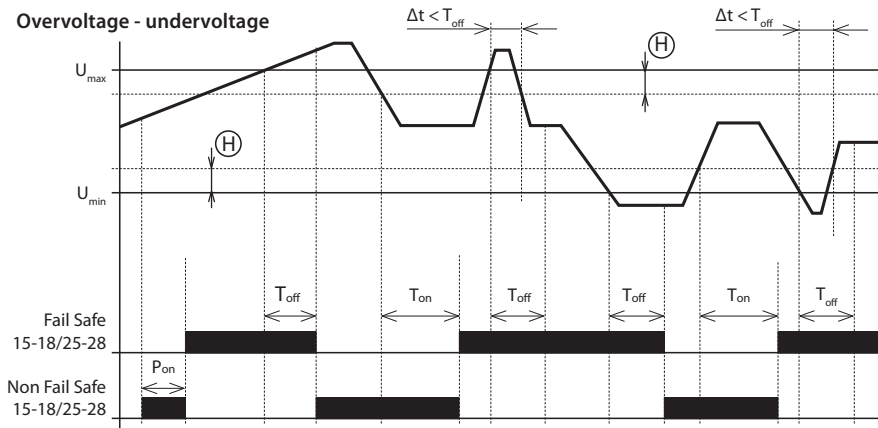

**Graph legend:**  
 P<sub>on</sub> - Power ON delay (delay after power supply connection)  
 P<sub>on</sub> = 0 - 999 s (min. 250 ms hardware initialization)  
 T<sub>on</sub> - ON Delay (delay to OK state)  
 T<sub>on</sub> = 0,5 - 999 s  
 T<sub>off</sub> - OFF delay (delay to fault state)  
 T<sub>off</sub> = 0,1 - 999 s  
 T<sub>off</sub> - Adjustable for OV, UV, OF, UF & asymmetry faults  
 T<sub>off</sub> - Phase sequence, failure <100ms;  
 Neutral fail <500ms  
 Δt - Duration of the fault state  
 (H) Hysteresis

- After the supply/monitored voltage is connected, the delay P<sub>on</sub> starts timing - during the timing the output contact is in a fault state - in the FAIL SAFE mode it is open. After the delay, if the monitored voltage is in the range U<sub>min</sub> ... U<sub>max</sub>, the output contact closes.
- If the monitored voltage exceeds the set value U<sub>max</sub>, the time delay to the fault state (T<sub>off</sub>) starts. After the delay, the output contact opens.
- If the monitored voltage falls below the U<sub>max</sub> value reduced by the set hysteresis, the time delay start to OK state (T<sub>on</sub>). After the delay, the output contact closes.
- If the duration of the fault state (Δt) is shorter than the set value T<sub>off</sub>, the status of the output contact does not change.
- If the monitored voltage falls below the value U<sub>min</sub>, the time delay to the fault state (T<sub>off</sub>) starts. After the delay, the output contact opens.
- If the monitored voltage exceeds the value U<sub>min</sub> increased by the set hysteresis, the time delay start to the OK state (T<sub>on</sub>). After the delay, the output contact closes.
- If the duration of the fault state (Δt) is shorter than the set value (T<sub>off</sub>), the status of the output contact does not change.

**Phase sequence**

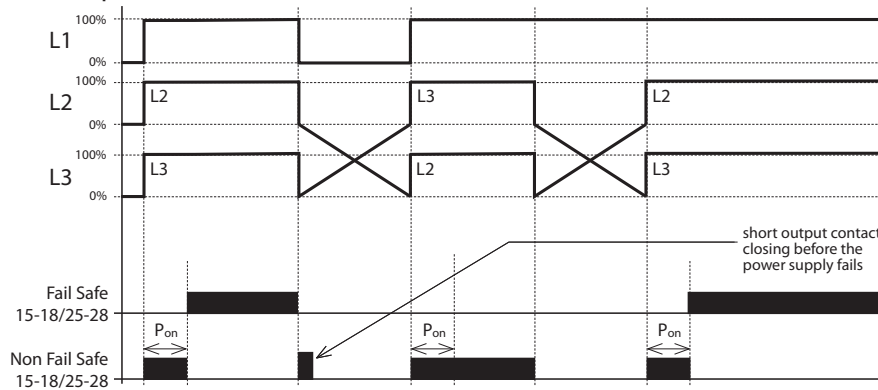

**Graph legend:**  
 P<sub>on</sub> - Power ON delay (delay after power supply connection)  
 P<sub>on</sub> = 0 - 999 s (min. 250 ms hardware initialization)

- After the supply/monitored voltage is connected, the delay P<sub>on</sub> starts timing - during the timing the output contact is in a fault state - in FAIL SAFE mode it is open. After the delay, if the phase sequence is correct, the output contact closes.
- If the phase sequence is incorrect after the P<sub>on</sub> delay, the output contact remains open (fault state).

**Asymmetry, phase failure**

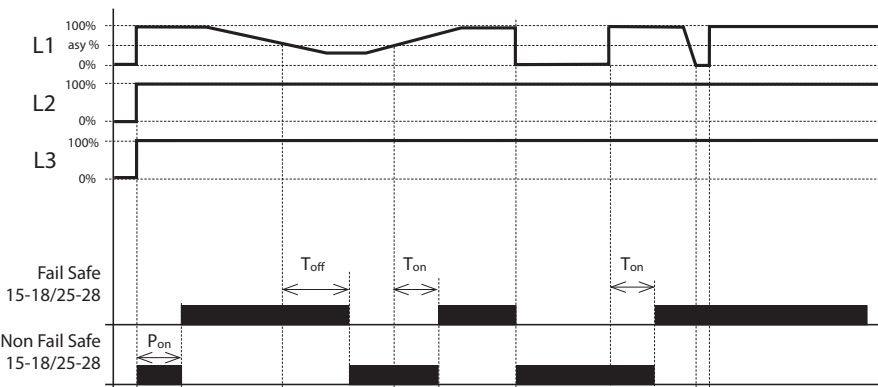

**Graph legend:**  
 P<sub>on</sub> - Power ON delay (delay after power supply connection)  
 P<sub>on</sub> = 0 - 999 s (min. 250 ms hardware initialization)  
 T<sub>on</sub> - ON Delay (delay to OK state)  
 T<sub>on</sub> = 0,5 - 999 s  
 T<sub>off</sub> - OFF delay (delay to fault state)  
 T<sub>off</sub> = 0,1 - 999 s  
 T<sub>off</sub> - Adjustable for OV, UV, OF, UF & asymmetry faults  
 T<sub>off</sub> - Phase sequence, failure <100ms;  
 Neutral fail <500ms  
 Δt - Duration of the fault state

- After the supply/monitored voltage is connected, the delay P<sub>on</sub> starts timing - during the timing the output contact is in a fault state - in the FAIL SAFE mode it is open. After the delay, if the phase asymmetry is lower than the set value (absolute or percentage), the output contact closes.
- If the phase asymmetry exceeds the set value, the time delay to the fault state (T<sub>off</sub>) begins. After the delay, the output contact opens.
- If the phase asymmetry falls below the set value, the time delay starts to OK state (T<sub>on</sub>). After the delay, the output contact closes.
- If the duration of the fault state (Δt) is shorter than the set value T<sub>off</sub>, the status of the output contact does not change.
- If a phase failure occurs, the time delay to the fault state (T<sub>off</sub>) begins. After the delay, the output contact opens.
- If the phase failure resumes, the time delay starts to OK state (T<sub>on</sub>). After the delay, the output contact closes.
- If the duration of the fault state (Δt) is shorter than the set value T<sub>off</sub>, the status of the output contact does not change.

Connection

3-wire connection

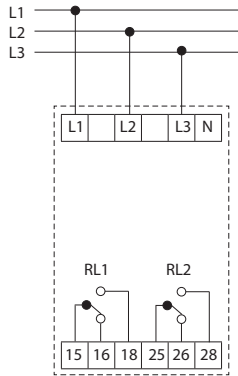

4-wire connection

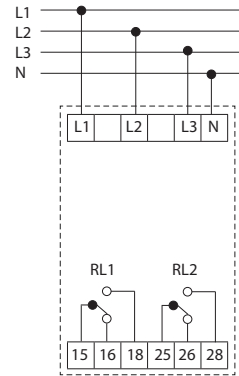

Description of controls and signaling

Relay contact mode

Mode	OK state	Fault state
Fail Safe	15 & 25 (Pole)  18 & 28 (NO)	15 & 25 (Pole)  18 & 28 (NO)
Non Fail Safe	15 & 25 (Pole)  18 & 28 (NO)	15 & 25 (Pole)  18 & 28 (NO)

Fault status window

Short-cut	Meaning
"FLT.NF"	Neutral fail
"FLT.LC"	Lower threshold voltage
"FLT.HC"	Upper threshold voltage
"RLx.PL"	Phase failure
"RLx.PR"	Phase sequence
"RLx.ASY"	Phase asymmetry
"RLx.OF"	Overfrequency
"RLx.UF"	Underfrequency
"RLx.OV"	Overvoltage
"RLx.UV"	Undervoltage

Note: RLx indicate RL1 & RL2

Control buttons

Escape		Enter the settings menu (long press >1 s). Return to the main screen or previous menu in edit or display mode. Step back when changing a value or parameter.
Up		Move parameters up. Change/increase the value of a parameter in edit mode. Selection of the currently measured parameter on the main screen - voltage, frequency, asymmetry (pressing the button <500 ms).
Down		Moving parameters down. Change/decrease the value of a parameter in edit mode. Display history of fault states (pressing the button <500 ms).
Enter		Select and save a parameter value in edit mode. Resetting the product from memory mode (long press >1 s).
Escape Enter	 	Press a key combination to display the read-only settings menu (long press >1 s).



EAN code  
MPS-1: 8595188145978

Technical parameters		MPS-1
Supply voltage:	AC 3x 400/230 V (50-60 Hz)	
Supply voltage tolerance:	+20 %; -75 %	
Power consumption:	max. 1 VA/0.5 W	
<b>Indication</b>		
LED not illuminated:	0 to 50 V/45 to 0 V	
LED illuminated		
yellow:	50 to 207 V/195.5 to 45 V	
green:	207 to 264.5 V/253 to 195.5 V	
red:	264.5 to 276 V/276 to 253 V	
<b>Other information</b>		
Design:	1 MODULE	
Mounting:	DIN rail EN60715	
Operating position:	any	
Coverage:	panel IP40, terminals IP10	
Overvoltage category:	III.	
Contamination level:	2	
Max. cable size (mm <sup>2</sup> ):	solid wire max. 2x 2.5 or 1x 4/ with sleeve max. 1x 2.5 or 2x 1.5 (AWG 12)	
Working temperature:	-20 .. 55 °C (-4 .. 131 °F)	
Storage temperature:	-30 .. 70 °C (-22 .. 158 °F)	
Dimensions:	90 x 17.6 x 64 mm (3.5" x 0.7" x 2.5")	
Weight:	48 g (1.7 oz.)	
Standards:	EN 60947-1, EN 60947-5-1	

- Used for optical signaling of the voltage level in 3-phases.
- Each phase features LED signaling broken is divided by color into voltage levels:
  - voltage in tolerance of  $\pm 15\%$  - green
  - overvoltage - red
  - undervoltage - yellow
  - voltage < 50 V - LED not illuminated.
- 4-wire connection - L1, L2, L3, N.
- Monitors phase voltages against neutral wire.
- Not dependent upon order of phases.

### Description of device

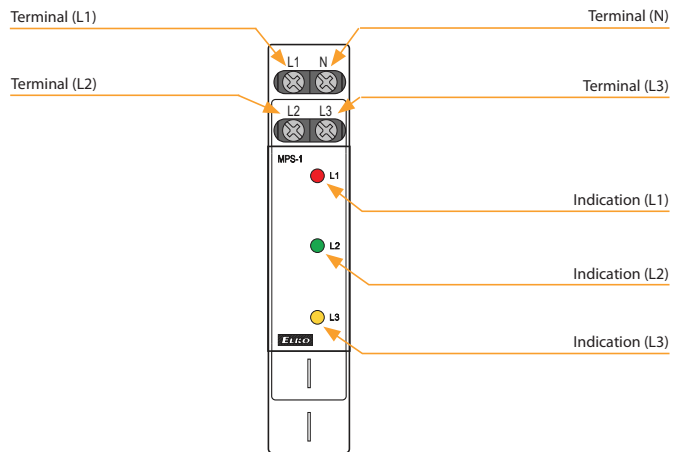

### Function

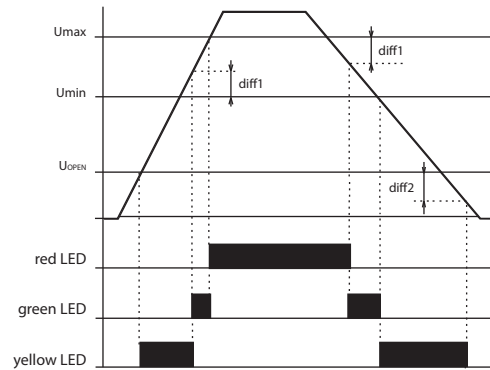

After connecting the supply voltage, the LED illuminates - the color corresponds to the voltage size of individual phases. If the phase voltage drops under 45 V (phase outage), the corresponding LED is not illuminated.

### Connection

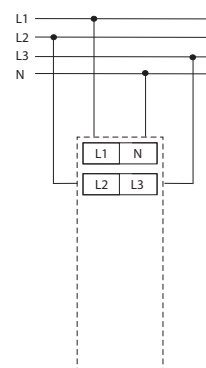



EAN code  
 COS-2/230V: 8595188155434  
 COS-2/110V: 8595188152280  
 COS-2/400V: 8595188152365  
 COS-2/24V: 8595188155441

**Technical parameters** **COS-2**

**Supply**

Supply terminals:	A1 - A2
Voltage range:	AC 230 V, AC 110 V, AC 400 V or AC/DC 24 V (AC 50-60 Hz)
Burden max.:	2.5 W/5 VA (AC 110 V, AC 230 V, AC 400 V), 1.4 W/2 VA (AC/DC 24 V)
Max. dissipated power (Un + terminals):	4 W
Operating range:	-15 %; +10 %

**Measuring**

Voltage set:	3x 400 V/230 V (50-60 Hz)
Terminals:	L1, L2, L3, B1
Upper level cos-φ:	adjustable 0.1 - 0.99
Bottom level cos-φ:	adjustable 0.1 - 0.99
Max. permanent voltage:	(input L1, L2, L3) AC 3x 460 V
Current range:	0.1 - 16 A
Current overloading:	20 A (< 3 sec.)
Hysteresis:	adjustable 5 % or 10 %
Time delay t1:	adjustable 0.1 - 10 s
Time delay t2:	adjustable 0.1 - 10 s

**Accuracy**

Accuracy setting (mechanical):	5 %
Accuracy of repetition:	< 1 %
Temperature dependence:	< 0.1 %/°C (°F)
Limit values tolerance:	5 %

**Output**

Number of contacts:	2x changeover/SPDT (AgNi/Silver Alloy)
Current rating:	16 A/AC1; 1 HP 240 Vac, 1/2 HP 120 Vac; PD. B300
Breaking capacity:	4000 VA/AC1, 384 W/DC
Inrush current:	20 A/< 3 s
Switching voltage:	250 V AC/24 V DC
Output indication:	yellow LED
Mechanical life:	10.000.000 ops.
Electrical life (AC1):	100.000 ops.

**Other information**

Operating temperature:	-20 .. 55 °C (-4 .. 131 °F)
Storage temperature:	-30 .. 70 °C (-22 .. 158 °F)
Dielectrical strength:	4 kV (supply - output)
Operating position:	any
Mounting:	DIN rail EN 60715
Protection degree:	IP40 from front panel/IP20 terminals
Overvoltage category:	III.
Pollution degree:	2
Max. cable size (mm <sup>2</sup> ):	max. 1x 2.5, max. 2x1.5/ with sleeve max. 1x 1.5 (AWG 12)
Dimensions:	90 x 52 x 65 mm (3.5" x 2" x 2.6")
Weight:	243 g/8.6 oz (230 V, 110 V, 400 V); 141 g/5 oz (24 V)
Standards:	EN 60255-1, EN 60255-26, EN 6255-27

- Relay monitors phase shift between current and voltage in 3-phase or 1-phase networks - evaluates COS φ (replacement COS-1).
- The relay is designed to monitor overload/relieve the motors.
- Relay is designed for 3 x 400/230 V circuits.
- Galvanically isolated power supply AC 230 V, AC 110 V, AC 400 V or AC/DC 24 V.
- Adjustable upper and lower level COS φ.
- Possibility to extend the current range using a current transformer.
- Two output relays (for each level independent).
- Adjustable delay eliminating engine start-up.

**Description**

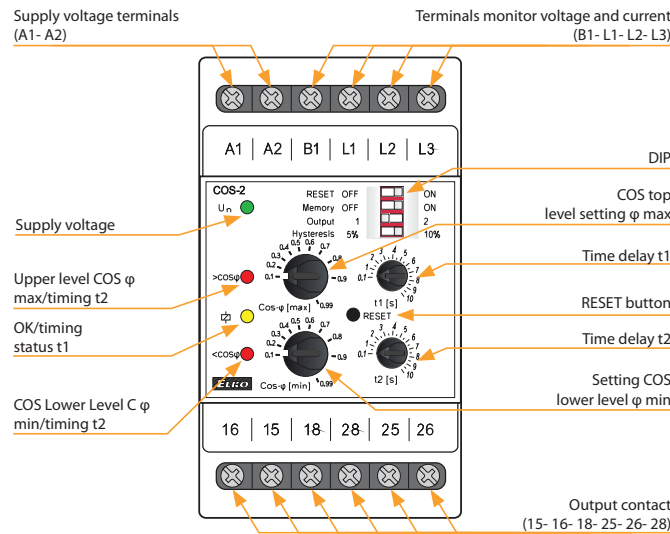

**Description and importance of DIP switches**

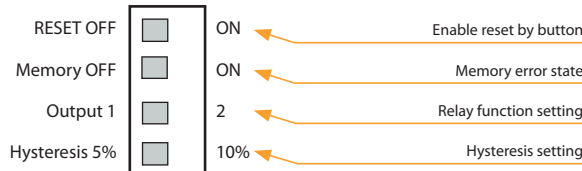

**Connection**

Connection with current transformer      3-phase connection      1-phase connection

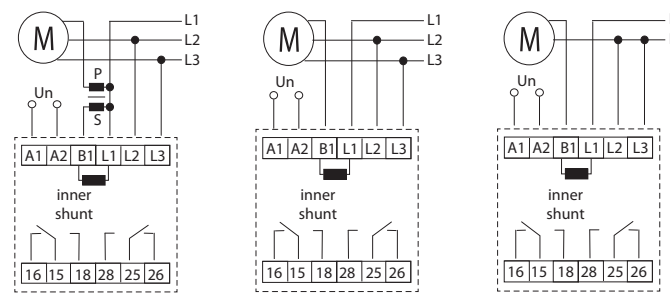

**Symbol**

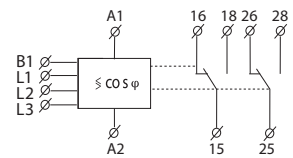



Status after switching on power, two relay mode

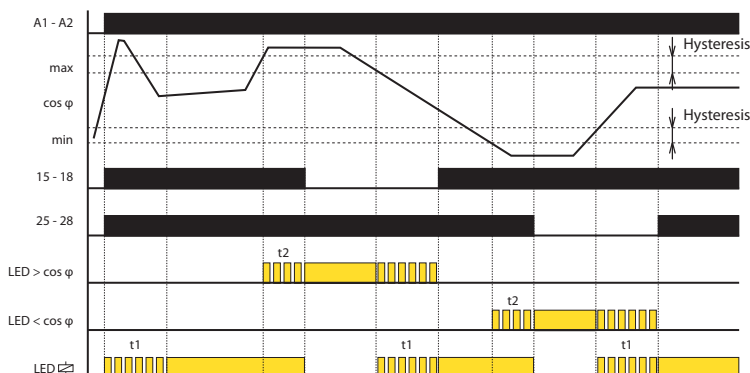

Memory on, two relay mode

decrease (loss) of current

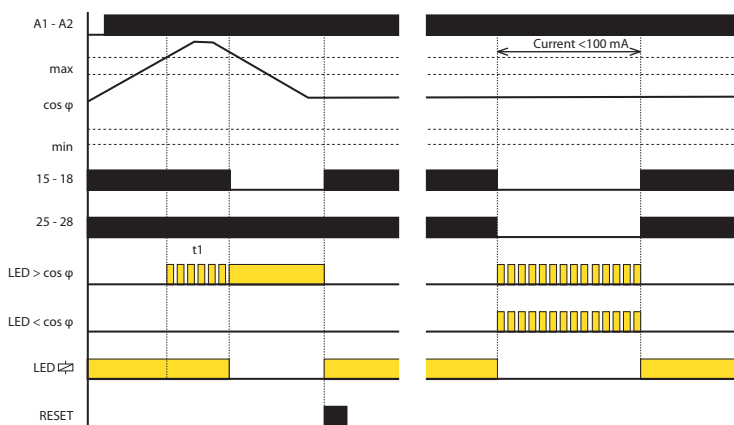

After powering on, the device sets the delay time t1 and yellow LED flashes. Both relays are switched on. The delay serves to eliminate a faulty state when starting the motor. After the time delay t1 begins monitoring COS φ only.

If the COS φ is in the band between the upper and lower limits set, both relays are switched on and the yellow LED is on.

If the COS φ is outside the set limits (> COS φ max or <COS φ min), an error condition occurs - the time t2 is delayed while the red LED corresponding to the COS φ blinks at the same time. After the time delay t2 red LED lights and the corresponding relay remains off.

When the COS φ returns to set limits, the time t1 is delayed and the yellow LED flashes at the same time as the corresponding red LED. After the time delay stops blinking yellow LED, the corresponding red LED turns off and the relay switches on.

At low wattage (<100 mA) or with a power failure, an error is reported by the simultaneous blinking of both red LEDs. After resuming the voltage or the current being watched, the relay returns to the normal state where the COS φ value is monitored.

When the memory is turned off (DIP switch 2 OFF) and the allowable reset (DIP switch 1 ON), the pressing state is reached after the power is turned on, i.e. flashing yellow LED, both relays are switched on, with time delay t1.

When the memory (DIP switch 2 ON) is in an error state (high or low value for cos φ) it should be reset (by pressing the RESET button).



- The relay serves to monitor frequency of AC voltage, e.g. in photovoltaic power stations, generators.
- The monitored frequency 50/60/400 Hz is selected by a switch.
- Two adjustable levels of frequency (Fmin, Fmax) in the range of 80 - 120 % Fn.
- Adjustable difference level.
- Adjustable delay level.

EAN code  
HRF-10: 8595188144827

Technical parameters	HRF-10
Supply and monitoring terminals:	L, N
Supply voltage:	AC 161 - 500 V
Rated frequency Fn:	(50/60/400 Hz)
Burden (max):	1.7 VA/1.1 W
Max. dissipated power (Un + terminals):	2 W
Overload capacity	
- continuous:	500 V
- max.10 s:	550 V
Frequency Fmax:	adjustable 80 - 120 % Fn
Frequency Fmin:	adjustable 80 - 120 % Fn
Difference:	adjustable 0.5 - 5 % Fn
Delay (until failure):	adjustable 0.5 - 10 s
Opening level (Uopen):	161 V
Output relay - contact:	2x changeover/SPDT (AgNi) gilded
AC contact capacity:	250 V/8 A, max. 2000 VA*
DC contact capacity:	30 V/8 A
Mechanical life:	30.000.000 ops.
Electrical life (AC1):	200.000 ops.

Other information	
Operational temperature:	-20 .. 55 °C (-4 .. 131 °F)
Storing temperature:	-30 .. 70 °C (-22 .. 158 °F)
Dielectrical strenght (supply - relay contact):	4 kV/1 min.
Protection degree:	III.
Overvltage category:	2
Pollution degree:	IP40 from front panel/IP20 terminals
Profile of connecting wires (mm <sup>2</sup> ):	max. 2x 1.5/1x 2.5 (AWG 12)
Dimensions:	90 x 52 x 64 mm (3.5" x 2" x 2.6")
Weight:	127 g (4.5 oz.)
Standards:	EN 61000-6-2, EN 61000-6-4, EN 60255-1, EN 60255-26, EN 60255-27

\*8 A/AC1; 1/3 HP|240 Vac, 1/4 HP|120 Vac; PD. B300

Connection

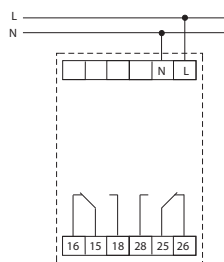

Rated frequency setting

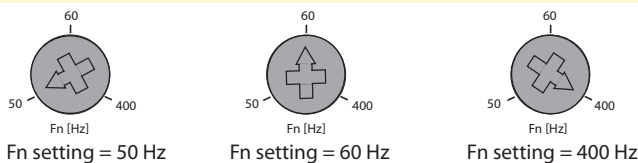

Device description

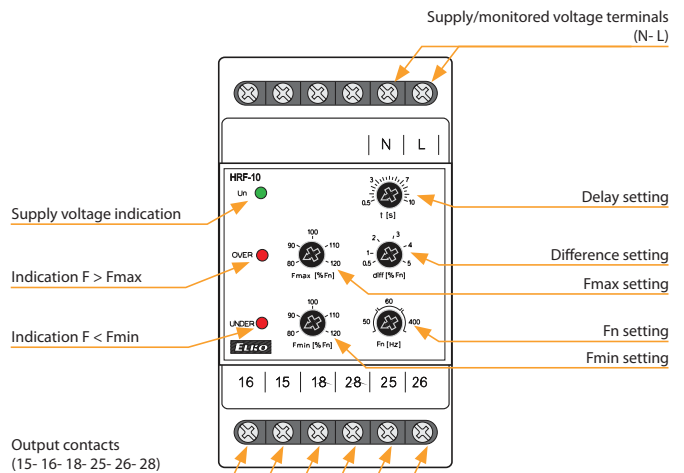

Functions

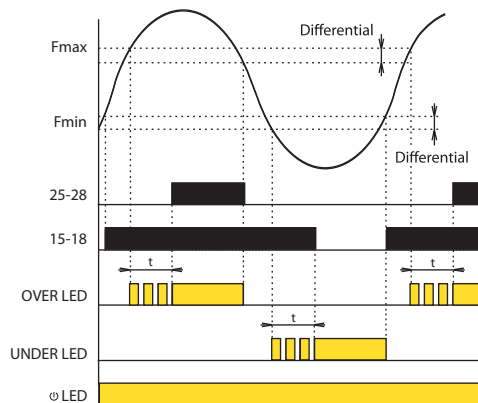

After the supply (monitored) voltage is connected, the green LED is on. If the value of the monitored frequency falls within the range between the two set levels Fmin - Fmax no red LED is on. The relay UNDER is triggered (contacts 15-16-18) and the relay OVER is disconnected (contacts 25-26-28).

If the monitored frequency exceeds the set level Fmax, the relay OVER is triggered after the set delay timing elapses and the red LED OVER goes on. The red LED flashes during the timing.

If the monitored frequency drops below Fmax - difference, the relay is activated without delay and the red LED OVER goes off.

If the monitored frequency drops below the set level Fmin, the relay UNDER is disconnected after the set delay timing elapses and the red LED UNDER goes on. The red LED flashes during the timing. If the monitored frequency exceeds the level Fmin + the difference, the relay is triggered without delay and the red LED UNDER goes off.

If the monitored voltage is lower than the opening level Uopen both the relays are disconnected and both the red LED (UNDER and OVER) start flashing slowly - indicating insufficient supply voltage.

AC



**PRI-32**  
Monitoring by current transformer (wire through an opening, galv. separated, without heat loss), adjust. current 1-20 A, multivoltage AC 24-240 and DC 24 V, output 8 A changeover. page 113



**PRI-34**  
Multifunction current monitoring relay, measured by built-in current transformer, 5 rated currents (1 A-16 A), 1 A and 5 A range is suitable for external current transformer, AC/DC supply 24-240 V, output 8 A prep. page 114



**PRI-35**  
Undercurrent monitoring relay, measured by external current transformer, rated current 5 A, AC/DC supply 24-240 V, output 16 A prep. page 116



**PRI-51**  
Monitoring of current by in-built transformer, 7 ranges, range 5 A is suitable for current transformer, supply and output as PRI-32, difference from PRI-32: direct monitoring and finer ranges (higher sensitivity) = higher accuracy in measuring. page 118



**PRI-52**  
For monitoring the current up to 25 A. Long distance device diagnostics (black-out, increment of take-off). Priority relay. Supplying voltage AC 230 V. Output 8 A/SPST switching over. page 119



**PRI-53**  
For monitoring the current in 3-phase devices. Power supply: 24-240 V AC/DC, galvanically separated from the circuit of the monitored current, rated current in 5 A. page 120

AC/DC



**PRI-41**  
(HYSTERESIS function) monitoring AC/DC current 1.6-16 A, divided into 3 inputs and 3 ranges, 2 independent outputs 16 A, 2x time delay page 117



**PRI-42**  
(WINDOW function). Other functions (applicable for PRI-41): faulty state memory, hysteresis, galv. isolated supply. page 117

Type	Design	Supply voltage	Galvanically separated	Monitored parameters					Setting			Description	Page
				Phases	Range	∧	∨	∨∧	Delay	Hysteresis	Memory faultS		
PRI-32	1-M	AC 24-240 V DC 24 V	●	1	AC 1 - 20 A	●	x	x	x	x	x	Monitors the overflow of the current flowing through the guarded conductor, passed through the hole in the panel.	113
PRI-34/1A PRI-34/2A PRI-34/5A PRI-34/8A PRI-34/16A	1-M	AC/DC 24-240 V	x	1	AC 0.05 - 1 A AC 0.1 - 2 A AC 0.25 - 5 A AC 0.4 - 8 A AC 0.8 - 16 A	●	●	●	●	●	●	Monitors the current depending on the selected function. The power supply is not galvanically isolated from the monitored current terminals. It is possible to connect ext. current transformer.	114
PRI-35	1-M	AC/DC 24-240 V	x	1	AC 0.5 - 5 A	x	●	x	●	x	x	Protects the pump motor (submersible pump) against no-load operation with ext. current transformer. The power supply is not galvanically separated from the monitored current terminals. Terminals A2, B2 are internally connected.	116
PRI-51/0.5A PRI-51/1A PRI-51/0.1-10A PRI-51/2A PRI-51/5A PRI-51/8A PRI-51/16A	1-M	AC 24-240 V DC 24 V	●	1	AC 0.05 - 0.5 A AC 0.1 - 1 A AC 0.1-10 A AC 0.2 - 2 A AC 0.5 - 5 A AC 0.8 - 8 A AC 1.6 - 16 A	●	x	x	●	x	x	Monitors the excess current flowing through the conductor connected to the monitored terminals. The power supply is galvanically isolated from the monitored current terminals. It is possible to connect ext. current transformer.	118
PRI-52	1-M	AC 230 V	●	1	AC 0.5 - 25 A	●	x	x	●	x	x	Monitors the overflow of the current flowing through the guarded conductor, passed through the hole in the sidewall.	119
PRI-53/5	6-M	AC/DC 24 - 240 V	●	3	AC 3 x 2 - 6 A	●	●	x	●	x	x	Monitors current drop or overcurrent in 3-phase connection. The power supply is not galvanically isolated from the monitored current terminals. Up to three current transformers can be connected to the product.	120
PRI-41/UNI	3-M	AC/DC 24 - 240 V	●	1	AC/DC 1.6 A AC/DC 5 A AC/DC 16 A	x	x	●	●	●	●	Monitors current drop or overshoot in 1-phase connection. Galvanically isolated power supply. Choice of three monitored current ranges.	117
PRI-42/UNI	3-M	AC/DC 24 - 240 V	●	1	AC/DC 1.6 A AC/DC 5 A AC/DC 16 A	x	x	●	●	●	●		



EAN code  
PRI-32: 8595188121965

Technical parameters		PRI-32
<b>Supply circuit</b>		
Supply terminals:	A1 - A2	
Voltage range:	AC 24 - 240 V, DC 24 V (AC 50-60 Hz)	
Burden:	max. 1.5 VA/1 W	
Max. dissipated power (Un + terminals):	2 W	
Operating range:	-15 %; +10 %	
<b>Measuring circuit</b>		
Current range:	1 - 20 A (AC 50-60 Hz)	
Current adjustment:	potentiometer	
<b>Accuracy</b>		
Setting accuracy (mech.):	5 %	
Repeat accuracy:	< 1 %	
Temperature dependency:	< 0.1 %/°C (°F)	
Limit values tolerance:	5 %	
Overload capacity:	max. 100 A/10 s	
<b>Output</b>		
Number of contacts:	1x changeover/SPDT (AgNi/Silver Alloy)	
Current rating:	8 A/AC1; 1/3 HP 240 Vac, 1/4 HP 120 Vac; PD. B300	
Breaking capacity:	2000 VA/AC1, 240 W/DC	
Output indication:	red LED	
Mechanical life:	60.000.000 ops.	
Electrical life (AC1):	150.000 ops.	
<b>Other information</b>		
Operating temperature:	-20 .. 55 °C (-4 .. 131 °F)	
Storage temperature:	-30 .. 70 °C (-22 .. 158 °F)	
Dielectrical strength:	4 kV (supply - output)	
Operating position:	any	
Mounting:	DIN rail EN 60715	
Protection degree:	IP40 from front panel/IP10 terminals	
Overtoltage category:	III.	
Pollution degree:	2	
Max. cable size (mm <sup>2</sup> ):	solid wire max. 2x 2.5 or 1x 4, with sleeve max. 1x 2.5 or 2x 1.5 (AWG 12)	
Dimensions:	90 x 17.6 x 80.5 mm (3.5" x 0.7" x 3.2")	
Weight:	75 g (2.6 oz.)	
Standards:	EN 60255-1, EN 60255-26, EN 60255-27	

**Symbol**

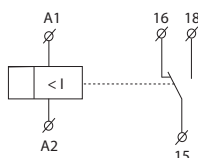

- Current transformer is a part of the product. Inside this transformer there is a wire which senses the volume of flowing current.
- This construction reduces thermal stress of product when compared with conventional solutions with inbuilt shunt, and increases current range up to 20 Amps, and galvanically separates monitored circuit.
- For heating bars in sliding rails, heating cables, indication of current flow, controlling of 1-phase motor consumption,...
- Supply is galvanically separated from measuring current.
- Current exceeding - current flowing through monitored wire must not exceed 100 A.

**Description**

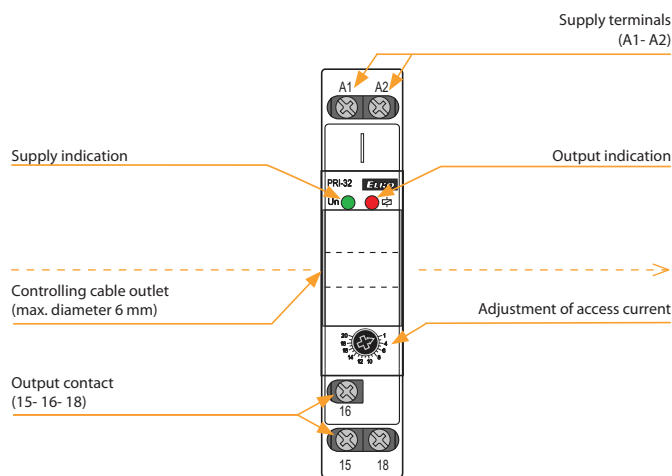

**Function**

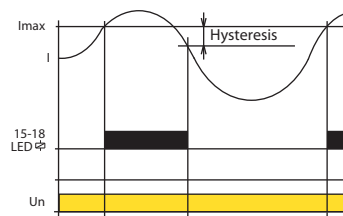

Monitoring relay PRI-32 serves to monitor current level in single phase AC circuits. Due to its fluent adjustment of release current, it is predestined for applications with necessity of current flow indication, and can be used as precedence relay. Output relay is off in normal state. In case the set current level is exceeded, it switches. Multivoltage supply is an advantage.

**Connection**





EAN code  
 PRI-34/1A: 8595188188968  
 PRI-34/2A: 8595188182829  
 PRI-34/5A: 8595188182836  
 PRI-34/8A: 8595188188975  
 PRI-34/16A: 8595188182843

**Technical parameters** **PRI-34**

**Supply**

Supply terminals:	A1 – A2
Supply voltage:	AC/DC 24 – 240 V (AC 50-60 Hz)
Consumption (max.):	3.8 VA/0.7 W
Supply voltage tolerance:	-15 %; +10 %

**Measuring circuit**

Current range:	PRI-34/1A   In - 1A PRI-34/2A   In - 2A PRI-34/5A   In - 5A PRI-34/8A   In - 8A PRI-34/16A   In - 16A (AC 50-60 Hz)
Max. permanent current   peak overload (1 s):	PRI-34/1A   2A/10A PRI-34/2A   4A/10A PRI-34/5A   10A/16A PRI-34/8A   16A/16A PRI-34/16A   17A/32A
Upper level setting (Imax):	10 – 100 %In
Lower level setting (Imin):	5 – 95 %In
Time delay (d):	300 ms
Time delay (t):	adjustable, 0.5 – 10 s

**Accuracy**

Setting accuracy (mech.):	5 %
Repeat accuracy:	< 1 %
Temperature dependency:	< 0.1 %/°C
Limit values tolerance:	5 %
Hysteresis (fault to OK):	5 % (function O1, U1, W) Imax – Imin (function O2, U2)

**Output**

Contact type:	1x changeover (AgNi)
Current rating:	16 A/AC1; 1 HP 240 Vac, 1/2 HP 120 Vac; PD. B300
Breaking capacity:	4000 VA/AC1, 384 W/DC1
Switching voltage:	250 V AC/24 V DC
Power dissipation (max.):	1.2 W
Mechanical life:	10.000.000 ops.
Electrical life (AC1):	100.000 ops.

**Other information**

Operating temperature:	-20 .. +55 °C (-4 .. 131 °F)
Storage temperature:	-30 .. +70 °C (-22 .. 158 °F)
Dielectric strength:	AC 4 kV (supply – output)
Operating position:	any
Mounting:	DIN rail EN 60715
Protection degree:	IP40 front panel / IP20 terminals
Overvoltage category:	III.
Pollution degree:	2
Cross-wire section – solid/stranded with ferrule (mm <sup>2</sup> ):	max. 1x 2.5, 2x 1.5/ max. 1x 2.5 (AWG 14)
Dimensions:	90 x 17.6 x 64 mm (3.5" x 0.7" x 2.5")
Weight:	60 g (2.15 oz)
Standards:	EN 60255-1, EN 60255-26, EN 60255-27

- It is used to monitor the value of alternating current, e.g.: motors, heating cables, lamps and other devices.
- Power supply and monitoring circuits are not galvanically isolated.
- Monitors current exceeding the upper current level (Imax) and falling below the lower current level (Imin) – according to the selected function.
- Smooth adjustment of both current levels.
- Adjustable time delay (to eliminate short-term current drops and spikes).
- Option to select functions with fault state memory (Latch).
- Measures true root mean square value of the current - TRUE RMS.
- Possibility to extend the current range using an external current transformer.

**Description**

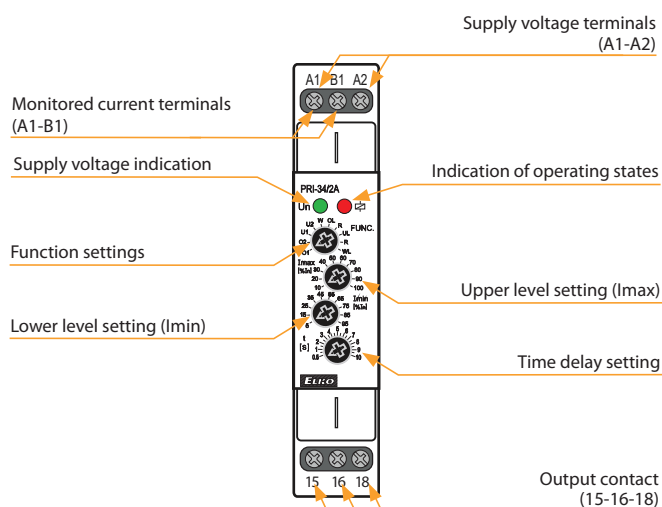

**Connection**

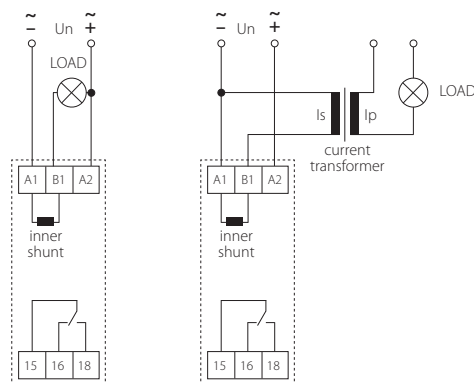

**Indication of operating states**

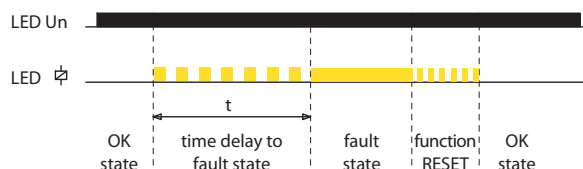

Function

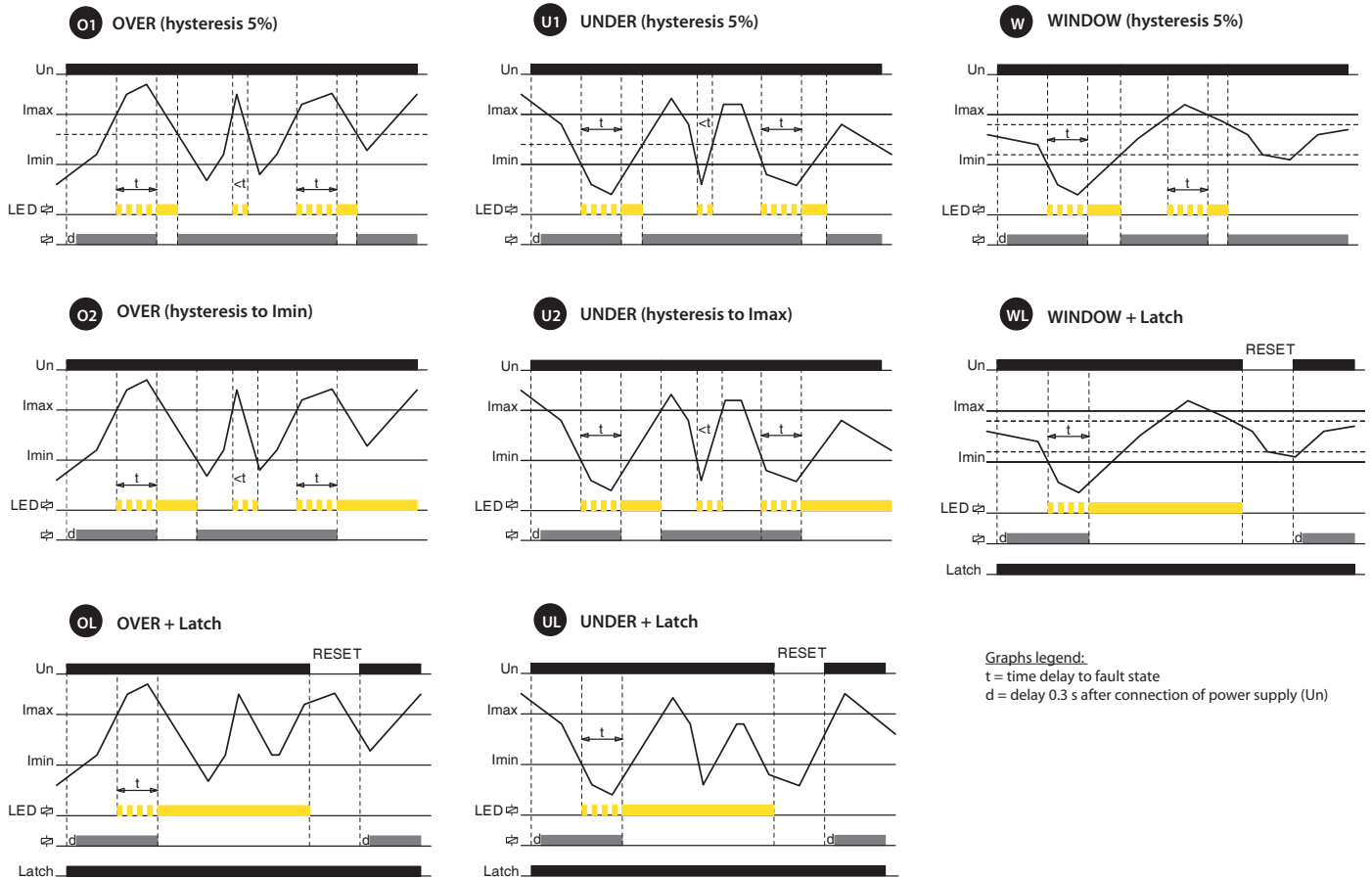

**OVER:**

- If the value of the monitored current is lower than the set upper level „ $I_{max}$ “, the output contact is closed. If the „ $I_{max}$ “ is exceeded, the output contact will open after the set delay (fault state).
- If the current falls below the fixed hysteresis (function O1) or the set lower level „ $I_{min}$ “ (function O2), the output contact will close again.
- If the OL function (OVER + Latch) is selected, when the upper current level „ $I_{max}$ “ is exceeded, the output contact remains open even when the current returns from the fault state.

**Fault memory reset can be done in two ways:**

- Short-term interruption of supply voltage.
- By setting the function switch to position R (RESET) or any function without memory fault.

The RESET state lasts for 3 s after switching the function switch from the R position to a function with memory fault (UL, OL, WL).

When moving to any other function from the R position, this delay does not apply.

**UNDER:**

- If the value of the monitored current is higher than the set lower level „ $I_{min}$ “, the output contact is closed. When the current drops below the „ $I_{min}$ “, output contact opens after the set delay (fault state).
- If the current exceeds the fixed hysteresis (function U1) or the set upper level „ $I_{max}$ “ (function U2), the output contact closes again.
- If the UL function (UNDER + Latch) is selected, when the current drops below the lower level „ $I_{min}$ “, the output contact remains open even when returning from the fault state. Fault memory reset can be done as in the previous case.

**WINDOW:**

- If the value of the monitored current is lower than upper level „ $I_{max}$ “ and at the same time higher than lower level „ $I_{min}$ “, the output contact is closed. If the „ $I_{max}$ “ is exceeded or drops below the „ $I_{min}$ “, output contact opens after the set delay (fault state).
- To return from the fault state, a fixed hysteresis is applied.
- If the WL function (WINDOW + Latch) is selected, the fault state is again stored in memory and output contact stays open, even when returning from the fault state. Fault memory reset can be done as in the previous cases.





- Designed to protect a motor of a pump (submersible pump) against dry running.
- Monitor a current of a motor by means of current transformer (CT) X/5A.
- Current level ( $I_{SET}$ ) and TRIP delay ( $t$ ) are adjustable by potentiometers
- Indication of operating states by the red LED on the front panel.



- The power supply is not galvanically separated from the monitored current terminals, terminals A2, B2 are internally connected.
- Wiring between B1, S1 and B2, S2 must be insulated and not connected to any external voltage or ground.
- External current transformer X/5A must be used.

### Technical parameters

### PRI-35

#### Supply

Supply terminals:	A1 - A2
Voltage range:	AC/DC 24 - 240 V (AC 50-60 Hz)
Consumption (max.):	3.8 VA / 0.7 W
Supply voltage tolerance:	-15 %; +10 %

#### Measuring circuit

Current range:	adjustable, AC 0.5 - 5A
Max. permanent current:	AC 10 A
Inrush overload < 1s:	30 A
TRIP delay (t):	adjustable, 0.5 - 2.5 s

#### Accuracy

Setting accuracy (mech.):	5 %
Temperature dependency:	< 0.1 % / °C (°F)
Limit values tolerance:	5 %
Hysteresis (fault to OK):	10 %

#### Output

Number of contacts:	1x changeover / SPDT (AgNi)
Rated current:	16 A/AC1; 1 HP 240 Vac, 1/2 HP 120 Vac; PD. B300
Switching power:	4000 VA/AC1, 384 W/DC
Switching voltage:	250 V AC/24V DC
Power dissipation (max.):	1.2 W
Mechanical life:	10.000.000 ops.
Electrical life (AC1):	100.000 ops.

#### Other information

Operating temperature:	-20 .. +55 °C (-4 .. 131 °F)
Storage temperature:	-30 .. +70 °C (-22 .. 158 °F)
Dielectric strength:	4 kV (supply - output)
Operating position:	any
Mounting:	DIN rail EN 60715
Protection degree:	IP40 from front panel / IP20 terminals
Overvoltage category:	III.
Pollution degree:	2
Cable size (mm <sup>2</sup> ):	max. 1x 2.5, max. 2x 1.5/ with sleeve max. 1x 2.5
Dimensions:	90 x 17.6 x 64 mm (3.5" x 0.7" x 2.5")
Weight:	65 g (2.3 oz)
Standards:	EN 60255-1, EN 60255-26, EN 60255-27

#### Connection

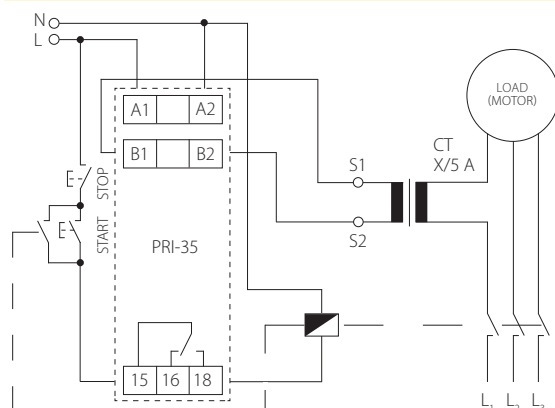

### Description

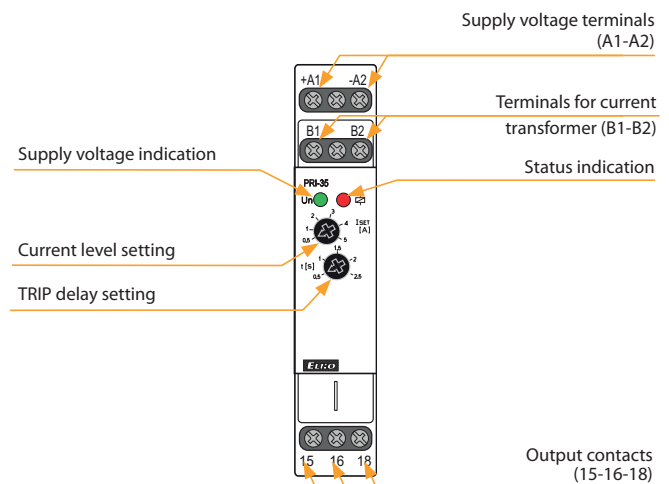

### Function

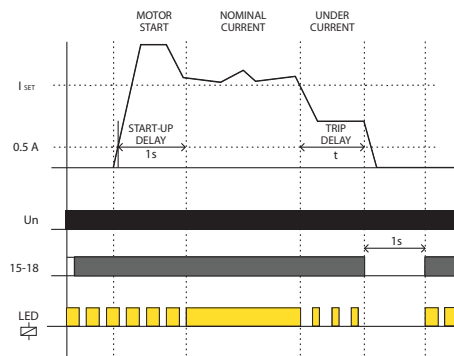

Right after connecting a supply voltage, an output relay is immediately closed and waits for a motor to be started by a START button. Once the START button is activated

a contactor closes and the motor starts. An auxiliary contact of the contactor bridges the START button and keeps the contactor closed.

Fixed START-UP delay prevents undercurrent spikes when the contactor contacts bounce.

If the motor current is higher than the  $I_{SET}$  value after the START-UP delay, the output relay and contactor remain closed.

If the motor current falls below the  $I_{SET}$  value, the TRIP delay is triggered and after running out a set time the output relay opens and contactor drops out.

The output relay is open for 1s, then the output relay closes again and waits for the next start activated by the START button.



EAN code  
 PRI-41/UNI: 8595188185349  
 PRI-41/400V: 8595188147446  
 PRI-42/UNI: 8595188185356  
 PRI-42/400V: 8595188147484

**Technical parameters**      **PRI-41**      **PRI-42**

Supply circuit	
Supply terminals:	A1-A2
Supply voltage:	AC/DC 24 – 240 V (AC 50-60 Hz)
Consumption (max.):	3 VA/1 W
Supply voltage:	AC 400 V (50-60 Hz)
Consumption (max.):	5 VA/2.5 W
Supply voltage tolerance:	-15 %; +10 %

Measuring circuit			
Monitored terminals:	C-B1	C-B2	C-B3
Monitored ranges*:	AC/DC 3.2 – 16 A (AC 50-60 Hz)	AC/DC 1 – 5 A (AC 50-60 Hz)	AC/DC 0.32 – 1.6 A (AC 50-60 Hz)
Input resistance:	2.3 mΩ	11 mΩ	23 mΩ
Max. permanent current:	16 A	8 A	3 A
Inrush overload (1 s):	20 A	16 A	6 A
Time delay Imax (t1):	adjustable, 0.1 – 10 s		
Time delay Imin (t2):	adjustable, 0.1 – 10 s		

Accuracy	
Setting accuracy (mech.):	5 %
Repeat accuracy:	< 1 %
Temperature dependance:	< 0.1 %/°C (°F)
Limit values tolerance:	5 %
Hysteresis (fault to OK):	selectable, 5 %/10 % from the upper range value

Output	
Contact type:	2x changeover/SPDT (AgNi)
Current rating:	16 A/AC1; 1 HP 240 Vac, 1/2 HP 120 Vac; PD. B300
Breaking capacity:	4000 VA/AC1, 384 W/DC1
Inrush current:	30 A/< 3 s
Switching voltage:	250 V AC/24 V DC
Power dissipation (max.):	2.4 W
Mechanical life:	10.000.000 ops.
Electrical life (AC1):	100.000 ops.

Other information	
Operating temperature:	-20 .. 55 °C (-4 .. 131 °F)
Storage temperature:	-30 .. 70 °C (-22 .. 158 °F)
Dielectric strength:	
supply – output	AC 4 kV
output 1 – output 2	AC 4 kV
Operating position:	any
Mounting:	DIN rail EN 60715
Protection degree:	IP40 front panel / IP20 terminals
Overtoltage category:	III.
Pollution degree:	2
Cross-wire section – solid/ stranded with ferrule (mm²):	max. 1x 2.5, 2x 1.5/ max. 1x 2.5 (AWG 14)
Dimensions:	90 x 52 x 65 mm (3.5" x 2" x 2.6")
Weight:	UNI – 166 g (5.86 oz), 400V – 248 g (8.7 oz)
Standards:	EN 60255-1, EN 60255-26, EN 60255-27

\* Only one input can be monitored at a time.

- Used to monitor overload/relief (machines, motors, etc.), check consumption, diagnostic on a remote device (burning, short circuit, increased current draw, etc.)
- Relay is used for monitoring AC or DC current in three ranges.
- Monitors level of current in two independent levels (Imax, Imin).
- Setting the monitored upper level (Imax) in % of range.
- Setting the monitored lower level (Imin):  
    in % of the set upper limit (PRI-41, function HYSTERESIS)  
    in % of range (PRI-42, function WINDOW)
- Selectable function of output contacts (independently/in parallel).
- Independent adjustable time delay of both levels (eliminating short-term drops and spikes).
- Galvanically separated power supply from monitoring inputs.
- Output contact for each monitored current level.

**Description**

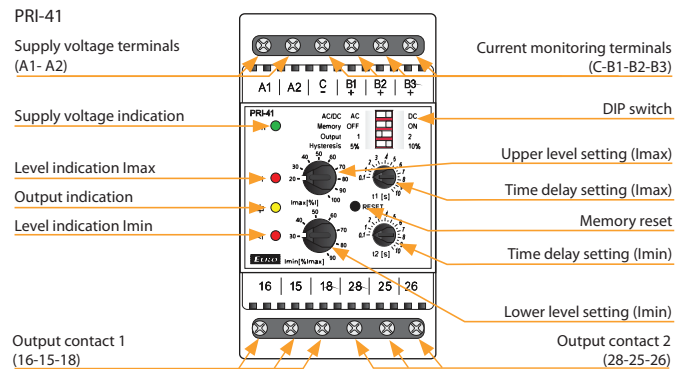

**Description of DIP switch**

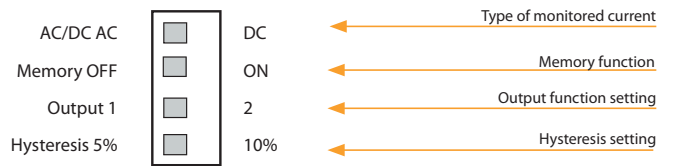

**Function**

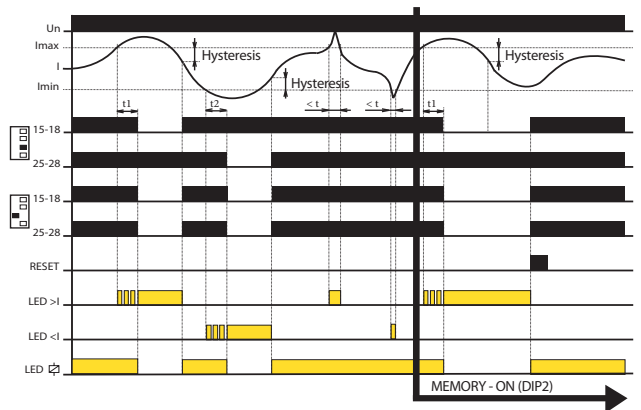

**Connection**

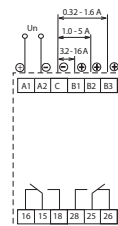

**Symbol**

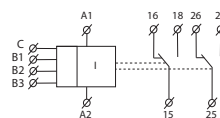

- If the value of the monitored current is in the zone between the set upper and lower levels, the OK state occurs, both output contacts are closed and the yellow LED illuminates. If the value of the monitored current is outside the set limits (> Imax or < Imin), a fault state occurs.
- When moving to a fault state (I > Imax), time delay t1 is running and red LED >I simultaneously flashes. After the time t1 elapses, the red LED >I illuminates and the relevant output contact opens.
- When moving to a fault state (I < Imin), time delay t2 is running and red LED <I simultaneously flashes. After the time t2 elapses, the red LED <I illuminates and the relevant output contact opens.
- When moving from a fault state to the OK state, the relevant red LED immediately goes out, and the corresponding output contact closes.



EAN code	
PRI-51/0.5A:	8595188142885
PRI-51/1A:	8595188124904
PRI-51/2A:	8595188124911
PRI-51/5A:	8595188124928
PRI-51/8A:	8595188124935
PRI-51/0.1-10A:	8595188155717
PRI-51/16A:	8595188124942

Technical parameters		PRI-51
<b>Supply circuit</b>		
Supply terminals:	A1 - A2	
Voltage range:	AC 24 - 240 V and DC 24 V (AC 50-60 Hz)	
Burden:	max. 25 VA/1.6 W	
Max. dissipated power (Un + terminals):	2.5 W	
Supply voltage tolerance:	-15 %; +10 %	
<b>Measuring circuit</b>		
Load:	between B1 - B2	
Current range:	PRI-51/0.5 A: AC 0.05-0.5 A    PRI-51/8 A: AC 0.8-8 A PRI-51/1 A: AC 0.1-1 A        PRI-51/0.1-10 A: AC 0.1-10 A PRI-51/2 A: AC 0.2-2 A        PRI-51/16 A: AC 1.6-16 A PRI-51/5 A*: AC 0.5-5 A        (AC 50-60 Hz)	
Max. permanent current:	PRI-51/0.5 A: 2 A PRI-51/1 A: 4 A PRI-51/2 A: 8 A PRI-51/0.1-10 A: 10 A PRI-51/5 A, PRI-51/8 A, PRI-51/16 A: 17 A	
Inrush overload <1ms:	50 A	
Current adjustment:	potentiometer	
Time delay:	adjustable 0.5 - 10 s	
<b>Accuracy</b>		
Setting accuracy (mechanical):	5 %	
Repeat accuracy:	< 1 %	
Temperature dependency:	< 0.1 %/°C (°F)	
Limit values tolerance:	5 % (10 % for 0.05 - 0.5 A and 0.1 - 10 A range)	
Hysteresis (fault to OK):	5 %	
Mechanical life:	60.000.000 op.	
Electrical life (AC1):	150.000 op.	
<b>Output</b>		
Number of contacts:	1x changeover/SPDT (AgNi/Silver Alloy)	
Current rating:	8 A/AC1; 1/3 HP 240 Vac, 1/4 HP 120 Vac; PD. B300	
Breaking capacity:	2000 VA/AC1, 240 W/DC	
Output indication:	red LED	
<b>Other information</b>		
Operating temperature:	-20 .. 55 °C (-4 .. 131 °F)	
Storage temperature:	-30 .. 70 °C (-22 .. 158 °F)	
Dielectrical strength:	4 kV (supply - output)	
Operating position:	any	
Mounting:	DIN rail EN 60715	
Protection degree:	IP40 from front panel/IP10 terminals	
Overvoltage category:	III.	
Pollution degree:	2	
Max. cable size (mm <sup>2</sup> ):	solid wire max. 2x 2.5 or 1x 4, with sleeve max. 1x 2.5 or 2x 1.5 (AWG 12)	
Dimensions:	90 x 17.6 x 64 mm (3.5" x 0.7" x 2.5")	
Weight:	72 g (2.5 oz.)	
Standards:	EN 60255-1, EN 60255-26, EN 60255-27	

\* applicable also for current transformer

- It serves for monitoring of heating in rail-switches, heating cables, consumption of 1-phase motors, indicates current flow.
- Flexible adjustment by potentiometer.
- Adjustable delay 0.5 - 10 s to eliminate short current peaks.
- It is possible to use for current scanning from current transformer.
- Supply is galvanically separated from measured current, it must be in the same phase.

### Description

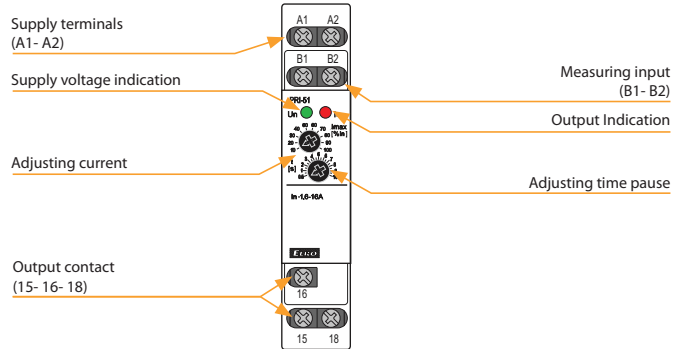

### Function

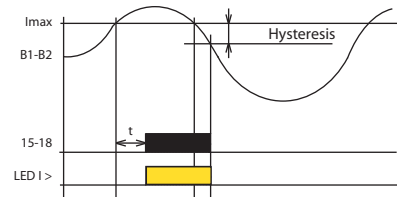

Monitoring relay PRI-51 serves to monitor current level in one-phase AC circuits. Gradual setting of actuating current of monitoring relay enables many different applications. Output relay is in normal state opened. After the set current level is reached, relay closes after the set delay (0.5 - 10 s). When returning from faulty to normal state there is a hysteresis (5 %). Multi-voltage of this relay is an advantage. It is possible to monitor load which doesn't have the same supply as monitoring relay PRI-51.

Range of PRI-51 can be increased by an external current transformer.

### Connection

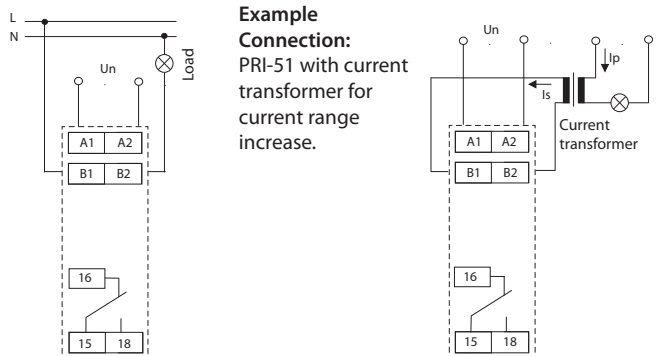

**Example Connection:** PRI-51 with current transformer for current range increase.

### Symbol

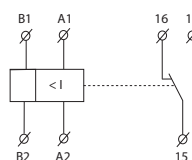

### Example of an order

Always specify all reference name of current relay according to required range, for example PRI-51/5.



EAN code  
PRI-52: 8595188136556

Technical parameters		PRI-52
<b>Supply</b>		
Supply terminals:	A1 - A2	
Voltage range:	AC 230 V (50-60 Hz)	
Power input (apparent/loss):	max. 5 VA/1.4 W	
Max. dissipated power:	2.5 W (U <sub>n</sub> + terminals)	
Supply voltage tolerance:	-15 %; +10 %	
<b>Measuring circuit</b>		
Current range:	AC 0.5 to 25 A (AC 50-60 Hz)	
Maximal permanent current:	25 A	
Inrush overload < 1 s:	50 A	
Current adjustment:	potentiometer	
Time delay:	adjustable 0.5 to 10 s	
<b>Accuracy</b>		
Setting accuracy (mech.):	10 %	
Repeat accuracy:	< 1 %	
Temperature dependence:	< 0.2 %/°C (°F)	
Limit values tolerance:	10 %	
Hysteresis:	0.25 A	
<b>Output</b>		
Number of contacts:	1x changeover/SPDT (AgNi/Silver Alloy)	
Current rating:	8 A/AC1; 1/3 HP 240 Vac, 1/4 HP 120 Vac; PD. B300	
Breaking capacity:	2000 VA/AC1, 240 W/DC	
Output indication:	red LED	
Mechanical life:	60.000.000 ops.	
Electrical life (AC1):	150.000 ops.	
<b>Other information</b>		
Operating temperature:	-20 .. 55 °C (-4 .. 131 °F)	
Storage temperature:	-30 .. 70 °C (-22 .. 158 °F)	
Dielectrical strength:	4 kV (supply - output)	
Operating position:	any	
Mounting:	DIN rail EN 60715	
Protection degree:	IP40 from front panel/IP10 terminals	
Oversvoltage category:	III.	
Pollution degree:	2	
Max. cable size (mm <sup>2</sup> ):	max. 2x 2.5, max. 1x 4/ with sleeve max. 1x 2.5, max. 2x 1.5 (AWG 12)	
Dimensions:	90 x 17.6 x 64 mm (3.5" x 0.7" x 2.5")	
Weight:	65 g (2.3 oz.)	
Standards:	EN 60255-1, EN 60255-26, EN 60255-27	

- Relay is designated for:
  - distant device diagnostic (short circuit, take-off increasing)
  - preferred (priority) relay - two appliances (boiler and floor heating) operating on one phase, but never run together - prevention against current overload and circuit breaker tripping. Enables to save your main breaker expenses
  - current tranzit indicator - informs about heating activation, ceramic hob, ventilator...
  - changing over of appliances according to inverter's (converter) output by photocell applications
- Hole for threaded conductor passes through the body of device.
- Part of device is current transformer, which is sensing size of current in threaded conductor.
- Slight setting (by potentiometer) of tripping current - range AC 0.5 to 25 A.

**Description**

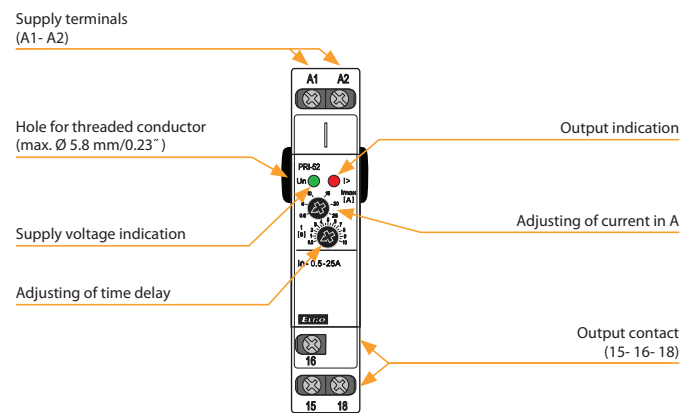

**Functions**

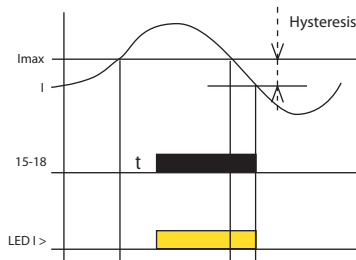

Monitoring relay PRI-52 serves for monitoring of current level in 1-phase AC circuits. Slight setting of release current level designates this relay for many various applications. Output relay is in normal status switched off. When set current level is overrun, relay get closed after preset delay. By return from error to normal status is used hysteresis. Advantage of PRI-52 is that the hole for threaded conductor is located under the level of covering in the switchboard - thanks that, threaded conductor is not accessible for unwanted manipulation.

**Connection**

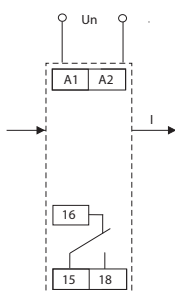

**Symbol**

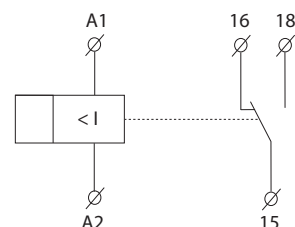

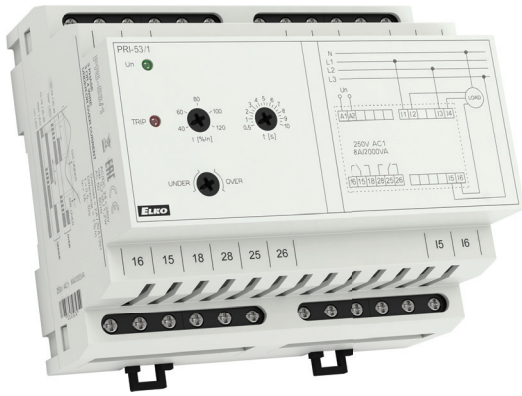

EAN code  
PRI-53/5: 8595188142144

Technical parameters	PRI-53/5
Supply terminals:	A1, A2
Current monitoring terminals	
1st phase:	I1, I2
2nd phase:	I3, I4
3rd phase:	I5, I6
Supply voltage:	24 – 240 V AC/DC
Tolerance of voltage range:	± 10 %
Operating AC frequency:	(50-60 Hz)
Burden (max):	3 VA/1.2 W
Max. dissipated power (Un + terminals):	2.5 W
Rated current In:	AC 5 A
Current level - I:	adjustable 40 – 120 % In
Overload capacity	
Continuous:	10 A
Max. 3s:	50 A
Difference:	fix 1 % In
Delay (until failure):	adjustable 0.5 – 10 s
Output relay - contact:	2x changeover/SPDT (AgNi) gilded
AC contact capacity:	250 V/8 A, max. 2000 VA*
DC contact capacity:	30 V/8 A
Mechanical life:	30.000.000 ops.
Electrical life (AC1):	200.000 ops.

Other information	
Operating temperature:	-20 .. 55 °C (-4 .. 131 °F)
Storing temperature:	-30 .. 70 °C (-22 .. 158 °F)
Dielectric strength	4 kV (power supply – output)
Overvoltage category:	III.
Pollution level:	2
Protection degree:	IP40 from front panel/IP20 terminal
Max. cable size (mm <sup>2</sup> ):	max. 2x 1.5/1x 2.5 (AWG 12)
Dimensions:	90 x 105 x 64 mm (3.5" x 4.1" x 2.5")
Weight:	213 g (7.5 oz.)
Standards:	EN 60255-1, EN 60255-26, EN 60255-27

\* 8 A/AC1; 1/3 HP|240 Vac, 1/4 HP|120 Vac; PD. B300

### Connection

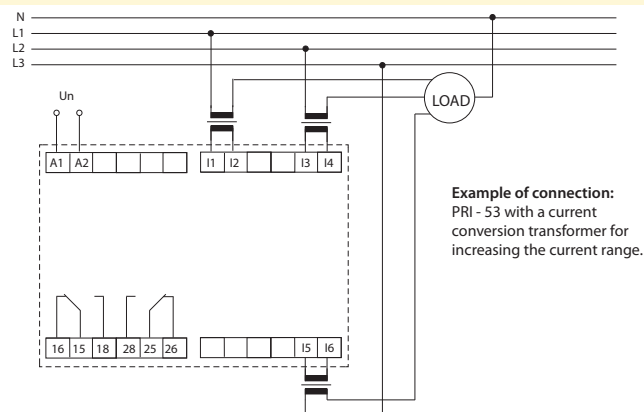

- It is intended for monitoring the current in 3-phase devices (e.g. cranes, motors, etc.).
- 24 - 240 V AC/DC power supply, galvanically separated from the circuit of the monitored current.
- Adjustable delay level (when exceeding the preset limit).
- Adjustable function:
  - UNDER - monitors the drop in the strength of current below the preset value (I)
  - OVER - exceeding the preset value (I).
- Nominal current value 5 A.
- Option of connecting via the current transformers to increase the value of the monitored current.

### Description

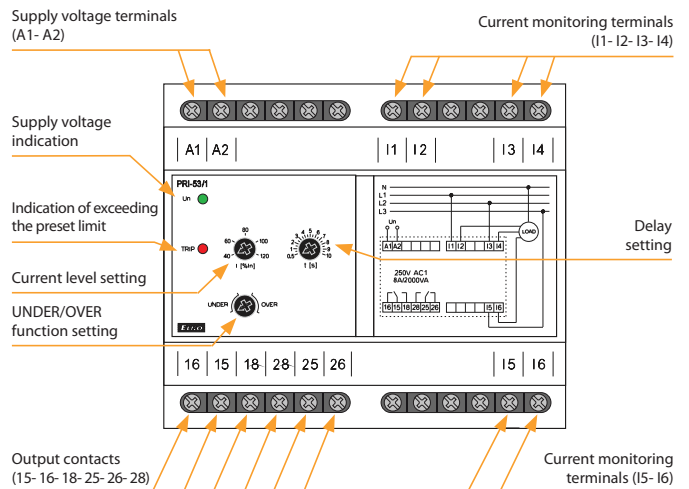

### Functions

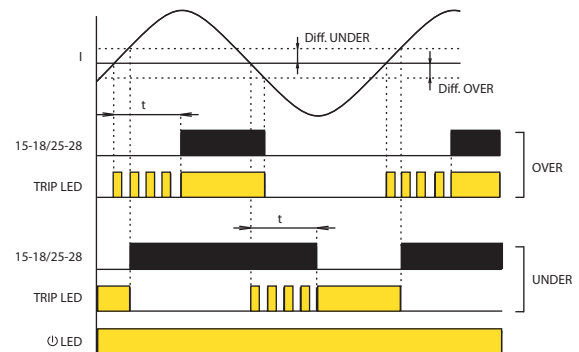

After the supply voltage is connected the green LED is on.

#### UNDER function:

If the strength of the monitored current in all phases exceeds the preset level I, the relay is triggered and the red LED is off. If the strength of the monitored current drops in any phase below the level I, the relay is disconnected after the preset delay timing elapses and the red LED goes on. The red LED flashes during the delay.

If the strength of the monitored current returns above the level I+difference, the relay is triggered without delay and the red LED goes off.

#### OVER function:

If the strength of the monitored current is lower in all phases than the preset level I, the relay is disconnected and the red LED is off.

If the strength of the monitored current exceeds in any phase the level I, the relay is triggered after the preset delay timing elapses and the red LED goes on. The red LED flashes during the delay.

If the strength of the monitored current again drops below the level I - difference, the relay is disconnected without delay and the red LED goes off.



Liquid level switches



**HRH-5**

Simple version, 2 functions, galvanically separated supply voltage UNI 24 to 240 V AC/DC. page 122



**HRH-7**

Suitable to operate in harsh conditions due to the high degree of protection IP65. Switch monitors the level changes in wells, reservoirs, tanks, tankers etc. page 123



**HRH-8**

8 functions, advanced setting for various combinations, galvanically separated supply AC 230 V, AC 110 V, AC 400 V or AC/DC 24 V, 2 output contacts/ 2 PDT 16 A. page 125



**HRH-9**

The relay allows monitoring of up to 6 levels in one tank, while each probe has its own output contact, sensitivity range 10 - 470 kΩ page 127



**HRH-6**

Device monitors 5 levels by using six probes. Supply voltage: 12-24 V DC or galvanically separated 230 V AC. page 129



**HRH-9/S**

Additional probe status signaling to HRH-9. page 127

Level set



**HRH-4**

A set of level relay HRH-5 and contactor VS425. page 131

Accessories



**Level sensors**

SHR-1(M, N) - for monitoring flooding.  
SHR-2- for level detection.  
SHR-3 - for demanding and industrial environment. page 132

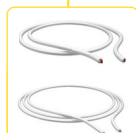

**Cable, wire**

D03VV-F 3x0,75/3,2 - cable to SHR-1 and SHR-2 probes.  
D05V-K 0,75/3,2 - wire to SHR-1 and SHR-2 probes. page 133

Type	Design	Supply voltage	Sensitivity	Monitored parameters		Settings		Description	Page
				Level max.	Level min.	Time delay	Function		
HRH-5	1-M	AC/DC 24-240 V	5 - 100 kΩ	●	●	●	2	Measuring the frequency of 10 Hz will protect liquid from polarisation and measuring probes from increased oxidation. Galv. separated power supply.	122
HRH-7	IP65 BOX	AC/DC 24-240 V	5 - 100 kΩ	●	●	●	2	Suitable to work in harsh conditions due to the high degree of protection IP65.	123
HRH-8/24V HRH-8/110 V HRH-8/230 V	3-M	AC/DC 24 V AC 110 V AC/DC 23 V	5 - 100 kΩ	●	●	●	8	Sensitivity adjustable by potentiometer. Galvanically separated power supply.	125
HRH-9	6-M	AC/DC 24-240 V	10 - 470 kΩ	●	●	●	Universal	It monitors up to 6 level levels, each with its own output contact. Optional filling/draining function for each probe separately incl. delay options. Sensitivity can be set automatically or manually.	127
HRH-6/AC HRH-6/DC	IP65 BOX	AC 230 V AC/DC 12-24V	10 - 200 kΩ	●	●	●	2	Device monitors 5 of liquid levels using 6 probes.	129
HRH-4/230 V HRH-4/24 V	IP65 BOX	AC 230 V AC/DC 24 V	5 - 100 kΩ	●	●	●	2	Unit with no protection devices - adequate protection element needs to be integrated before the unit. Ingress protection of the assembly is IP65.	131





- Relay is designed for monitoring levels in wells, basins, reservoirs, tanks,...
- In one device you can choose the following configurations:
  - One-level switch of conductive liquids (by connecting H and D)
  - Two-level switch of conductive liquids.
- One-state device monitors one level, two-state device monitors two levels (switches on one level and switches off on another level).
- Adjustable time delay on the output (0.5 - 10s).
- Sensitivity adjustable by a potentiometer (5 - 100 kΩ).
- Measuring frequency 10 Hz prevents polarization of liquid and raising oxidation of measuring probes.
- Galvanically separated supply voltage UNI 24 to 240 V AC/DC.

**Device description**

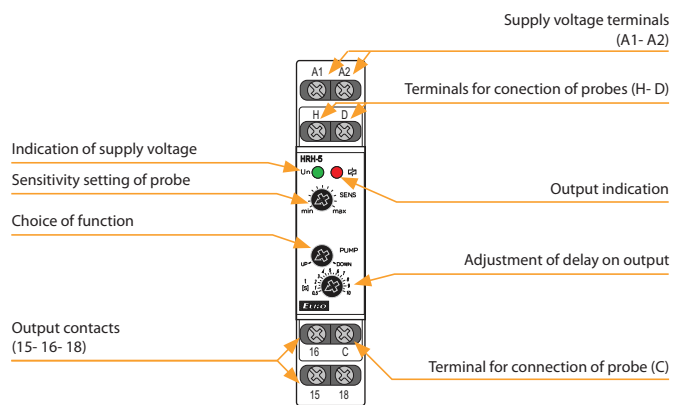

**Function**

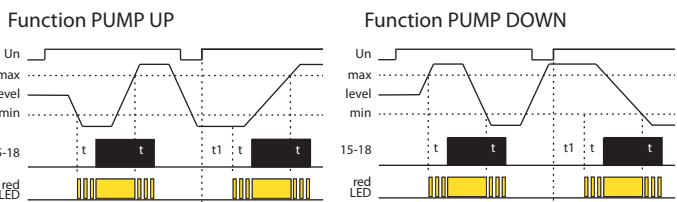

Relay is designated for monitoring of levels of conductive liquids with possibility of functions: PUMP UP or PUMP DOWN. To prevent polarization and liquid electrolysis of liquid, and undesirable oxidation of measuring probes, alternating current is used. For measuring use three measuring probes: H- upper level, D- lower level, C- common probe. In case you use a tank made of a conductive material, you can use it as probe C. In case you require monitoring of one level only, it is necessary to connect inputs H and D and connect them to one probe - in this case sensitivity is lowered by half (2.5 to 50 kΩ). Probe C can be connected with a protective wire of supply system (PE). To prevent undesirable switching out output contacts by various influences (sediment on probes, humidity,...) it is possible to set sensitivity of the device according to conductivity of monitored liquid (corresponding to "resistance" of liquid) range 5 up to 100 kΩ. To reduce influences of undesirable switching of output contacts by liquid gorgle in tanks, it is possible to set delay of output reaction 0.5 - 10 s.

**Connection**

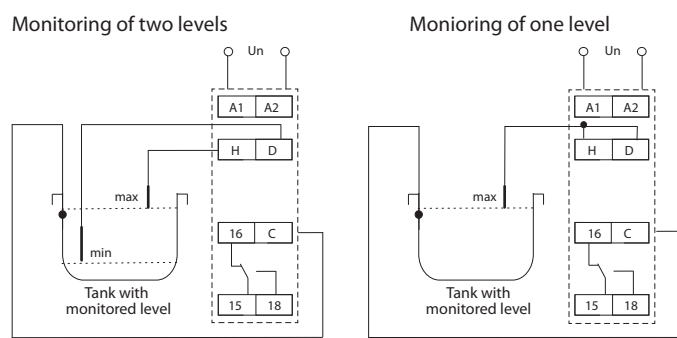

EAN code  
HRH-5: 8595188136396

Technical parameters		HRH-5
Functions:		2
Supply terminals:		A1 - A2
Voltage range:		AC/DC 24 - 240 V (AC 50-60 Hz)
Input:		max. 2 VA/1.5 W
Max. dissipated power (Un + terminals):		2 W
Toleration of voltage range:		-15 %; +10 %
<b>Measuring circuit</b>		
Sensitivity (input resistance):		adjustable in range 5 kΩ - 100 kΩ
Voltage n electrodes:		max. AC 3.5 V
Current in probes:		AC < 0.1 mA
Time response:		max. 400 ms
Max. capacity of probe cable:*		800 nF (sensitivity 5 kΩ), 100 nF (sensitivity 100 kΩ)
Time delay (t):		adjustable, 0.5 -10 sec
Time delay after switching on (t1):		1.5 sec
<b>Accuracy</b>		
Accuracy in setting (mech.):		± 5 %
<b>Output</b>		
Number of contacts:		1x changeover/SPDT (AgNi/Silver Alloy)
Current rating:		8 A/AC1; 1/3 HP 240 Vac, 1/4 HP 120 Vac; PD. B300
Switching voltage:		2000 VA/AC1, 240 W/DC
Switched voltage:		250 V AC/24 V DC
Mechanical life (AC1):		60.000.000 ops.
Electrical life:		150.000 ops.
<b>Other information</b>		
Operational temperature:		-20 .. 55 °C (-4 .. 131 °F)
Storing temperature:		-30 .. 70 °C (-22 .. 158 °F)
Dielectrical strenght:		2.5 kV (supply - sensors)
Operational position:		any
Mounting:		DIN rail EN 60715
Protection degree:		IP40 from font panel/IP10 terminals
Overvltage category:		II.
Pollution degree:		2
Profile of connecting wires (mm²):		max. 2x 2.5, max. 1x 4/ with sleeve max. 1x 2.5, max. 2x 1.5 (AWG 12)
Dimensions:		90 x 17.6 x 64 mm (3.5" x 0.7" x 2.5")
Weight:		73 g (2.6 oz.)
Standards:		EN 60255-1, EN 60255-26, EN 60255-27, EN 60669-1, EN 60669-2-1
Recommended measuring probes:		see pg. 132

\* Max. line length is limited by the capacity between the individual cable cores.

**Symbol**

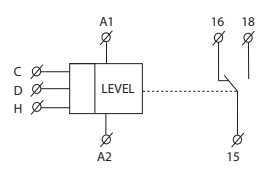



EAN code  
HRH-7: 8595188149471

Technical parameters		HRH-7
Function:		2
Supply terminals:		A1 - A2
Supply voltage:		AC/DC 24 - 240 V (AC 50-60 Hz)
Burden:		max. 2 VA/1.5 W
Max. dissipated power (Un + terminals):		3 W
Supply voltage tolerance:		-15 %; +10 %
Max. value of overcharge protection:		16 A
Measuring circuit		
Sensitivity (input resistance):		adjustable from 5 kΩ - 100 kΩ
Voltage on electrodes:		max. AC 3.5 V
Current on probes:		AC < 0.1 mA
Time response:		max. 400 ms
Max. capacity of probe cable:		800 nF (sensitivity 5kΩ), 100 nF (sensitivity 100 kΩ)
Time delay (t):		adjustable, 0.5 - 10 sec
Time delay (t1):		1.5 sec
Accuracy		
Setting accuracy (mechanical):		± 5 %
Output		
Number of contacts:		1x changeover/DPDT (AgSnO <sub>2</sub> )
Current rating:		16 A/AC1; 1 HP 240 Vac, 1/2 HP 120 Vac; PD. B300
contact NO:		15-18: 6 A/AC3
contact NC:		15-16: 3 A/AC3
Switching capacity:		4000 VA/AC1, 384 W/DC
Switching voltage:		250 V AC/24 V DC
Mechanical life:		30.000.000 ops.
Electrical life (AC1):		100.000 ops.
Other information		
Operating temperature:		-20 .. 55 °C (-4 .. 131 °F)
Storage temperature:		-30 .. 70 °C (-22 .. 158 °F)
Dielectrical strength:		3.75 kV (supply - sensor)
Operating position:		any
Protection:		IP65
Overvoltage category:		III.
Contamination degree:		2
Cable size (mm <sup>2</sup> ):		max. 2x 2.5/ with sleeve max. 2x 1.5 (AWG 12)
Dimension:		139 x 139 x 56 mm (5.5" x 5.5" x 2.2")
Weight:		241 g (8.5 oz.)
Related standards:		EN 60255-1, EN 60255-26, EN 60255-27, EN 60669-1, EN 60669-2-1
Recommended measuring probes:		see pg. 132

- Suitable to operate/work in harsh conditions due to the high degree of protection IP65.
- Switch monitors the level changes in wells, reservoirs, tanks, tankers etc.
- It is possible to select the following configurations:
  - one-level switch of conductive liquids monitors one level (by connecting H and D)
  - two-level switch of conductive liquids monitors two levels (switches on at one level and switched off at another level).
- Adjustable time delay of output (0.5 - 10 s).
- Adjustable sensitivity using potentiometer (5 - 100 kΩ).
- Measuring frequency 10 Hz prevents liquid polarization and increased oxidation of measuring probes.
- Measuring circuits are galvanically separated from the power source of the product and circuits of the relay contact by enhanced insulation according to EN 60664-1 for overvoltage category III.

Device description

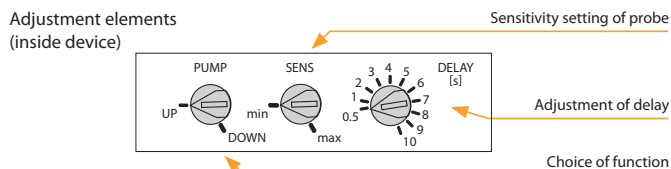
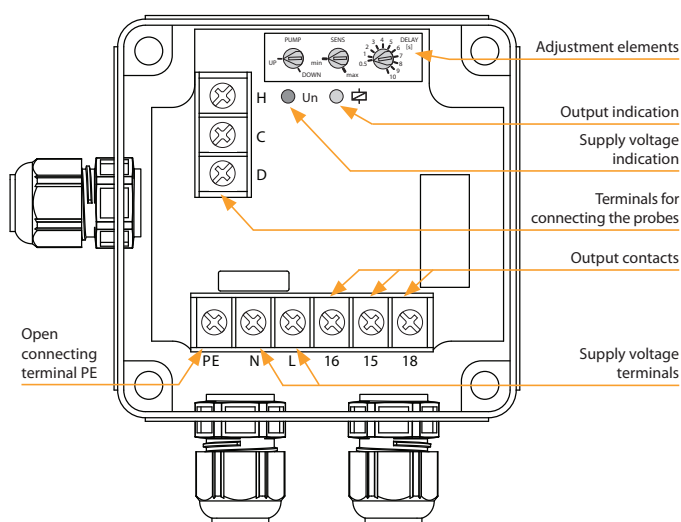

Connection

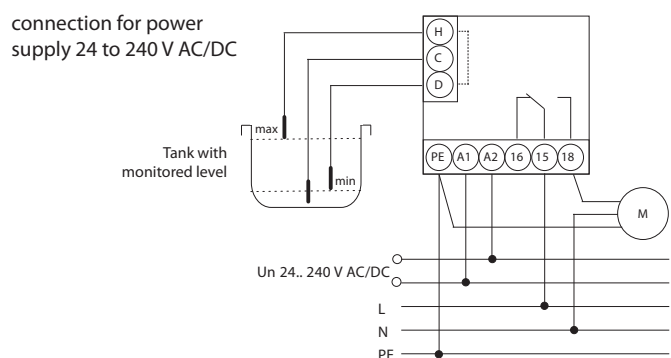
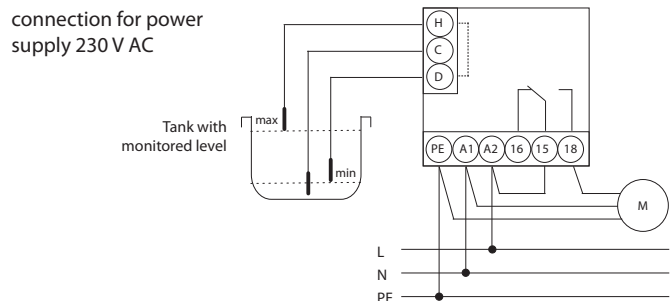

Symbol

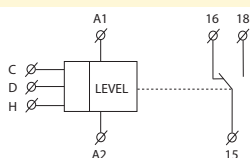

Function



An AC current is used for measuring to prevent polarization and electrolysis of fluid and unwanted oxidation of measuring probes. Three probes are used for measuring: H - upper level, D - lower level and C - common probe. If using a tank made from conductive material, it is possible to use the tank itself as probe C.

If it is necessary to monitor only one level, there are two connection options:

1. Inputs H and D are connected to a single probe - in this case the sensitivity is decreased to half (2.5 to 50 kΩ).
2. Inputs H and C are connected and the probe is connected to input D - in this case, the original sensitivity remains (5 to 100 kΩ).

It is also possible to connect probe C with a protective conductor of the power system (PE).

Example of connecting the level switch to a 1-phase pump at a well, borehole

wiring for supply 230 V AC (for monitoring two levels)

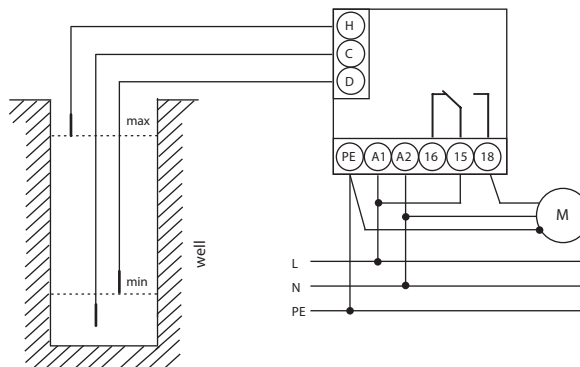

Monitoring TWO LEVELS of the FLUID LEVEL minimum/maximum - DRAINING function - (PUMP DOWN)

Description of draining function:

This function is used in a well or borehole, where the difference between the upper and lower probes determines, how much water the pump can pump out and protect against running dry.

After detecting the maximum level, the set reaction delay begins running. After this period, the output contact immediately switches on the pump, until the minimum level is reached, when the set delay begins running once again. The pump then switches off.

Monitoring TWO LEVELS minimum/maximum - REPLENISHING function - (PUMP UP)

Description of replenishing function:

This function is used when you need to regularly pump in water to a well or borehole, which is leaking.

After detecting the minimum level, the set reaction delay begins running. After this period, the output contact immediately switches on the pump for the period, until it reaches the maximum level, where the set delay begins running once again. The pump then switches off.

Example of connecting the level switch to a 3-phase pump at the well, borehole

wiring for supply 230 V AC (for monitoring two levels)

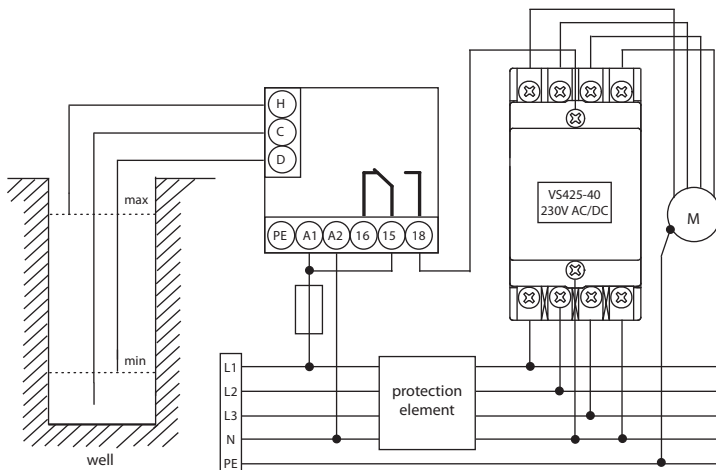

Monitoring TWO LEVELS minimum/maximum - DRAINING function - (PUMP DOWN)

Description of draining function:

The function is used to protect against overflows and flooding of areas. After detecting the maximum level, the set reaction delay begins running. After this period, the output contact immediately switches on the 3-phase pump, until the minimum level is reached, when the set delay begins running once again. The pump then switches off.



EAN code  
 HRH-8/230V: 8595188155427  
 HRH-8/24V: 8595188155564  
 HRH-8/400V: 8595188171199

Technical parameters		HRH-8
Function:	8	
Supply terminals:	A1 - A2	
Voltage range:	AC 230 V, AC 400 V or AC/DC 24V galvanically separated (AC 50-60Hz)	
Burden max.:	2.5 W/5 VA (AC 230 V, AC 400 V), 1.4 W/2 VA (AC/DC 24 V)	
Max. dissipated power (Un + terminals):	4 W (230 V, 400 V); 3 W (24 V)	
Supply voltage tolerance:	-15 %; +10 %	
Measuring circuit		
Hysteresis (input - opening):	in an adjustable range 5 kΩ - 100 kΩ	
Voltage on electrode:	max. AC 3.5 V	
Current in probes:	AC < 1 mA	
Time reaction:	max. 400 ms	
Max. cable capacity:	800 nF (sensitivity 5kΩ), 100 nF (sensitivity 100 kΩ)	
Time delay t:	adjustable 0.5 - 10 sec	
Accuracy		
Setting accuracy (mech.):	± 5 %	
Output		
Number of contacts:	2x changeover/SPDT (AgNi/Silver Alloy)	
Current rating:	16 A/AC1; 1 HP 240 Vac, 1/2 HP 120 Vac; PD. B300	
Breaking capacity:	4000 VA/AC1, 384 W/DC	
Inrush current:	30 A/< 3 s	
Switching voltage:	250 V AC/24 V DC	
Output indication:	red LED	
Mechanical life:	10.000.000 ops.	
Electrical life (AC1):	100.000 ops.	
Other information		
Operating temperature:	-20 .. 55 °C (-4 .. 131 °F)	
Storage temperature:	-30 .. 70 °C (-22 .. 158 °F)	
Dielectric strength:	4 kV (supply - output)	
Operating position:	any	
Mounting:	DIN rail EN 60715	
Protection degree:	IP40 from front panel/IP20 terminals	
Overtoltage category:	III.	
Pollution degree:	2	
Max. cable size (mm <sup>2</sup> ):	solid wire max. 1x 2.5 or 2x1.5/with cavern max. 1x 1.5 (AWG 12)	
Dimensions:	90 x 52 x 65 mm (3.5" x 2" x 2.6")	
Weight:	247 g/8.7 oz (110 V, 230 V, 400 V); 145 g/5.1 oz (24 V)	
Standards:	EN 60255-1, EN 60255-26, EN 60255-27, EN 60669-1, EN 60669-2-1	
Measuring sensors:	see pg. 132	

**Measuring probes**

There can be any measuring probe (any conductive contact, it is recommended to use brass or stainless steel).  
 The probe wire does not need to be shielded, but it is recommended.  
 When using a shielded wire, the shielding is connected to terminal S.

- Relay is designed to control the level of conductive liquids in wells, tanks, pools, tankers, reservoirs,... (replacement HRH-1).
- Galvanically isolated supply and guard circuits.
- Within one device, the following configurations can be selected:
  - 2x one-level monitoring (in separate tanks)
  - 1x two-level monitoring (in one tank)
  - pumping from one tank to another.
- DIP switch selection on the front panel (8 functions).
- Adjustable probe sensitivity (for each probe separately).
- Adjustable relay switching delay (for each probe separately).
- 10 Hz watch frequency prevents polarization of the liquid and increases resistance to interference by network frequency.

**Description**

HRH-8/24V

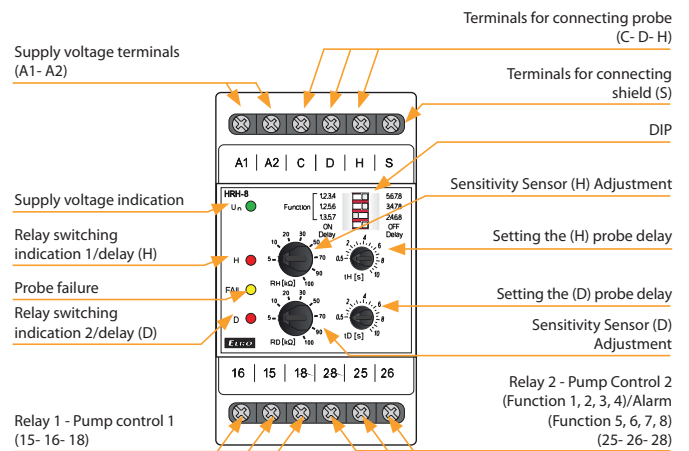

**Description and importance of DIP switches**



**Connection**

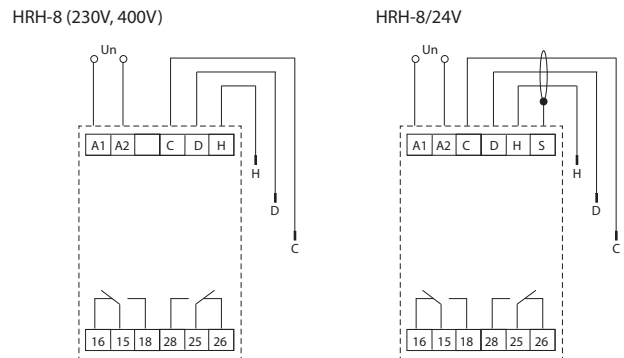

**Symbol**

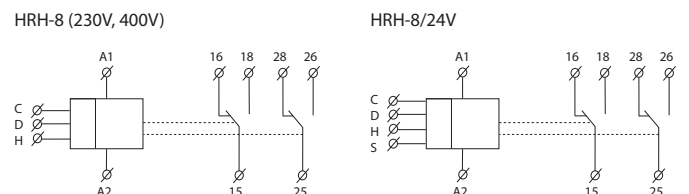

## Functions

PUMP UP, ON DELAY (Function 1,3,4)

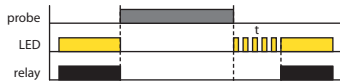

PUMP DOWN, ON DELAY (Function 2,3,4)

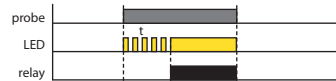

PUMP UP, OFF DELAY (Function 1,3,4)

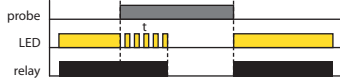

PUMP DOWN, OFF DELAY (Function 2,3,4)



PUMP UP, OFF DELAY (Function 5)

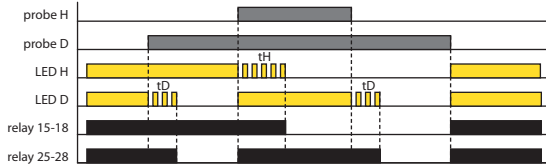

PUMP UP, ON DELAY (Function 5)

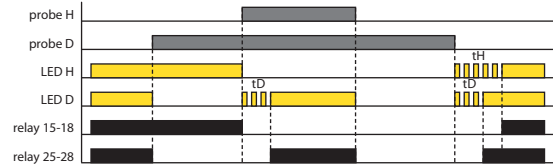

PUMP DOWN, OFF DELAY (Function 6)

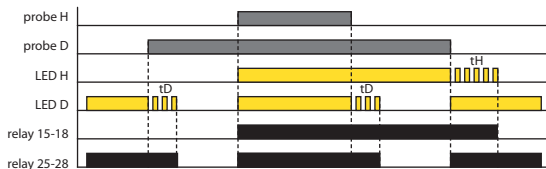

PUMP DOWN, ON DELAY (Function 6)

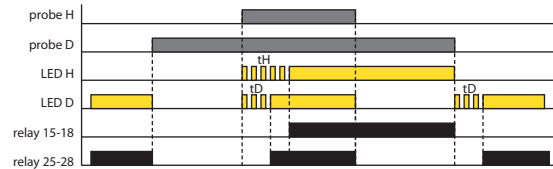

WELL - TANK, OFF DELAY (Function 7)

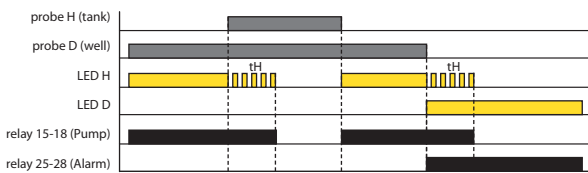

WELL - TANK, ON DELAY (Function 7)

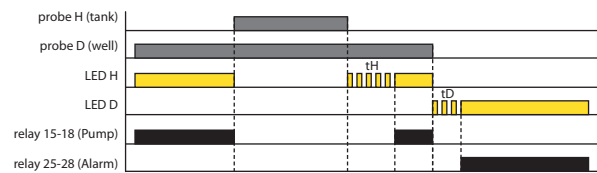

RESERVOIRS - TANK, OFF DELAY (Function 8)

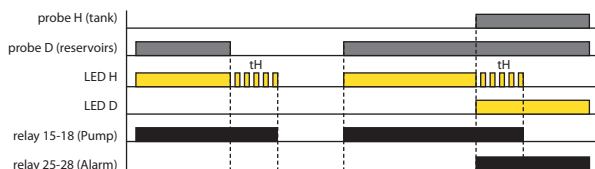

RESERVOIRS - TANK, ON DELAY (Function 8)

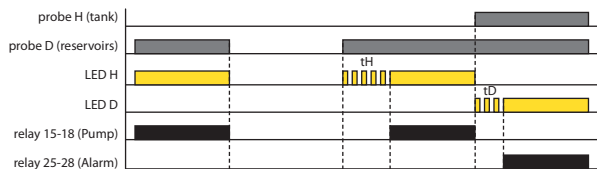

The relay is designed to monitor the level of conductive liquids with a choice of 8 functions:

- 1) - 2 separate tanks (each with 1 probe) - both PUMP UP (filling)
- 2) - 2 separate tanks (each with 1 probe) - both PUMP DOWN (emptying)
- 3) - 2 separate tanks (each with 1 probe) - H PUMP DOWN probe, D PUMP UP probe
- 4) - 2 separate tanks (each with 1 probe) - H PUMP UP probe, probe D PUMP DOWN
- 5) - both probes in one tank - PUMP UP - maintain level between probes H and D (as HRH-5), relay 1 switches on the pump, relay 2 alarm (level is not between probes H and D)
- 6) - Both probes in one tank - PUMP DOWN - maintaining the level between probes H and D (as HRH-5), relay 1 switches on the pump, relay 2 alarm (the level is not between probes H and D)
- 7) - Pumping from the well to the tank - probe D in the well, probe H in the tank. The pump only runs if the probe D is flooded (enough water in the well) and the tank is not full (probe H). The alarm reports a lack of water in the well (probe D is not flooded).
- 8) - Pumping from the sump to the tank - probe D in the sump, probe H in the tank. The pump only runs if the probe D is flooded (full tank) and the tank is not full (probe H). The alarm reports the status of full tank and sump (both probes are flooded).

LED indication:

The red LED lights up - the corresponding relay is switched on  
Red LED flashes - delay timing

The yellow LED indicates probe failure - Functions 5, 6 probe H is flooded and probe D is not. At the same time both red LEDs flash.

To prevent polarization and electrolysis of the liquid and undesirable oxidation of the monitoring probes, an AC current of 10 Hz is used for monitoring. The low frequency has a positive effect on suppression of interference by 50 (60) Hz. Three probes are used to monitor the level: H - upper level, D - lower level and C - common probe. In the case of the use of a conductive material tank, it is possible to use the tank itself as a C probe. Probe C can also be connected to the protective conductor of the power supply system (PE). To prevent undesired switching by various influences (soiling of dips, moisture ...), the sensitivity of the device can be set according to the conductivity of the liquid being monitored (corresponding to the "resistance" of the liquid) in the range of 5 to 100 kΩ. To limit the effect of undesired switching of output contacts by raising the liquid level in the tank, it is possible to set the output response delay 0.5 - 10 s.





EAN code  
HRH-9: 8595188181334  
HRH-9/S: 8595188181853

**Technical parameters** **HRH-9**

**Supply**

Supply terminals:	A1 - A2
Supply voltage:	AC/DC 24 to 240V (AC 50-60Hz)
Supply voltage tolerance:	-15% +10%
galvanically separated voltage:	yes
Burden max.:	2W, 4VA
Max. dissipated power (Un + terminals):	10 W
Power indication:	green LED

**Measuring circuit**

Number of level probes:	6 + 1 common
Adjustable probe function:	PUMP UP, PUMP DOWN, ON, OFF
Voltage on probes:	5V AC max./10Hz
Time reaction in probes:	1,1s
Time delay (PROBE DELAY):	adjustable 0.5 - 10s
Max. capacity of probe cable:	16nF (sensitivity 470 kΩ), 500nF (sensitivity 9,1 kΩ)
Probe sensitivity calibration range:	10kΩ to 470kΩ
Sensitivity range of probes manually (for probes 4, 5, 6):	50kΩ to 470 kΩ
Time delay (START DELAY):	adjustable 0 to 30min
Probe status indication:	red LED + external LED

**Output**

Number of contacts:	6x NO (AgSnO <sub>2</sub> )
Current rating:	10 A/AC1; 1/3 HP 240 Vac; PD. B300
Switching voltage max.:	250V AC
Breaking capacity max.:	2500VA
Mechanical life:	10.000.000 ops.
Electrical life (AC1):	100.000 ops.

**Other information**

Operating temperature:	
Storage temperature:	-20 .. +55°C (-4 .. 131 °F)
Dielectrical strength:	-30 .. +70°C (-22 .. 158 °F)
power supply - probes	AC 4kV
power supply - relay contacts	AC 4kV
contacts of adjacent relays	AC 4kV
Operating position:	any
Mounting:	DIN rail EN 60715
Protection degree:	IP40 from front panel/IP20 terminals
Overvoltage category:	III.
Pollution degree:	2
Max. cable size (mm <sup>2</sup> )	
probes/power supply/signaling:	solid wire max. 1x 2.5 or 2x1.5/with cavern max. 1x 1.5 (AWG 12)
output part:	solid wire max. 1x 2.5 or 2x1.5/with cavern max. 1x 1.5 (AWG 12)
Dimensions:	90 x 105 x 65mm (3.5" x 4.1" x 2.6")
Weight:	252 g (8.9 oz.)
Standards:	EN 60255-1, EN 60255-26, EN 60255-27, EN 60669-1, EN 60669-2-1

- The relay is designed to control the level of conductive liquids in wells, sumps, tanks, pools, tankers, reservoirs ...
- Galvanically separated power and monitoring circuits.
- Possibility to connect up to 6 level probes (+ one common probe).
- Each probe has its own output relay function selection for each probe separately.
- Adjustable delay after power on (START Delay).
- Adjustable relay closing delay (Probe Delay) - common for all probes.
- Automatic calibration of the sensitivity of the probes according to the conductivity of the monitored liquid.
- For probes 4, 5, 6 possibility of manual sensitivity adjustment.
- A monitoring frequency of 10 Hz prevents polarization of the liquid and increases the resistance to mains frequency interference.

**Description**

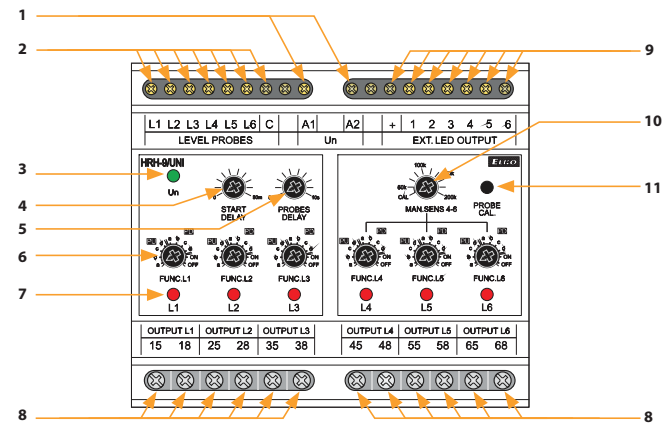

- |                                    |   |
|------------------------------------|---|
| 1 Supply voltage terminals         | 7 Probe status indication (L1)                        |
| 2 Terminals for probes connection  | 8 Probe output contact (L1)                           |
| 3 Supply voltage indication        | 9 Terminals for connecting external signaling HRH-9/S |
| 4 Setting delay after switching on | 10 Manual adjustment of probe sensitivity L4,L5, L6   |
| 5 Delay setting relay closing      | 11 Calibration button of connected probes             |
| 6 Probe function setting (L1)      |   |

**Description**

HRH-9/S

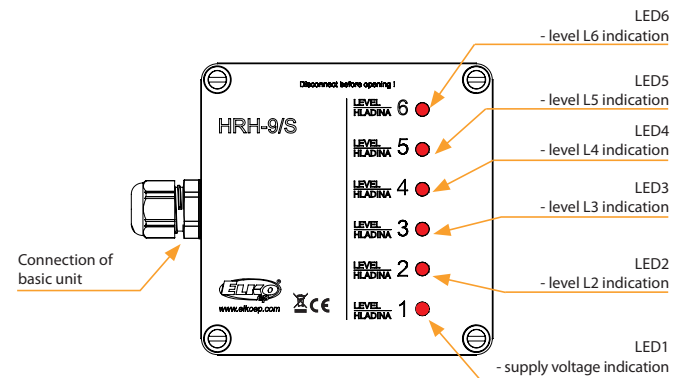



**Function**

**Green LED Un:**

- Flashes for START DELAY after the power is turned on
- During this time the device does not respond to the state of the level probes

- After START DELAY, the green LED lights up permanently

**START DELAY control:**

- sets the START DELAY, delay in the range 0 to 30 minutes

**Level probe function switch FUNC. L1 (L2 to L6):**

A total of 6 level probes L1 to L6 + common probe C can be connected to the device. Each probe has its own function switch, which sets the functions PUMP UP, PUMP DOWN, ON - permanently

Relay closed, OFF - permanently open relay.

- Positions 1 - 4 = PUMP UP

- Positions 5 - 8 = PUMP DOWN

- Position 9 = ON (relay permanently closed, red LED lit)

- Position 10 = OFF (relay open, red LED not lit)

Each of the PUMP UP, PUMP DOWN functions has 4 response delay setting options:

a - function without delay

b - ON DELAY - delayed closing of the relay

c - OFF DELAY - delayed opening of the relay

d - ON/OFF DELAY - delayed closing and opening of the relay

Each probe then controls its output relay depending on the function switch setting. If a probe is not used, its switch must be set to OFF or ON.

**PROBES DELAY control:**

- sets the delay of the relay response to the change of the state of the level probes

- Delay is standard for all probes - range 0.5 to 10s

**LED indication of the status of probes L1 to L6:**

Each probe has its own red LED, indicating the status of the probe + output for external LED additional signalling, which copies the status of the internal red LED:

- Probe is not immersed - the red LED is off

- Probe is immersed, the delay is not running - the red LED is lit.

- Probe has just been immersed and the delay is running - red LED flashes (shorter pulse)

- Probe has just surfaced and a delay is running - red LED flashes (longer pulse)

- Calibration error - red LED flashes quickly

**Wiring example**

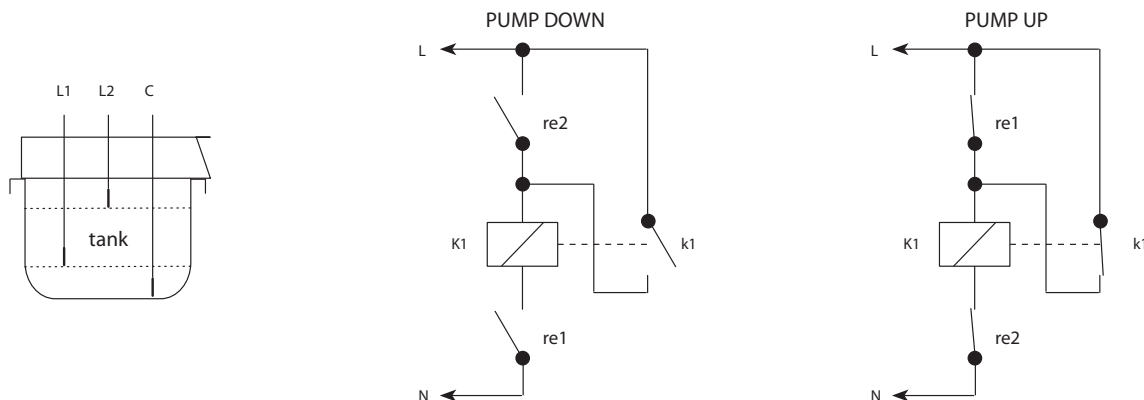

**Level probes in the tank:**

- the common probe C is positioned so that it is always immersed
- the position of the L1 probe determines the lower level, the position of the L2 probe determines the upper level
- the connection is used to maintain the level between the L1 and L2 probes

**Description of the PUMP DOWN function:**

- if the tank is empty, both probes L1 and L2 are not immersed, both relays re1 and re2 are open. Contactor K1 controlling the pump is also open (pump stopped)
- if the tank is filled, after reaching the L1 level the relay re1 closes and the state does not change further
- after reaching the level L2 the relay re2 closes and at the same time the contactor K1 closes (the pump works)
- when the level drops below L2, relay re2 opens, but the contactor remains closed via its switching contact k1
- when the level drops below L1, relay re1 opens and at the same time contactor K1 opens (pump stops)

**Description of the PUMP UP function:**

- if the tank is empty, both probes L1 and L2 are not immersed, both relays re1 and re2 are closed. Contactor K1 controlling the pump is closed (pump is running)
- if the tank is filled, after reaching the level L1 the relay re1 opens - the state does not change - the contactor remains closed via its switching contact k1
- after reaching the level L2, the relay re2 opens and at the same time the contactor K1 (the pump stops)
- when the level drops below L2, relay re2 closes and the state does not change further
- when the level drops below L1, relay re1 closes and at the same time contactor K1 closes (pump starts)

**Connection with additional signalization HRH-9/S**

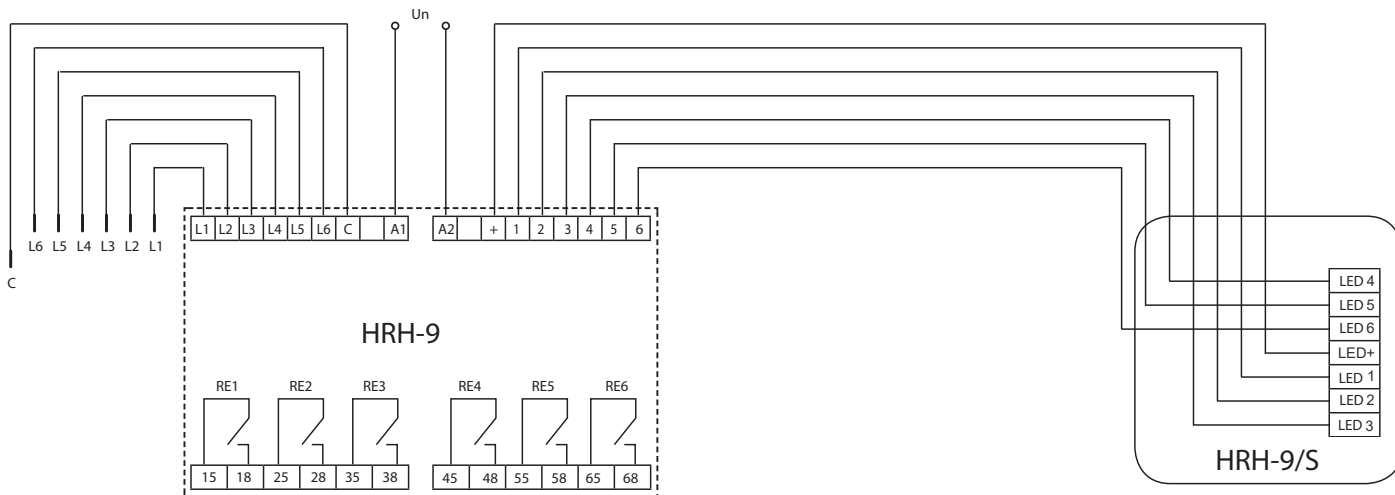



EAN code  
HRH-6/AC: 8595188136990  
HRH-6/DC: 8595188137409

- Function 1 monitors minimal and maximal level depth, for example in fire engine cars, tanks etc.
- Function 2 monitors level depth in water collectors, basins, pools etc.
- Selection of particular function is made by jumper on the front panel.
- Device monitors 5 levels by using six probes (one probe is common).
- Level indication by six LED's on the front panel of the device.
- Measuring frequency 10 Hz to prevent polarization of liquid.
- Supply voltage 12 to 24 V DC (to be used in fire-engines) or galvanically separated 230 V AC for general use.
- Contact relay 10 A for signalization of full/empty tank (according to a chosen function).
- Choice of functions PUMP UP/OFF/PUMP DOWN by a switch located on the front panel of the device.

Technical parameters	HRH-6/DC	HRH-6/AC
Function:	2	
Voltage range:	DC 12 - 24 V	AC 230 V (50-60 Hz)
Burden:	max. 1.8 W	max. 3.8 VA
Max. dissipated power (Un + terminals):	3 W	
Supply tolerance:	± 20 %	-20 % .. +10 %
<b>Measuring circuit</b>		
Sensitivity adjustable in the range*:	min. 10 kΩ max. 200 kΩ	
Voltage on probes:	max. 3 V AC	
Probe cable maximum capacity:	500 nF (for min. sensitivity), 50 nF (for max. sensitivity)	
Time delay:	adjustable 1 to 10 s	
<b>Output</b>		
Number of contacts:	1x switching (AgNi)	
Current rating:	10 A/AC1	
Switching voltage:	2500 VA/AC1, 200 W/DC	
Peak current:	16 A/< 3 s	
Switching voltage:	250 V AC/24 V DC	
Mechanical life (AC1):	10.000.000 ops.	
Electrical life:	100.000 ops.	
<b>Other information</b>		
Operating temperature:	-20 .. +55 °C (-20 .. +55 °F)	
Storage temperature:	-30 .. +70 °C (-30 .. +70 °F)	
Diel. strength (supply - probes):	x	3.75 kV
Operating position:	any	
Protection degree:	IP65	
Overvoltage category:	x	III.
Pollution degree:	2	
Dimensions:	110 x 130 x 72 mm	
Weight:	288 g	385 g
Standards:	EN 60255-1, EN 60255-26, EN 60255-27, EN 60669-1, EN 60669-2-1	
Recommended measuring probe:	see pg. 132	

\* sensitivity is higher at both ends of a range of values.

**Connection**

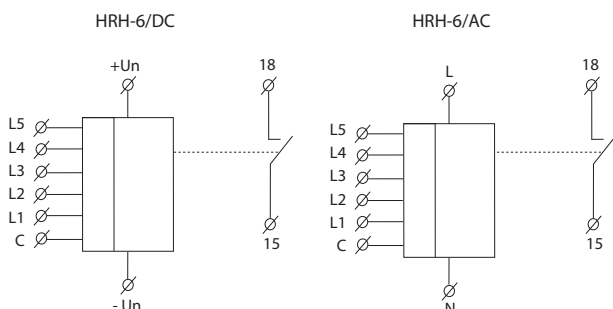

**Description**

HRH-6/DC

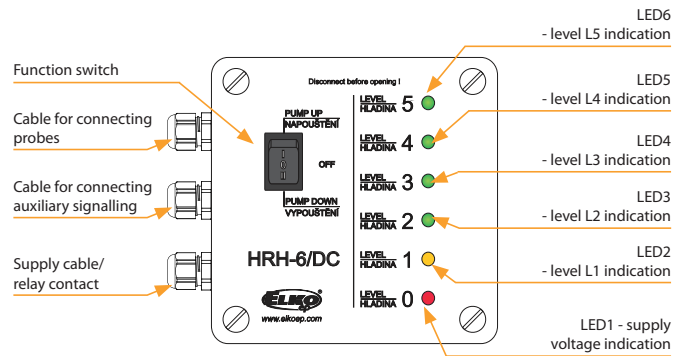

**Setup elements (inside unit)**

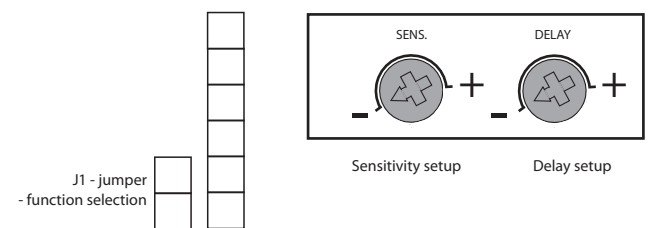

HRH-6 block connecting

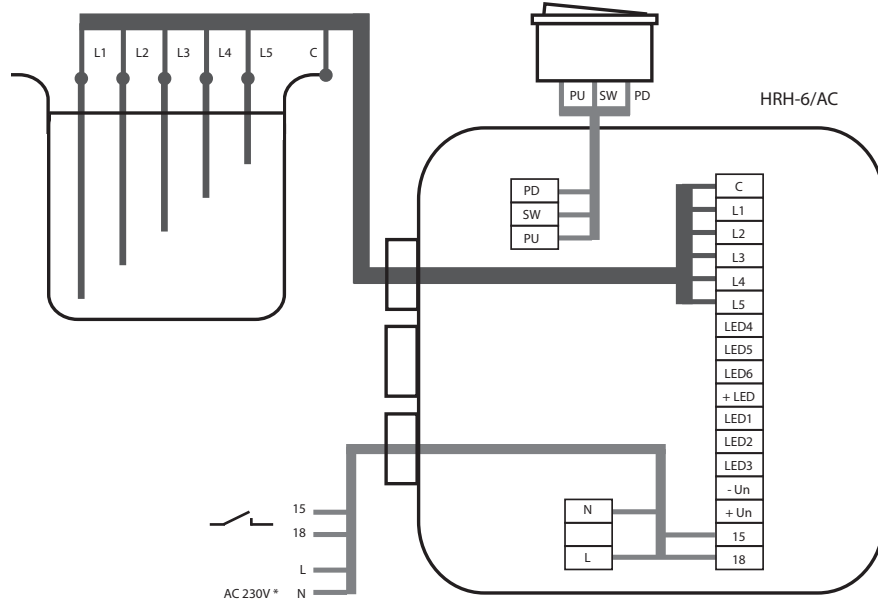

\* In case of HRH-6/DC, incoming supply is connected on terminals +Un and - Un.

Functions

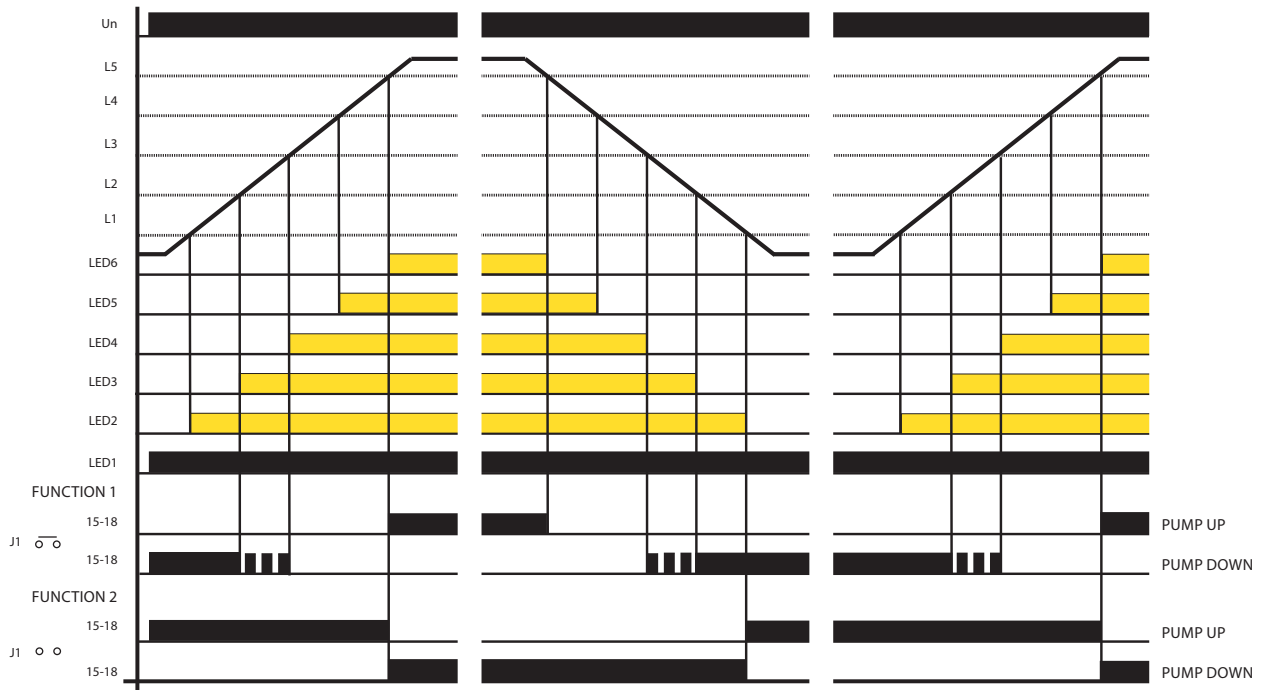

This device monitors level of a conductive liquid in a tank by using six single probes or one 6-fold probe. In case you use a tank made of a conductive material, it is possible to use it as a common probe C.

This common probe is connected to a pole of supply (for fire-engines it means its body) in case of supply voltage 12 to 24 V DC.

In case of supply voltage 230 V AC, the circuits are galvanically separated from the main.

The device is controlled by a three-position switch PUMP UP/OFF/PUMP DOWN. After switching into a position PUMP UP or PUMP DOWN, red LED1 shines and then also LED2 to LED6 according to liquid level. Output relay has 2 selectable functions.

Function setting is done by a jumper on basic board of HRH-6.

**Function 1:** (for use in fire-engines) - jumper is applied. In case of function PUMP UP and level reaching L5, the relay controlling e.g. acoustic signalization, permanently closes and indicates full tank. In case of PUMP DOWN function and level drops under level L3, relay periodically switches and under L2 it switches permanently (indicates almost empty tank).

**Function 2:** (for keeping liquid level) - jumper is not applied. In case of PUMP UP, sensor is switched until liquid reaches level L5. Then relay opens and switches again in case the liquid level falls under level L1. In case of PUMP DOWN - relay is switched until liquid falls under level L1. Then relay opens and switches again on level L5.

To eliminate LED flashing while level gurgles it is possible to delay reaction of probes (set delay 1 to 10 s). According to conductivity of liquid it is possible to set sensitivity of probes (corresponding to "resistance" of liquid).

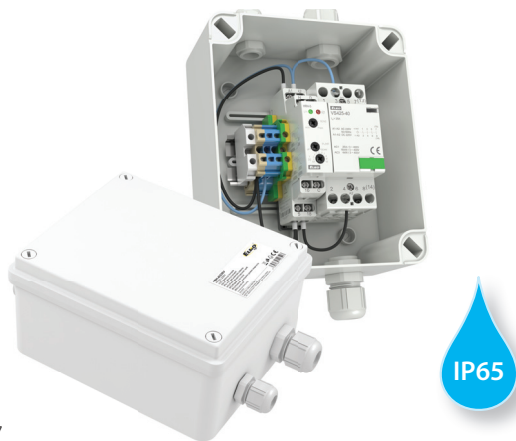

EAN code  
HRH-4/230V: 8595188117517  
HRH-4/24V: 8595188117500

**Technical parameters** **HRH-4**

Function:	2
Voltage range:	AC/DC 230 V or AC/DC 24 V (AC 50-60 Hz)
Burden:	max. 7 VA/1.5 W
Max. dissipated power (Un + terminals):	4 W
Operating range:	-15 %; +10 %

**Measuring circuit**

Sensitivity (input resistance):	adjustable in range 5 kΩ - 100 kΩ
Voltage on electrodes:	max. AC 3.5 V
Current on probes:	AC < 0.1 mA
Time response:	max. 400 ms
Max. capacity of probe cable:	800 nF (sensitivity 5 kΩ), 100 nF (sensitivity 100 kΩ)
Time delay (t):	adjustable, 0.5 - 10 sec
Time delay (t1):	1.5 sec

**Accuracy**

Setting accuracy (mech.):	± 5 %
---------------------------	-------

**Output**

Number of contacts:	4x switching
Rated thermal current:	25 A*
Loading in AC3:	4 kW/400 V
Mechanical life:	6.000.000 ops.
Electrical life (AC1):	150.000 ops.

**Other information**

Operation temperature:	-20 .. 55 °C (-4 .. 131 °F)
Storage temperature:	-30 .. 70 °C (-22 .. 158 °F)
Dielectrical strength (supply-output):	3.75 kV, galvanically insulated
Operating position:	any
Protection degree:	IP65
Pollution degree:	2
Dimensions:	160 x 135 x 83 mm (6.3" x 5.3" x 3.3")
Weight:	743 g (26.2 oz.)
Standards:	EN 60255-1, EN 60255-26, EN 60255-27, EN 60669-1, EN 60669-2-1
Recommended measuring probes:	see pg. 132

\* 1-phase 1 HP|240 Vac, 1/3 HP|120 Vac  
3-phase 3 HP|240 Vac, 5 HP|460 Vac

**Function description**

- 1) PUMP UP - in case the level falls under a lower limit (sensor D), a relay switches and a pump pumps a liquid up until it reaches an upper limit (probe H), then a relay opens and a pump stops pumping. When a level reaches a lower limit again, all process is repeated. After the device is energized, relay automatically closes and a pump pumps liquid to upper limit.
- 2) PUMP DOWN - in case a level reaches over an upper limit, a relay closes and a pump pumps liquid down. In case a level reaches a lower limit, a relay opens and a pump stops pumping. When energized, a relay is in an open state and a pump operates only after an upper limit is exceeded.
- 3) In case you combine inputs H and D and connect them to one probe, the device will keep only one level (upper and lower limit will become one). In function PUMP UP relay closes in case the level falls under a probe level. A pump pumps liquid up and in case the level reaches a probe level, a relay opens and a pump stops. The level is kept in a small range around the probe. In function PUMP DOWN relays closes in case a level reaches a probe level. A pump pumps down until the level reaches a probe, then relay opens and pump stops.

- In an easy way it automates operations of pumps depending on level.
- Control of level in wells, tanks, reservoirs,...
- It is delivered as a connected set - easy installation.
- Possibility to monitor level of any type of conductive liquid.
- It serves for an automatic operation in 1-phased and 3-phased pumps.
- Set of level switch HRH-5 and a contactor VS425.
- Function choice - pumping up or down.
- Unit requires incoming over-current protection.
- Protection degree of the set is IP65.
- There is a possibility of 4 types of probes in a various design (they are not a part of this set, it is possible to deliver).
- Unit is placed in a plastic box with dimensions 160 x 135 x 83 mm (6.3"x 5.3"x 3.3").

**Function**

**Function PUMP UP**

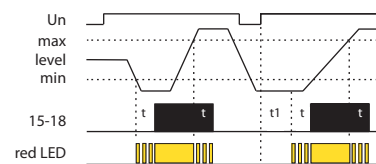

**Function PUMP DOWN**

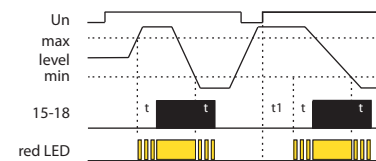

**Connection**

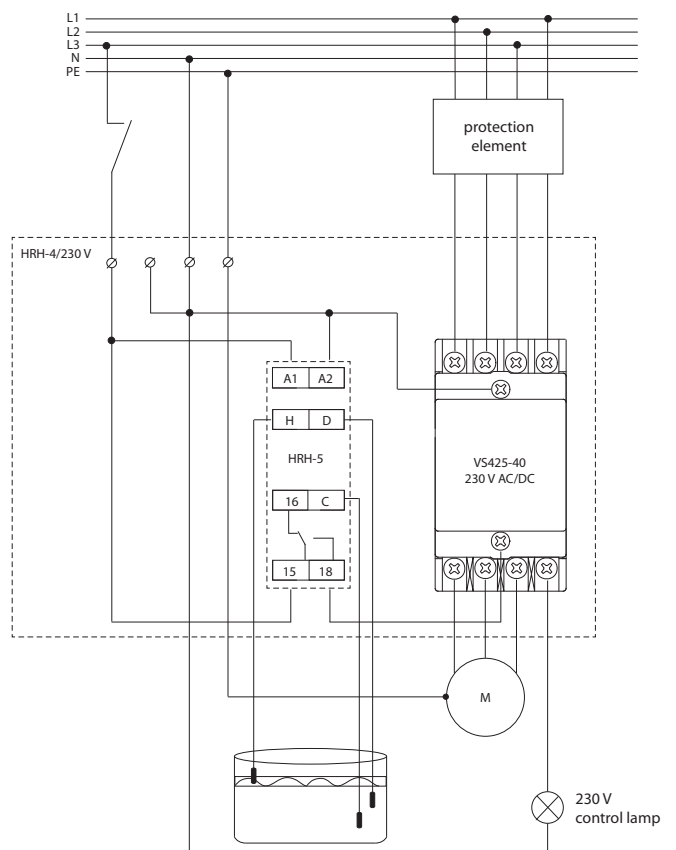

**SHR-1-M, SHR-1-N**

SHR-1-M

SHR-1-N

EAN code  
SHR-1-M: 8595188110105  
SHR-1-N: 8595188111379

**SHR-1-M:** brass sensor**SHR-1-N:** stainless steel sensor

- Sensor to control flooding.
- Electrode with diameter 4 mm (0.2") is placed in plastic cover.
- Panel or to holder mounting.
- Suitable for use in drinking water.
- Conductor is connected to terminal board, shrink bushing for feeder place insulation is a part of device.
- Max. wire profile: 2.5 mm<sup>2</sup> (AWG10).
- Installation: after connecting a wire to the sensor, run the shrink bushing over the wire onto the sensor.
- Heat the sensor and by shrinking the connection of sensor and wire will be hermetical.
- Weight: 9.7 g (0.3 oz.)
- Operating temperature: -25 °C to +60 °C (-13 °F to 140 °F)
- Total sensor length: 65.5 mm (2.58")

**SHR-2**

EAN code  
SHR-2:8595188111263

Level probe **SHR-2**

- Detection sensor is electrode, which in connection with switchable device is used for level detection for example in wells, tanks,...
- To be used in electric conductive fluids and mechanically polluted fluids with temperature: 1°C to 80°C (33.8 °F to 176°F).
- Suitable for use in drinking water.
- Stainless steel one-pole electrode reside in PVC cover, intended for tank wall mounting or mounting by socket.
- To ensure correct function of the sensor, it is necessary to have the electrode without dirt which could disable the connection of the electrode and fluid and thus lead to malfunction.
- Max. wire profile: 2.5 mm<sup>2</sup> (AWG 10).
- Recommended wire D05V-K0.75/3.2.
- Installation:
  - conductor wire is connected by feazing of two brass screws to stainless steel electrode,
  - conductor is caulked by bushing Pg7 with protection degree IP68.
- Weight: 48.6 g (1.7 oz.)
- Dimensions: max. diameter 21 mm (0.8"), length 96 mm (3.8")

SHR-2 in open state

**SHR-3**

EAN code  
SHR-3: 8595188111270

Level probe **SHR-3**

- Stainless probe to be used into demanding industrial environments, designated for screwing into tank wall or cover.
- The probe is installed in horizontal, vertical or in sidelong position on tank side or in tank cover. Installation is done by soldering or by fixing nut. It is necessary to use 24 mm (1") screw. It is necessary to use an adequate torque with regards to a seal and operational overpressure in a tank.
- Sensor has connecting wire - length 3 m, which is connected to sensor to scan electrode and sensor bushing connecting wire is double-wire PVC AWG 18 (0.75 mm<sup>2</sup>), connection of wires: brown - scan electrode, blue - sensor bushing.
- Connection M18x1.5 screw.
- Protection degree IP67.
- Sensor weight without cable: 100 g (3.3 oz.).
- Operating surroundings: place without the danger of detonation, temperature on screw: max. 95°C (203°F).
- Pressure immunity: on 25 °C (77 °F) 4 MPa, on 95 °C (203 °F) 1.5 MPa.
- Weight: 239 g (8.4 oz.).
- Material: bushing and scan electrode: stainless steel W.Nr. 1.4301, insulation insert of electrode: PTFE.
- Internal material: self-extinguishing epoxide resin.
- Operating temperature: -25 °C to 60 °C (-13 °F to 140 °F).
- Total sensor length: 65.5 mm (2.58").
- Dimensions to see on page 159

**D03VV-F** | Cables 3x 0.75 mm<sup>2</sup>

- Cable to probes SHR-1 and SHR-2, 3x 0.75 mm<sup>2</sup> (AWG 18), 1m (39.37').
- Suitable for use in drinking water.
- Construction:
  - bright copper stranded core of hole
  - core insulation of special PVC
  - sheath of special PVC.
- Technical specifications and usage:
  - usable up to 70 °C (158 °F)
  - suitable for submersible conductivity probes for the boreholes, wells and tanks
  - suitable for probes used for level detection of conductive liquids
  - cable capacity is max. 12.3 nF/100 m (328').

EAN code  
D03VV-F 3x0.75/3.2: 8595188165884

Technical parameters	D03VV-F 3x0.75/3.2
Rated voltage:	300/300 V
Test voltage:	2 kV
Capacity:	max. 12.3 nF/100 m (328')
Core diameter with insulation:	3.2 mm (0.12")
Overall diameter of cable:	8.1 mm (0.31")
Section:	0.75 mm <sup>2</sup> (AWG 18)
Length:	1 m (39.37")

## Cross-section

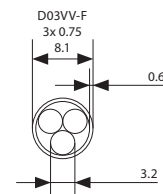
**D05V-K** | Wire 1x 0.75 mm<sup>2</sup>

- Cable to probes SHR-1 and SHR-2, 3x 0.75 mm<sup>2</sup> (AWG 18), 1m (3.4').
- Suitable for use in drinking water.
- Construction:
  - bright copper stranded core of hole
  - insulation of special PVC.
- Technical specifications and usage:
  - usable up to 70 °C (158 °F)
  - suitable for probes used for level detection of conductive liquids.

EAN code  
D05V-K 0.75/3.2: 8595188165945

Technical parameters	D05V-K 0.75/3.2
Rated voltage:	300/500 V
Test voltage:	2 kV
Capacity:	max. 12.3 nF/100 m (328')
Core diameter with insulation:	3.2 mm (0.12")
Section:	0.75 mm <sup>2</sup> (AWG 18)
Length:	1 m (3.4')



## Analog modular

**TER-3A**

-30 .. 10 °C  
(-22 .. 50 °F)  
external NTC.  
page 136

**TER-3B**

0 .. 40 °C  
(32 .. 104 °F)  
external NTC.  
page 136

**TER-3C**

30 .. 70 °C  
(86 .. 158 °F)  
external NTC.  
page 136

**TER-3D**

0 .. 60 °C  
(32 .. 140 °F)  
external NTC.  
page 136

**TER-3G**

0 .. 60 °C  
(32 .. 140 °F)  
external Pt100.  
page 136

**TER-3H**

-15 .. 45 °C  
(5 .. 113 °F)  
external NTC.  
page 136

**TER-3E**

0 .. 60 °C  
(32 .. 140 °F)  
external NTC.  
page 137

**TER-3F**

0 .. 60 °C  
(32 .. 140 °F)  
built-in NTC.  
page 137

**TER-7**

Monitoring heating of motor winding in range given by resistance of built-in PTC thermistor (1.8-3.3 kΩ), additional function (memory, reset), output contact 2x 8 A changeover/DPDT, supply: AC/DC 24-240 V.  
page 138

**TER-4**

Wide and accurate range of setting -40 .. 110 °C (-40 .. 230 °F) in ten ranges in one device, fine temperature setting, 2 inputs for NTC sensor, 2 outputs 16 A changeover/SPDT, additional function (memory, hysteresis, indication of faulty sensor). Supply: AC/DC 24-240 V (galv. separated).  
page 139

## Analog in increased protection

**TEV-1**

Thermostat with „dead zone“, independent adjustable range -20 .. 20 °C (-4 .. 68 °F), protection against freezing, water-proof type IP65.  
page 143

**TEV-2**

Thermostat for regulation of heating (cooling), adjustable range -20 .. 20 °C (-4 .. 68 °F), external sensor NTC, output contact 16 A changeover/SPDT.  
page 144

**TEV-3**

Thermostat for regulation of heating (cooling), adjustable range 5 .. 35 °C (41 .. 149 °F), external sensor NTC, output contact 16 A, control potentiometer and indication on panel.  
page 144

**TEV-4**

Single exterior thermostat for monitoring and regulation of temperature in demanding environments. Temperature range: -30 .. 60 °C (22 .. 140 °F)  
page 145

## Digital

**TER-9**

2 temperature inputs, 2 outputs 8 A changeover/SPDT, 6 functions, built-in time switch clock, LCD with back light, galvanically sep. supply voltage AC 230 V or AC/DC 24 V, 2-MODULE. Temperature range: -40 .. 110 °C (-40 .. 230 °F).  
page 141

## Hygrostat

**RHV-1**

Hygro-thermostat for humidity monitoring and regulation in range 0 - 90% RH.  
page 147

## Thermovalve

**ATV-1**

Energy-saving digital thermostat for radiators, with temperature range 8 .. 28 °C (48 .. 82 °F).  
page 148

## Hygro-thermostat

**RHT-1**

Hygro-thermostat for temperature monitoring and regulation in range 0 .. 60 °C (32 .. 140 °F) and relative humidity monitoring and regulation in range 50 - 90 %.  
page 146

## Accessories

**Telva-2**

It is an appropriate control unit for a wide range of thermostatic valves.  
page 149

**TC, TZ, Pt100**

External temperature sensors for thermostats in lengths 3m, 6m, 12m (9.9', 19.7', 39.4')  
TC/TZ: thermistor NTC 12 kΩ/25 °C (77 °F)  
Pt: element Pt100 (only TER-3G).  
page 150

Type	Design	Type		Sensor			Supply				Temperature range	Hysteresis	Relative humidity	Description	Page
		Analog	Digital	Built-in	External	Type	AC 230V	AC 24V	AC/DC 24 - 240V	Galv. separated					
TER-3A	1M-DIN	●	x	x	●	NTC	x	x	●	x	-30 .. 10 °C (-22 .. 50 °F)	0.5 .. 10 °C (32.9 .. 41 °F)	x	Single thermostat into a switchboard with external sensor for temperature in cooling and against freezing.	136
TER-3B	1M-DIN	●	x	x	●	NTC	x	x	●	x	0 .. 40 °C (32 .. 104 °F)	0.5 .. 5 °C (32.9 .. 41 °F)	x	Single thermostat into a switchboards with external sensor for sensing room and operational temperature.	
TER-3C	1M-DIN	●	x	x	●	NTC	x	x	●	x	+30 .. 70 °C (86 .. 158 °F)	0.5 .. 5 °C (32.9 .. 41 °F)	x	Single thermostat into a switchboards with external sensor for sensing temperature in devices (overheating,...).	
TER-3D	1M-DIN	●	x	x	●	NTC	x	x	●	x	0 .. 60 °C (32 .. 140 °F)	0.5 .. 5 °C (32.9 .. 41 °F)	x	Single thermostat into a switchboard with external sensor for sensing operational temperature of machines and devices.	
TER-3E	1M-DIN	●	x	x	●	NTC	x	x	●	x	0 .. 60 °C (32 .. 140 °F)	1 °C (34 °F)	x	As TER-3D but with fixed hysteresis.	137
TER-3F	1M-DIN	●	x	●	x	NTC	x	x	●	x	0 .. 60 °C (32 .. 113 °F)	1 °C (34 °F)	x	Single thermostat into a switchboard with in-built sensor, monitors operational temperature in a switchboard.	
TER-3G	1M-DIN	●	x	x	●	Pt100	x	x	●	x	0 .. 60 °C (32 .. 140 °F)	0.5 .. 5 °C (32.9 .. 37 °F)	x	As TER-3D but with input for sensor Pt100.	136
TER-3H	1M-DIN	●	x	x	●	NTC	x	x	●	x	-15 .. 45 °C (5 .. 113 °F)	0.5 .. 5 °C (32.9 .. 41 °F)	x	As TER-3A but with a different temperature range - for cooling and heating.	
TER-7	1M-DIN	●	x	x	●	PTC	x	x	●	x	x	Resistance 1.8 - 3.3 kΩ	x	Thermistor relay for protection of motor overheating, input designated for sensor PTC in-built in motor winding.	138
TER-4	3M-DIN	●	x	x	● (2x)	NTC	x	x	●	●	-40 .. 110 °C (-40 .. 230 °F)	0.5 .. 2.5 °C (32.9 .. 37 °F)	x	Two-state thermostat (2 inputs, 2 outputs), two independent or dependent thermostats, accurate setting, wide temperature range.	139
TEV-1	IP65 box	●	x	x	●	NTC	●	x	x	x	-20 .. 20 °C (-4 .. 68 °F)	1.5 °C (35 °F)	x	Thermostat with "dead zone", control of heating and protection against freezing, box for outdoor use with IP65.	143
TEV-2	IP65 box	●	x	x	●	NTC	●	x	x	x	-20 .. 20 °C (-4 .. 68 °F)	1.5 °C (35 °F)	x	Single thermostat for regulation of heating, short sensor is a part of this device, protection degree IP65.	144
TEV-3	IP65 box	●	x	x	●	NTC	●	x	x	x	5 .. 35 °C (41 .. 149 °F)	1.5 °C (35 °F)	x	As TEV-2 but potentiometer and indication are placed on front panel.	144
TEV-4	IP65 box	x	x	x	●	NTC	●	x	x	x	-30 .. 65 °C (-22 .. 149 °F)	0.5/1.5/4 °C (32.9/35/39 °F)	x	Single exteriors thermostat for monitoring and regulation of temperature in demanding environments.	145
TER-9	2M-DIN	x	●	x	● (2x)	NTC	●	●	x	●	-40 .. 110 °C (-40 .. 230 °F)	0.5 .. 5 °C (32.9 .. 41 °F)	x	Multifunction (6thermo functions) digital thermostat with in-built time switch clock, 2 inputs/2 outputs.	141
ATV-1	valve	x	●	●	x	-	x	x	x	x	8 .. 28 °C (46 .. 82 °F)	x	x	Thermostatic direction valves, temperature regulation +8 .. +28 °C (46 .. 82 °F).	148
RHT-1	1M-DIN	●	x	●	x	-	x	x	●	x	0 .. 60 °C (32 .. 140 °F)	H - 4 % T - 2.5 °C (36.5 °F)	50 - 90 %	Hygro-thermostat for temperature monitoring and regulation in range 0 .. +60 °C (32 .. 140 °F) and relative humidity in range 50 .. 90 %.	146
RHV-1	IP65	●	x	●	x	-	x	x	x	x	-30 .. 60 °C (-22 .. 140 °F)	2%, 3%, 4%	0 - 30 % 30 - 60 % 60 - 90 %	Hygrostat for humidity monitoring and regulation in range 0 .. 90 % RH.	147



EAN code  
 TER-3A: 8595188138390  
 TER-3B: 8595188138406  
 TER-3C: 8595188138413  
 TER-3D: 8595188138420  
 TER-3G: 8595188138451  
 TER-3H: 8595188138468

Technical parameters		TER-3	
Function:	single level		
Supply terminals:	A1-A2		
Voltage range:	AC/DC 24 - 240 V (galvanically unseparated) (AC 50-60 Hz)		
Burden:	max. 2 VA/1 W		
Max. dissipated power (Un + terminals):	2.5 W		
Supply voltage tolerance:	-15 %; + 10 %		
Measuring circuit			
Measuring terminals:	T1 - T1		
Temperature range (according to product type sensitivity):	TER-3A: 30 .. 10 °C (-22 .. 50 °F)	TER-3D 0 .. 60 °C (32 .. 140 °F)	
	TER-3B: 0 .. 40 °C (32 .. 104 °F)	TER-3G 0 .. 60 °C (32 .. 140 °F)	
	TER-3C: 30 .. 70 °C (86 .. 158 °F)	TER-3H -15 .. 45 °C (5 .. 113 °F)	
Hysteresis:	adjustable in range 0.5 .. 5 °C/0.9 .. 9 °F		
Sensor:	external, thermistor NTC, except for TER-3G (Pt100)		
Sensor fault indication (short circuit/disconnect):	flashing red LED		
Accuracy			
Setting accuracy (mech.):	5 %		
Switching difference:	0.5 °C/0.9 °F		
Temperature dependence:	< 0.1 %/°C (< 0.1 %/°F)		
Output			
Number of contacts:	1x NO-SPST (AgSnO <sub>2</sub> )		
Current rating:	16 A/AC1, 10 A/24 V DC		
Breaking capacity:	4000 VA/AC1, 300 W/DC		
Switching voltage:	250 V AC/24 V DC		
Output indication:	red LED		
Mechanical life:	10.000.000 ops.		
Electrical life (AC1):	100.000 ops.		
Other information			
Operating temperature:	-20 .. 55 °C (-4 .. 131 °F)		
Storage temperature:	-30 .. 70 °C (-22 .. 158 °F)		
Dielectrical strength:	2.5 kV (supply - output)		
Operating position:	any		
Mounting:	DIN rail EN 60715		
Protection degree:	IP40 from front panel/IP10 terminals		
Oversvoltage category:	III.		
Pollution degree:	2		
Max. cable size (mm <sup>2</sup> ):	solid wire max. 2x 2.5 or 1x 4 with sleeve max. 1x 2.5 or 2x 1.5 (AWG 12)		
Dimensions:	90 x 17.6 x 64 mm (3.5" x 0.7" x 2.5")		
Weight:	64 g (2.3 oz.); TER-3G: 68 g (2.4 oz.)		
Standards:	EN 60255-1, EN 60255-26, EN 60255-27, IEC 60730-2-9		

#### Example of an order

Always specify the type of thermostat (TER-3A, TER-3B .. or TER-3H) in the order according to the required temperature range.

- Single thermostat for temperature monitoring and regulation in range -30 °C to +70 °C (-22 °F to 158 °F) in six ranges.
- It can be used for monitoring temperature e.g. in switchboards, heating systems, cooling systems, liquids, radiators, motors, devices, open spaces, etc.
- Possibility to set function "heating"/"cooling".
- Adjustable hysteresis (sensitivity), switching by potentiometer in range 0.5 to 5 °C (0.9 to 9 °F).
- Choice of external temperature sensors with double insulation in standard lengths 3, 6 and 12 m (9.8', 19.7' and 39.4').
- It is possible to place sensor directly on terminal block - for temperature monitoring in a switchboard or in its surroundings.
- Red LED indicates status of output, green LED indicates energization of the device.

#### Description

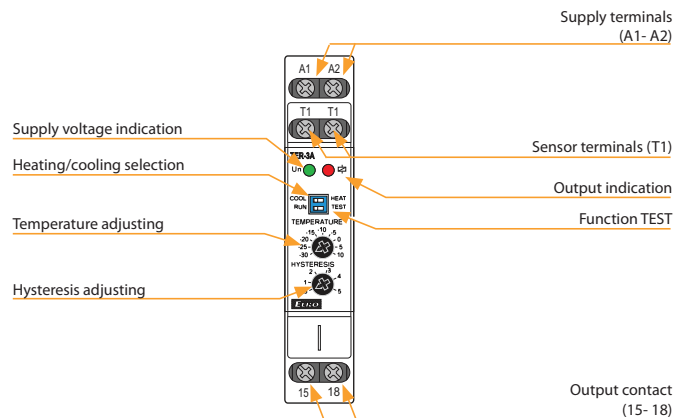

#### Function

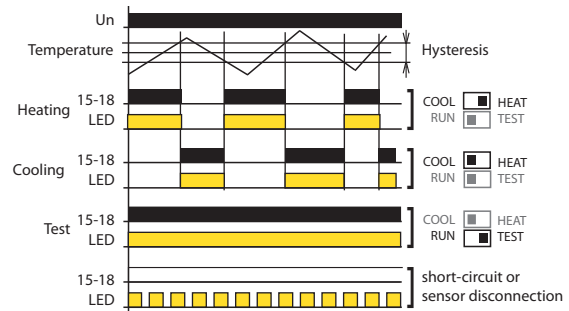

It is a single but practical thermostat with separated sensor for monitoring temperature. Device is placed in a switchboard and external sensor senses temperature of required space, object, or liquid. Supply is not galvanically separated from sensor. Sensor is double insulated. Maximal length of delivered sensor is 12 m/39.4'. device has in-built indication of sensor damage, which means that in case of short-circuit or disconnection red LED flashes. Thanks to adjustable hysteresis, it is advantageous to regulate width of the range and thus define sensitivity of load switching. Sensed temperature is decreased by set hysteresis. When installing it is necessary to keep in mind that hysteresis is increased by temperature gradient between sensor's jacket and thermistor.

#### Connection

#### Symbol

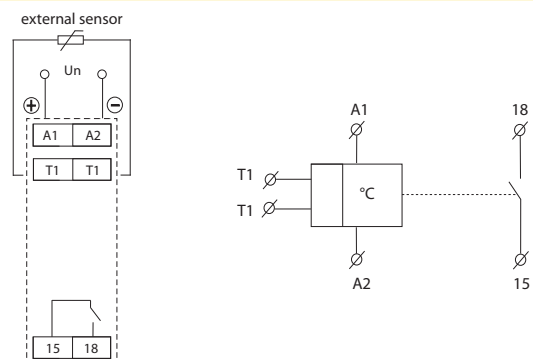



EAN code  
 TER-3E: 8595188138437  
 TER-3F: 8595188138444

Technical parameters	TER-3E	TER-3F
Function:	single level	
Supply terminals:	A1-A2	
Voltage range:	AC/DC 24 - 240 V (AC 50-60 Hz)	
Burden:	max. 2 VA/1 W	
Max. dissipated power (Un + terminals):	2.5 W	
Supply voltage tolerance:	-15 %; +10 %	
<b>Measuring circuit</b>		
Measuring terminals:	T1 - T1	x
Temperature range:	0 .. +60 °C/(32 .. 140 °F)	
Hysteresis:	fixed 1 °C/(1.8 °F)	
Sensor:	thermistor NTC	built-in
Sensor fault indic. (short-circuit/disconnection):	flashing red LED	
<b>Accuracy</b>		
Setting accuracy (mech.):	5 %	
Switching difference:	0.5 °C (0.9 °F)	
Temperature dependence:	< 0.1 %/°C (°F)	
<b>Output</b>		
Number of contacts:	1x NO - SPST (AgSnO <sub>2</sub> )	
Current rating:	16 A/AC1, 10 A/24 V DC	
Breaking capacity:	4000 VA/AC1, 300 W/DC	
Switching voltage:	250 V AC/24 V DC	
Output indication:	red LED	
Mechanical life:	10.000.000 ops.	
Electrical life (AC1):	100.000 ops.	
<b>Other information</b>		
Operating temperature:	-20 .. 55 °C (-4 .. 131 °F)	
Storage temperature:	-30 .. 70 °C (-22 .. 158 °F)	
Dielectrical strength:	2.5 kV (supply - output)	
Operating position:	any	
Operating position:	DIN rail EN 60715	
Mounting:	IP40 from front panel/IP10 terminals	
Protection degree:	III.	
Overvoltage category:	2	
Pollution degree:	solid wire max. 2x 2.5 or 1x 4	
Max. cable size (mm <sup>2</sup> ):	with sleeve max. 1x 2.5 or 2x 1.5 (AWG 12) 90 x 17.6 x 64 mm (3.5" x 0.7" x 2.5")	
Dimensions:	90 x 17.6 x 64 mm	
Weight:	64 g (2.3 oz.)	60 g (2.1 oz.)
Standards:	EN 60255-1, EN 60255-26, EN 60255-27, IEC 60730-2-9	

**Example of an order**

Please specify a type of thermostat in your order (TER-3E, TER-3F).

- Single thermostat for temperature monitoring and regulation in range 0 .. +60 °C (32 .. 140 °F).
- It can be used for temperature monitoring e.g. in switchboards, heating systems, liquids, radiators, motors, devices, open spaces, etc.
- Fixed hysteresis at 1 °C/(1.8 °F).
- **TER-3E:** choice of external temperature sensors with double insulation in standard lengths 3 (9.8'), 6 (19.7') and 12 m (39.4').
- **TER-3F:** sensor is a part of device, serves for monitoring temperature in a switchboard.

**Description**

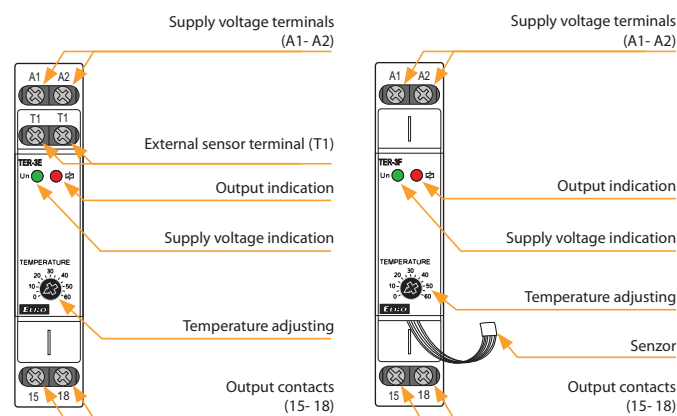

**Function**

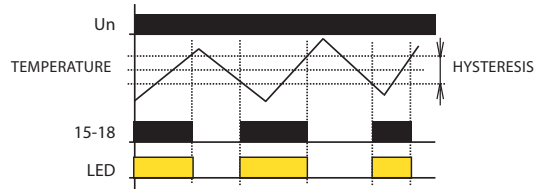

It is a single thermostat for temperature monitoring with separated sensor (except for TER-3F). Device is located in a switchboard and external sensor senses temperature of required space, object or liquid. Supply is not galvanically separated from sensor but sensor is double insulated. Maximal length of sensor cable is 12 m (39.4'). Temperature sensing is decreased by set hysteresis. When installing it is necessary to keep in mind that hysteresis is increased by temperature gradient between sensor's jacket and thermistor.

**Connection**

**Symbol**

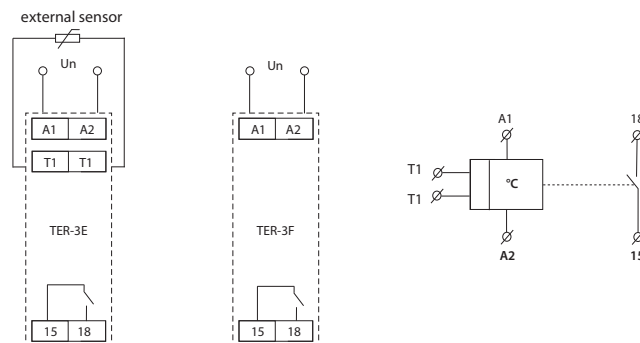



EAN code  
TER-7: 8595188137164

Technical parameters		TER-7
Function:	monitoring temperature of motor winding	
Supply terminals:	A1-A2	
Voltage range:	AC/DC 24 - 240 V (AC 50-60 Hz)	
Burden:	max. 2 VA/1 W	
Max. dissipated power (Un + terminals):	2.5 W	
Supply voltage tolerance:	-15 %; +10 %	
Measuring circuit		
Measuring terminals:	Ta-Tb	
Cold sensor resistance:	50 Ω - 1.5 kΩ	
Upper level:	3.3 kΩ	
Bottom level:	1.8 kΩ	
Sensor:	PTC temperature of motor winding	
Sensor failure indication:	blinking red LED	
Accuracy		
Accuracy in repetition:	< 5 %	
Switching difference:	± 5 %	
Temperature dependence:	< 0.1 %/°C	
Output		
Number of contacts:	2x changeover/DPDT (AgNi/Silver Alloy)	
Current rating:	8 A/AC1; 1/2 HP 240 Vac; PD. B300	
Breaking capacity:	2000 VA/AC1, 192 W/DC	
Inrush current:	10 A/< 3 s	
Switching voltage:	250 V AC/24 V DC	
Mechanical life:	30.000.000 ops.	
Electrical life (resistive):	100.000 ops.	
Other information		
Operating temperature:	-20 .. 55 °C (-4 .. 131 °F)	
Storage temperature:	-30 .. 70 °C (-22 .. 158 °F)	
Dielectrical strength:	4 kV (supply - output)	
Operating position:	any	
Mounting:	DIN rail EN 60715	
Protection degree:	IP40 from front panel/IP20 terminals	
Oversvoltage category:	III.	
Pollution degree:	2	
Max. cable size (mm <sup>2</sup> ):	solid wire max. 1x 2.5 or 2x 1.5/ with sleeve max. 1x 2.5 (AWG 12)	
Dimensions:	90 x 17.6 x 64 mm (3.5" x 0.7" x 2.5")	
Weight:	71 g (2.5 oz.)	
Standards:	EN 60255-1, EN 60255-26, EN 60255-27, IEC 60730-2-9	

#### Note

Sensors could be in series in abide with conditions in technical specification - switching limits.

Warning:  
In case of supply from the main, neutral wire must be connected to terminal A2!

- It monitors motor coil temperature.
- Fixed levels of switching.
- PTC sensor is used for sensing, it is in-built in motor winding by its manufacturer or there is used an external PTC sensor.
- MEMORY function - relay is blocked in an error state until until operator intervention (press RESET button).
- RESET of faulty state:
  - a) button on the front panel
  - b) by external contact (remote by two wires).
- Terminals of sensor are galvanically separated, they can be shorted out by terminal PE without damaging the device.
- In case device is supplied from network, neutral wire must be connected to terminal A2.

#### Description

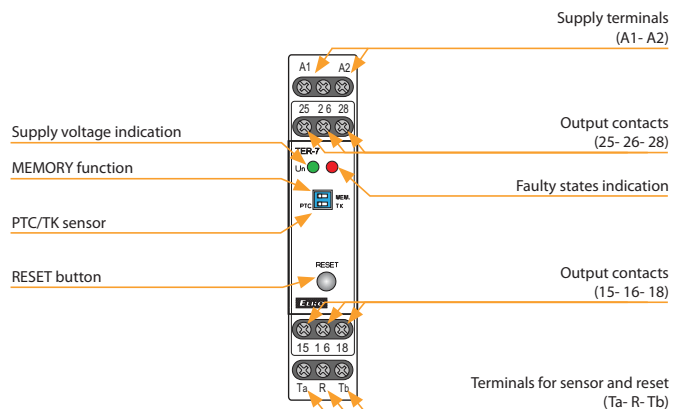

#### Function

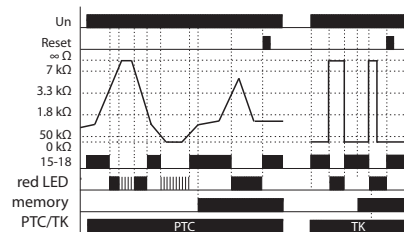

The device controls temperature of motor winding with PTC thermistor which is mostly placed in motor winding or very close to it. Resistance of PTC thermistor run to max 1.5 kΩ in cold stage. By temperature increase the resistance goes strongly up and by overrun the limit of 3.3 kΩ the contact of output relay switch off - mostly contactor controlling a motor. By temperature decrease and thereby decrease of thermistor resistance under 1.8 kΩ the output contact of relay again switches on. The relay has function "Control of sensor fault". This controls interruption or disconnection of sensor. When switch is in position "TK" monitoring of faulty sensor is not functional - it is possible to connect bimetal sensor with only 2 states: ON or OFF. The device can work with bi-metal sensor in this position. Other safety unit is function "Memory". By temperature overrun (and output switches off) the output is hold in faulty stage until service hit. This bring the relay to normal stage (with RESET button) on front panel or by external contact (remote).

#### Connection

#### Symbol

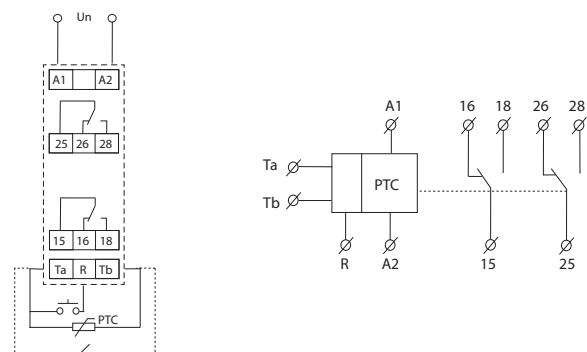



EAN code  
TER-4/UNI: 8595188185332

Technical parameters		TER-4
Number of functions:	4	
Supply terminals:	A1-A2	
Supply voltage:	AC/DC 24 – 240 V (AC 50-60 Hz) galvanically isolated	
Consumption (max.):	3 VA/1 W	
Supply voltage tolerance:	-15 %; +10 %	
Measuring circuit		
Measuring terminals:	T1-T1 & T2-T2	
Rough temperature ranges: (selectable by rotary switch)	-40 .. -25 °C (-40 .. -13 °F) -25 .. -10 °C (-13 .. 14 °F) -10 .. +5 °C (14 .. 41 °F) +5 .. +20 °C (41 .. 68 °F) +20 .. +35 °C (68 .. 95 °F)	+35 .. +50 °C (95 .. 122 °F) +50 .. +65 °C (122 .. 149 °F) +65 .. +80 °C (149 .. 176 °F) +80 .. +95 °C (176 .. 203 °F) +95 .. +110 °C (203 .. 230 °F)
Fine temperature setting:	0 – 15 °C, within the selected range	
Hysteresis (sensitivity) for T1:	optional, 0.5 or 2.5 °C (by DIP switch)	
Hysteresis (sensitivity) for T2:	optional, 0.5 or 2.5 °C (by DIP switch)	
Sensor:	thermistor NTC 12 kΩ/25 °C (°F)	
Sensor fault indication:	yellow LED lights up + red LED flashing	
Accuracy		
Setting accuracy (mech.):	5 %	
Temperature dependence:	< 0.1 %/°C	
Output		
Contact type:	2x changeover/SPDT (AgNi)	
Current rating:	16 A/AC1; 1 HP 240 Vac, 1/2 HP 120 Vac; PD. B300	
Breaking capacity:	4000 VA/AC1, 384 W/DC1	
Inrush current:	30 A/< 3 s	
Switching voltage:	250 V AC/24 V DC	
Power dissipation (max.):	2.4 W	
Mechanical life:	10.000.000 ops.	
Electrical life (AC1):	100.000 ops.	
Other information		
Operating temperature:	-20 .. +55 °C (-4 .. 131 °F)	
Storage temperature:	-30 .. +70 °C (-22 .. 158 °F)	
Dielectric strength:		
supply – output	AC 4 kV	
output 1 – output 2	AC 4 kV	
Operating position:	any	
Mounting:	DIN rail EN 60715	
Protection degree:	IP40 front panel / IP20 terminals	
Overvoltage category:	III.	
Pollution degree:	2	
Cross-wire section – solid/ stranded with ferrule (mm²):	max. 1x 2.5, 2x 1.5/ max. 1x 2.5 (AWG 14)	
Dimensions:	90 x 52 x 66 mm (3.5" x 2.05" x 2.6")	
Weight:	147 g (5.2 oz)	
Standards:	EN 60255-1, EN 60255-26, EN 60255-27, EN 60947-1	

- Used for temperature monitoring in switchboards, heating or cooling systems, engines, liquids, open spaces, etc.
- Double thermostat for temperature monitoring and regulation over a wide range.
- Rough and fine temperature setting for each thermostat.
- Galvanically isolated power supply AC/DC 24 – 240 V.
- 2x input for temperature sensor NTC 12 k/25 °C.
- Setting the independent or dependent function of thermostats.
- Selection of heating/cooling function.
- Selectable hysteresis (sensitivity) of switching.
- Two output contacts (separate for each thermostat).

Description

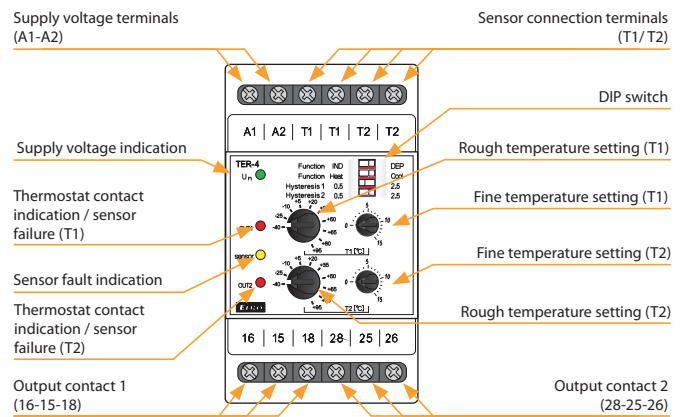

Description of DIP switch

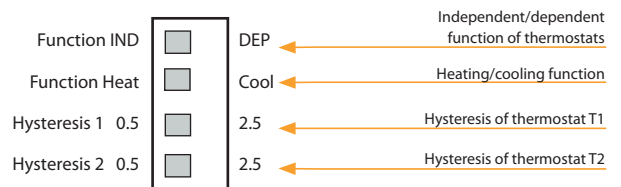

Connection

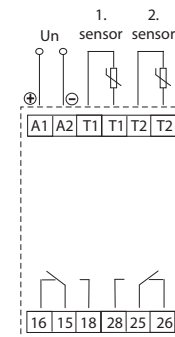

Symbol

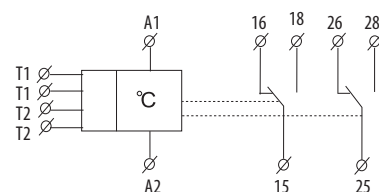



**Function**

Each thermostat has its own sensor, rough and fine temperature setting, selectable hysteresis and its separated output contact. The desired temperature is set as the sum value of the selected rough and fine temperature setting.

Example: Required temperature ..... +25 °C (77 °F)  
 Rough setting ..... +20 °C (68 °F)  
 Fine setting ..... 5 °C (41 °F)

The device monitors the fault state of each sensor (short circuit or interruption) - if a sensor malfunction occurs, the yellow LED lights up and the corresponding red LED flashes. The respective output contact is opened in the event of a failure.

The device can also be operated as a simple thermostat (with one sensor). In this case, it is necessary to connect a 10 kΩ resistor instead of a sensor to the unused input (included in the product package).

**Independent function of thermostats**

The device acts as two separate simple thermostats.

**Dependent function of thermostats**

Thermostats are connected "in series" - i.e. thermostat T1 is blocked by thermostat T2. This can be used e.g. so that thermostat T1 is operational and thermostat T2 is interlocking (emergency - e.g. when the device overheats).

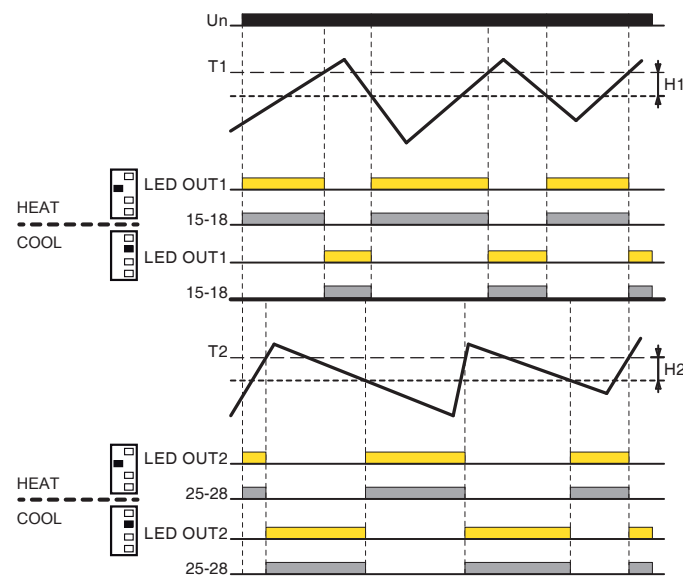

Graphs legend:  
 T1(2) - set thermostats temperature  
 H1(2) - thermostats hysteresis

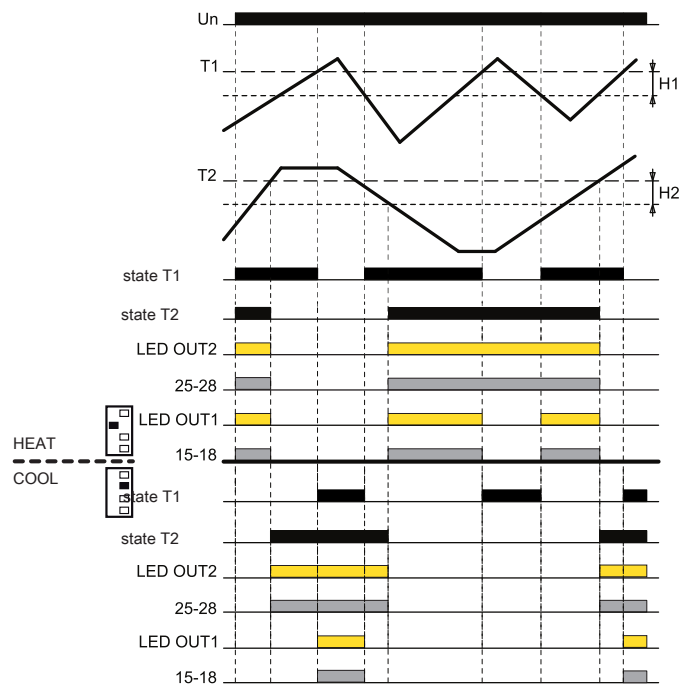



EAN code  
 TER-9 /230V: 8595188124478  
 TER-9 /24V: 8595188129190

Technical parameters		TER-9
<b>Supply</b>		
Number of function:	6	
Supply terminals:	A1 - A2	
Voltage range:	AC 230 V (AC 50-60 Hz) galvanically separated, AC/DC 24 V galvanically unseparated	
Burden:	max. 4 VA/0.5 W	
Max. dissipated power (Un + terminals):	3 W	
Supply voltage tolerance:	-15 %; +10 %	
Type backup battery:	CR 2032 (3 V)	
<b>Measuring circuit</b>		
Measuring terminals:	T1-T1 and T2-T2	
Temperature range:	-40 .. +110 °C (-40 .. +230 °F)	
Hysteresis (sensitivity):	in an adjustable range 0.5 to 5 °C (0.9 to 9 °F)	
Difference temperature:	adjustable 1 to 50 °C (34 to 122 °F)	
Sensor:	thermistor NTC 12 kΩ at 25 °C (77 °F)	
Sensor failure indication:	displayed on the LCD	
<b>Accuracy</b>		
Measuring accuracy:	5 %	
Repeat accuracy:	< 0.5 °C (0.9 °F)	
Temperature dependance:	< 0.1 %/°C (°F)	
<b>Output</b>		
Number of contacts:	1x changeover for each output/SPDT, (AgNi)	
Current rating:	8 A/AC1; 1/3 HP 240 Vac, 1/4 HP 120 Vac; PD. B300	
Max. breaking capacity:	2000 VA/AC1, 240 W/DC	
Switching voltage:	250 V AC/30 V DC	
Output indication:	symbol ON/OFF	
Mechanical life:	60.000.000 ops.	
Electrical life (AC1):	150.000 ops.	
<b>Time circuit</b>		
Power back-up:	up to 3 year	
Accuracy:	max. ±1 s per day, at 23°C (73.4 °F)	
Min. switching interval:	1 min	
Data stored for:	min. 10 years	
<b>Program circuit</b>		
Number of memory places:	100	
Program:	daily, weekly, yearly	
Data readout:	LCD display, with back light	
<b>Other information</b>		
Operating temperature:	-10 .. 55 °C (14 .. 131 °F)	
Storage temperature:	-30 .. 70 °C (-22 .. 158 °F)	
Dielectrical strength:	4 kV (power supply - output)	
Operating position:	any	
Mounting:	DIN rail EN 60715	
Protection degree:	IP20 terminals, IP40 from front panel	
Overvoltage category:	III.	
Pollution degree:	2	
Max. cable size (mm <sup>2</sup> ):	solid wire max. 1x2.5 or 2x1.5/ with sleeve max. 1x2.5 (AWG 12)	
Dimensions:	90 x 35 x 64 mm (3.5 x 1.4 x 2.5")	
Weight:	150 g/5.3 oz. (230 V)   113 g/4 oz. (24 V)	
Standards:	EN 61812-1; EN 60255-1, EN 60255-26, EN 60255-27, IEC 60730-2-9	

- Digital thermostat with 6 functions and built-in time switch clock with day, week and year program. You can also limit temperature functions and courses this way in real time.
- Complex control of home and water heating, solar heating, etc.
- Two thermostats in one, two temperature inputs, two outputs with dry contact.
- Maximum universal and variable thermostat including all ordinary thermostat functions.
- Functions: two independent thermostats, dependent thermostat, differential thermostat, two level thermostat, zone-based thermostat, dead zone thermostat.
- Program setting of output functions, calibration of sensors according to reference temperature (offset).
- The thermostat is subject to the digital clock programs.
- Wide operating range of temperature settings, the possibility of measuring in °C and °F.
- Clear display of set and measured data on a backlit LCD.
- Power supply: AC 230 V or 24 V AC/DC (based on type of device).
- The time switch clock has a battery backup, which retains data in case of a power outage (backup time is up to 3 years).
- Easy replacement of the backup battery through the plug-in module, no disassembling is required.
- Output contact 1x changeover/SPDT 8 A/250 V AC1 for each output.
- 2-MODULE, DIN rail mounting.

Device description

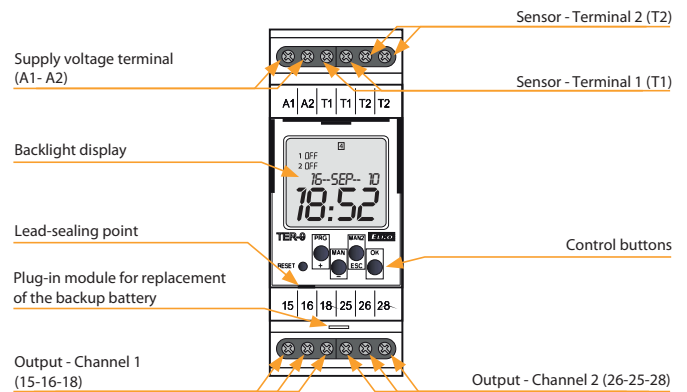

Description of visual elements on the display

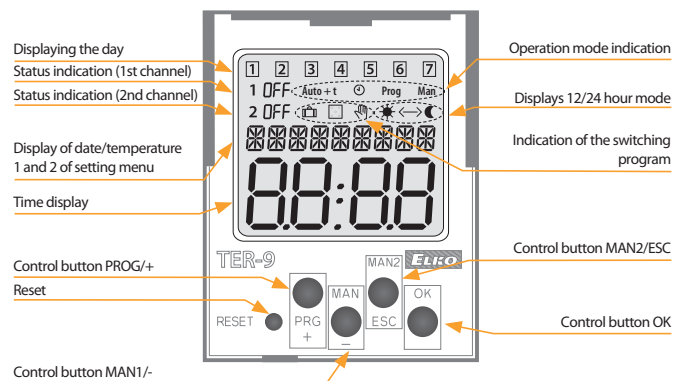

Connection

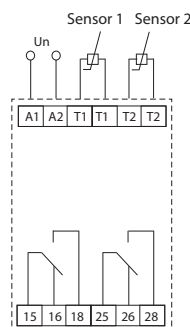

Symbol

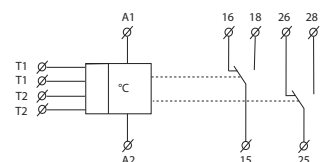

1. 2 independent single-stage thermostats

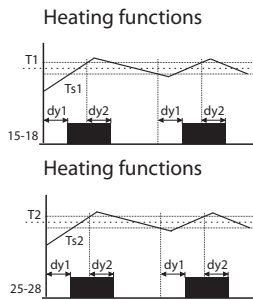

**Legend:**  
 Ts1 - real (measured) temperature 1  
 Ts2 - real (measured) temperature 2  
 T1 - adjusted temperature T1  
 T2 - adjusted temperature T2  
 H1 - adjusted hysteresis for T1  
 H2 - adjusted hysteresis for T2  
 dy1 - set switching delay of the output  
 dy2 - set delay on output breaking  
 15-18 output contact (for T1)  
 25-28 output contact (for T2)

Classic function of thermostat, output contact switched until adjusted temperature is reached. Hysteresis eliminates frequent switching - output oscillation.

2. Depending functions of 2 thermostats

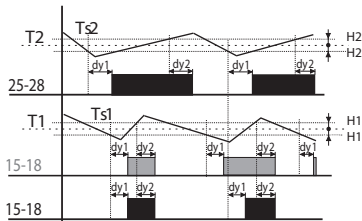

**Legend:**  
 Ts1 - real (measured) temperature 1  
 Ts2 - real (measured) temperature 2  
 T1 - adjusted temperature T1  
 T2 - adjusted temperature T2  
 H1 - adjusted hysteresis for T1  
 H2 - adjusted hysteresis for T2  
 dy1 - set switching delay of the output  
 dy2 - set delay on output breaking  
 25-28 output contact (for T2)  
 15-18 output contact (intersection T1 and T2)

Output 15 - 18 is closed, if temperature of both thermostats is below an adjusted level. When any thermostat reaches adjusted level, the contact 15 - 18 opens. Serial inner connection of thermostats (logic function AND).

3. Differential thermostat

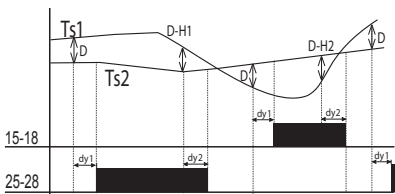

**Legend:**  
 Ts1 - real (measured) temperature T1  
 Ts2 - real (measured) temperature T2  
 D - adjusted difference  
 H1 - adjusted hysteresis for T1  
 H2 - adjusted hysteresis for T2  
 dy1 - set switching delay of the output  
 dy2 - set delay on output breaking  
 15-18 output contact (for T1)  
 25-28 output contact (for T2)

Switching of output corresponds with input, which has lower temperatures when difference is exceeded. Differential thermostat is used for keeping two identical temperature e.g. in heating systems (boiler and reservoir), solar systems (collector - reservoir, exchanger), water heating (water heater, water distribution)etc.

4. 2-stage thermostat

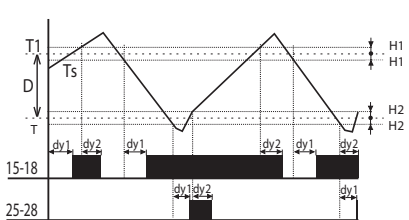

**Legend:**  
 Ts - real (measured) temperature  
 T1 - adjusted temperature  
 T = T1 - D  
 D - adjusted difference  
 H1 - adjusted hysteresis for T1  
 H2 - adjusted hysteresis for T  
 dy1 - set switching delay of the output  
 dy2 - set delay on output breaking  
 15-18 output contact  
 25-28 output contact

Typical example of use for two-stage thermostat is e.g. in boiler-room, where there are two boilers from which one is main and the other one is auxiliary. The main boiler is managed according to set temperature and auxiliary boiler is switched in case, temperature falls under set difference. Thus it helps to the main boiler in case, outside temperature dramatically falls. In the range of set difference (D) output 15-18 functions as normal thermostat to input 1 (type 1). In case temperature falls under set difference, second output switches too.

5. Thermostat with "WINDOW"

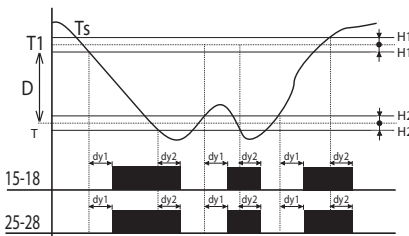

**Legend:**  
 Ts - real (measured) temperature  
 T1 - adjusted temperature  
 T = T1 - D  
 H1 - adjusted hysteresis for T1  
 H2 - adjusted hysteresis for T  
 dy1 - set switching delay of the output  
 dy2 - set delay on output breaking  
 15-18 output contact  
 25-28 output contact

Output is closed (heating) only if temperature is within adjusted range. If temperature is out of range, the contact opens. T is set as T1-D. The function is used for protection of gutters against freezing.

6. Thermostat with dead zone

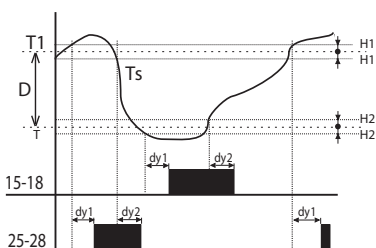

**Legend:**  
 Ts - real (measured) temperature  
 T1 - adjusted temperature  
 T = T1 - D  
 H1 - adjusted hysteresis for T1  
 H2 - adjusted hysteresis for T  
 dy1 - set switching delay of the output  
 dy2 - set delay on output breaking  
 15-18 output contact (heating)  
 25-28 output contact (cooling)

In case of thermostat with a „dead zone“, it is possible to set temperature T1 and a difference (respectively a width of dead zone D). If temperature is higher than T1, output contact of cooling switches ON; if the temperature gets below T1, the contact switches OFF. If the temperature gets below temperature T, the contact of heating switches ON and it switches OFF when temperature T is exceeded. This function can be used for example for automatic air warming and cooling in ventilation so the sit is always within the range T1 and T.



- Two-level thermostat with function "WINDOW" meaning that output is switched in case, the measured temperature is within set range (adjustable in range -20 až +20 °C/-4 °F to +68 °F).
- Used as protection against freezing (water-shoots, pavements, drives, pipes, etc.) heating is on, when temperature falls under set upper level (e.g. +5 °C/+41 °F) and off in case it falls under lower level (e.g. -10 °C/-50 °F, when heating is not able effectively operate).
- Thermostat is placed in water-proof box with IP65, which allows installation outside, with in-built sensor TZ-0.
- Thermostat status is indicated by LED (3 colours) under transparent cover.
- Function monitoring short-circuit and sensor disconnection (break).

EAN code  
TEV-1: 8595188129121

Technical parameters		TEV-1
Function:	two-level thermostat	
Supply terminals:	L - N	
Voltage range:	AC 230 V (50-60 Hz)	
Input:	max. 2.5 VA/0.5 W	
Max. dissipated power (Un + terminals):	3 W	
Tolerance of voltage range:	±15 %	
Measuring circuit		
Measuring terminals:	T - T	
Temperature ranges		
thermostat 1:	-20 .. 20°C (-4 .. 68 °F)	
thermostat 2:	-20 .. 20°C (-4 .. 68 °F)	
Hysteresis (sensitivity):	3°C (± 1.5 °C)/37.4 °F (± 34.7 °F)	
Sensor:	thermistor NTC 12 kΩ/25 °C (77 °F)	
Faulty sensor indication:	red LED flashing	
Accuracy		
Accuracy of settings (mech.):	5 %	
Dependance on temperature:	< 0.1 %/°C (°F)	
Output		
Number of contacts:	1x changeover/SPDT (AgNi/Silver Alloy)	
Current rating:	16 A/AC1; 1 HP 240 Vac, 1/2 HP 120 Vac; PD. B300	
Max. breaking capacity:	4000 VA/AC1, 384 W/DC	
Peak current:	30 A/< 3 s	
Switched voltage:	250 V AC	
Output indication:	LED	
Mechanical life:	10.000.000 ops.	
Electrical life:	100.000 ops.	
Other information		
Operation temperature:	-30 .. 50 °C (-22 ..140 °F)	
Operation position:	any	
Protection degree:	IP65	
Overvoltage category:	III.	
Pollution level:	2	
Max. cable size (mm²):	solid wire 2.5/ with sleeve 1.5 (AWG 12)	
Dimensions:	110 x 135 x 66 mm (4.33 "x 5.3 "x 6.6 ")	
Weight:	270 g (9.5 oz.)	
Standards:	EN 60255-1, EN 60255-26, EN 60255-27, IEC 60730-2-9	

Description

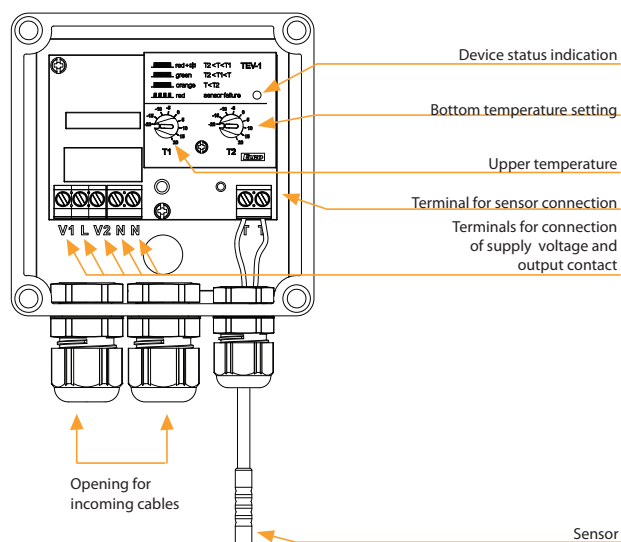

Function

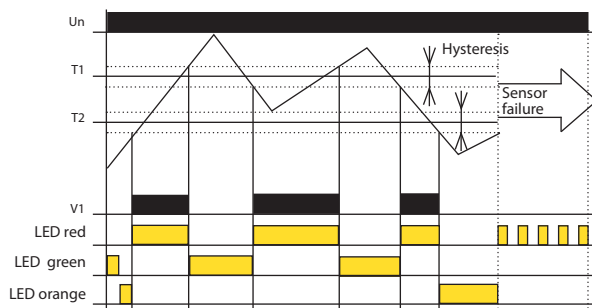

TEV-1 is a double thermostat designed for system of protection of roof water-shoots against freezing. The device is placed in a waterproof box (IP65), sensor with double insulation, which is a part of the device, senses ambient temperature. The device operates as zonal thermostat with independent setting of upper and bottom operational temperature. In case the ambient temperature is higher than T1 (upper temperature), thermostat switches heating of watershoots off (icing melts down). In case the ambient temperature is lower than T2 (bottom temperature), thermostat also switches heating off (to big freezing-heating cannot manage to melt the ice).

Connection

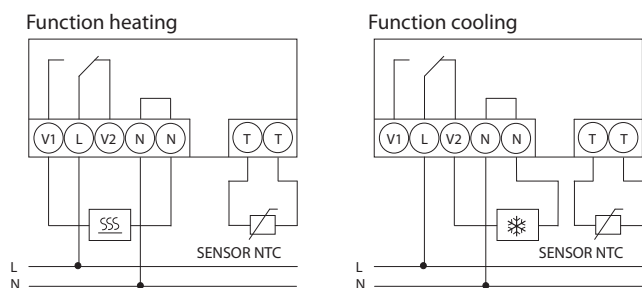

Symbol

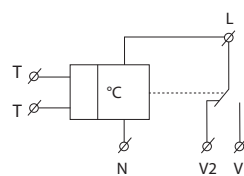

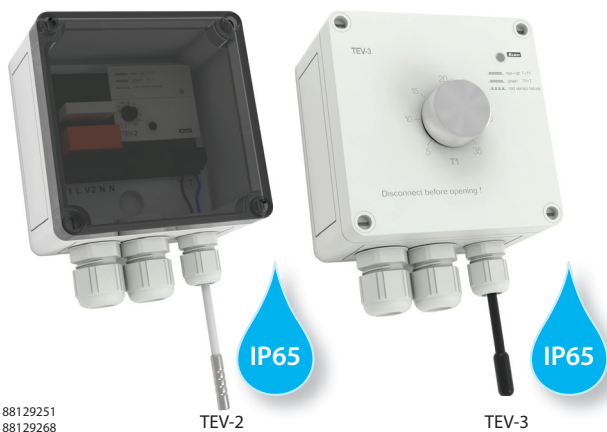

EAN code  
TEV-2: 8595188129251  
TEV-3: 8595188129268

Technical parameters	TEV-2	TEV-3
Function:	one-level thermostat	
Supply terminals:	L - N	
Voltage range:	AC 230 V (50-60 Hz)	
Input:	max. 2.5 VA/0.5 W	
Max. dissipated power:	3 W (Un + terminals)	
Tolerance of voltage range:	± 15 %	
<b>Measuring circuit</b>		
Measuring terminals:	T - T	
Temperature ranges:	-20 .. 20°C (-4 .. 68 °F)	5 .. 35°C (41 .. 95 °F)
Hysteresis (sensitivity):	3 °C (± 1.5 °C)/37.4 °F (± 34.7 °F)	
Sensor:	thermistor NTC 12 kΩ	
Faulty sensor indication:	red LED flashing	
<b>Accuracy</b>		
Accuracy of settings (mech.):	5 %	
Dependance on temperature:	< 0.1 %/°C (°F)	
<b>Output</b>		
Number of contacts:	1x changeover/SPDT (AgNi/Silver Alloy)	
Current rating:	16 A/AC1; 1 HP 240 Vac, 1/2 HP 120 Vac; PD. B300	
Max. breaking capacity:	4000 VA/AC1, 384 W/DC	
Peak current:	30 A/< 3 s	
Switched voltage:	250 V AC	
Output indication:	red LED	
Mechanical life:	10.000.000 ops.	
Electrical life (AC1):	100.000 ops.	
<b>Other information</b>		
Operation temperature:	-30 .. 50 °C (-22 .. 122°F)	
Operation position:	any	
Protection degree:	IP65	
Overvoltage category:	III.	
Polution level:	2	
Max. cable size (mm²):	solid wire 2.5/ with sleeve 1.5 (AWG 12)	
Dimensions:	110 x 135 x 66 mm (4.33"x 5.3"x 2.3")	
Weight:	270 g (9.5 oz.)	274 g (9.7 oz.)
Standards:	EN 60255-1, EN 60255-26, EN 60255-27, IEC 60730-2-9	

Connection

Function heating

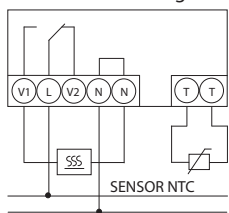

Function cooling

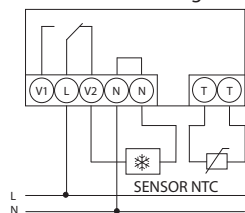

Symbol

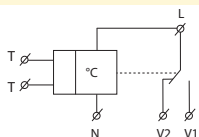

- Single thermostat with possibility of temperature management in adjustable range (it is possible to modify this range or make a special one on request).
- Used to regulate heating (or cooling) in demanding environments (outside, humidity, dustiness, etc.).
- Thermostat is placed in water-proof box with IP65 protection, which enables installation outside, with in-built sensor.
- TEV-2: control and indication elements are placed under transparent cover.
- TEV-3: control and indication elements are placed directly on the cover (for easy orientation and frequent change of temperature).
- Thermostat status is indicated by LED (2 colours).
- Function of monitoring sensor disconnection and short-circuit.

Description TEV-2 (without cover)

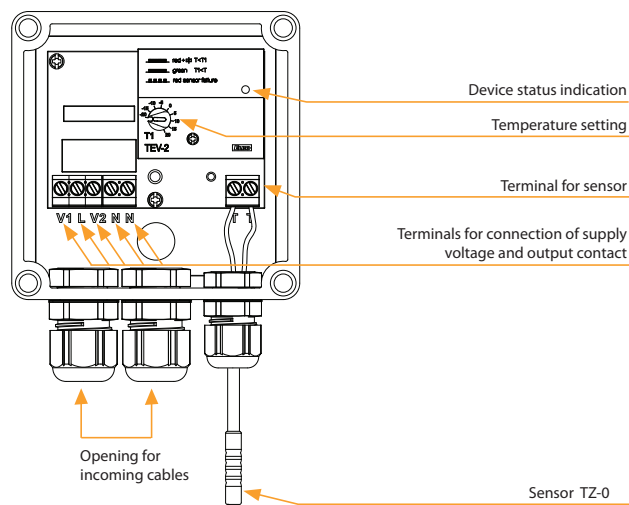

Description TEV-3 (cover)

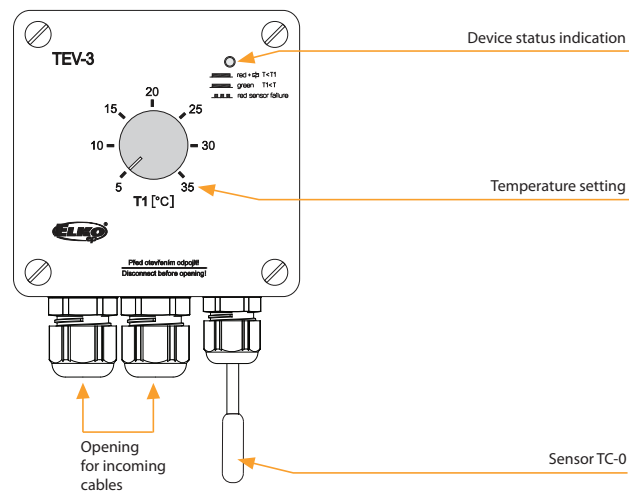

Function TEV-2,TEV-3

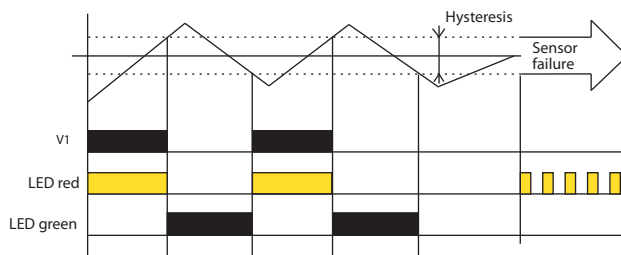

TEV-2 and TEV-3 are universal single thermostats for universal use. In case ambient temperature is higher than set temperature relay is open (function HEATING), for cooling function (opposite function) is possible to use NC contact of relay (V2).



EAN code  
TEV-4: 8595188140577

Technical parameters		TEV-4
<b>Supply</b>		
Supply terminals:	L - N	
Voltage range:	AC 230 V (50-60 Hz)	
Input (apparent / loss):	max. 6 VA/0.7 W	
Max. dissipated power (Un + terminals):	2.5 W	
Tolerance of voltage range:	- 15 % to +10 %	
<b>Function</b> setting by jumper J3		
Function - ❄️:	cooling	
Function - 🔥:	heating	
<b>Temperature setting</b> by jumper J2		
range 1:	-30 .. 0 °C (-22 .. 32 °F)	
range 2:	0 .. 30 °C (32 .. 86 °F)	
range 3:	30 .. 60 °C (86 .. 140 °F)	
Slight temperature setting:	potentiometer	
<b>Hysteresis</b> 0.5/1.5/4 °C (32.9/34.7/39.2 °F)		
Hysteresis setting:	by jumper J1	
<b>Output</b>		
Output contact:	1 x NO-SPST (AgSnO <sub>2</sub> )	
Current rating:	12 A/AC1	
Max. breaking capacity:	3000 VA/AC1, 384 W/DC	
Peak current:	30 A/< 3 s	
Switched voltage:	250 V AC/24 V DC	
Mechanical life:	30.000.000 ops.	
Electrical life:	100.000 ops.	
<b>Other information</b>		
Operation temperature:	-30 .. 65 °C (-22 .. 149 °F)	
Storing temperature:	-30 .. 70 °C (-22 .. 158 °F)	
Dielectrical strength:	4 kV (supply-output)	
Operation position:	sensor-side down	
Protection degree:	IP65	
Overvoltage category:	III.	
Pollution degree:	2	
Max. cable size (mm <sup>2</sup> ):	max.1x 2.5, max. 2x 1.5/ with sleeve max.1x 2.5 (AWG 12)	
Suggested power-supply cable:	CYKY 3x2.5 (CYKY 4x1.5)	
Dimensions:	153 x 62 x 34 mm (6" x 2.4" x 1")	
Weight:	123 g (4.3 oz.)	
Standards:	EN 60255-1, EN 60255-26, EN 60255-27, IEC 60730-2-9	

**Function**

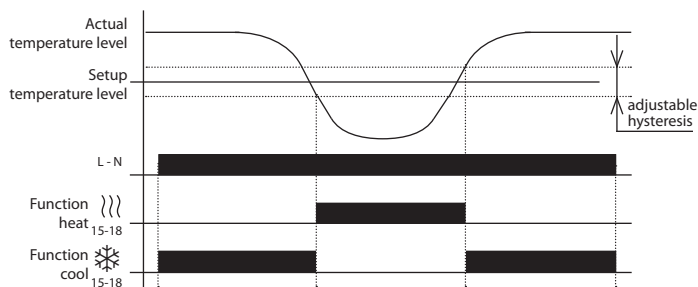

- Single point thermostat for monitoring and regulation of temperature in demanding environments (humid and contaminated, aggressive and defective, industrial workshops, washing rooms, green-houses, cellars and cooling boxes,...).
- External version in IP65, box for mounting on the wall.
- Built-in thermo-sensor is integrated in the device.
- Two functions adjustable by jumper: heating and cooling.
- 3 adjustable (by jumper) ranges of temperature, and fine adjustment through potentiometer.
- 3 adjustable (by jumper) levels of hysteresis.
- Potentialless NO-SPST contact 12 A AC1 switching.

**Description**

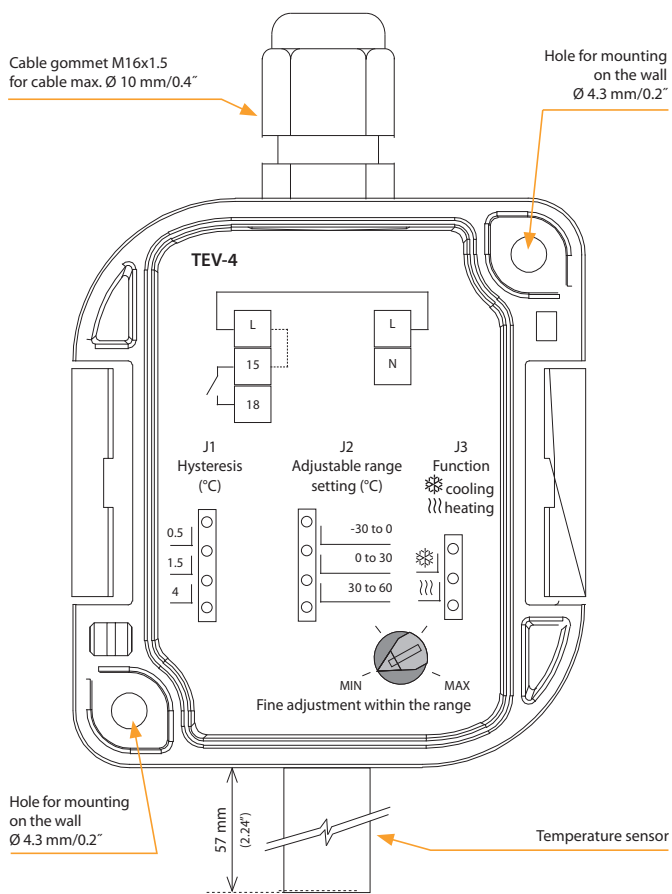

**Connection**

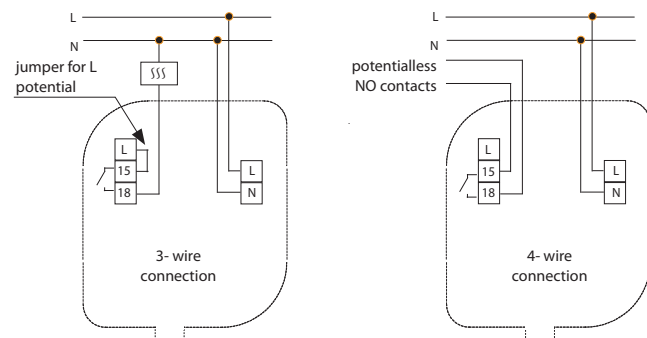

**Description of function**

Device is standardly supplied with jumper L-15 (3-wire connection). For the correct function of device is necessary sensor-side down device mounting.





EAN code  
RHT-1: 8595188137263

### Technical parameters RHT-1

Function:	hygro-thermostat
Supply terminals:	A1 - A2
Voltage range:	AC/DC 24 - 240 V (AC 50-60 Hz)
Input:	max. 1 VA/0.5 W
Max. dissipated power (Un + terminals):	2.5 W
Tolerance of voltage range:	-15 %; +10 %

### Measuring circuit

Temperature range:	0 .. 60 °C (32 .. 140 °F)
Humidity range:	50 - 90 %
Temperature hysteresis:	2.5 °C (4.5 °F)
Humidity hysteresis:	4 %
Sensor:	internal
Indication of sensor's fault:	red LED flashing

### Accuracy

Setting accuracy (mechanical):	5 %
Long-term stability of humidity:	typical < 0.8 %/year

### Output

Number of contacts:	1x NO-SPST (AgSnO <sub>2</sub> )
Current rating:	16 A/AC1, 10 A/24 V DC
Switched output:	4000 VA/AC1, 300 W/DC
Switched voltage:	250 V AC/24 V DC
Output indication:	red LED shines
Mechanical life:	10.000.000 ops.
Electrical life:	100.000 ops.

### Other information

Operational temperature:	-20 .. 60 °C (-4 .. 140 °F)
Storing temperature:	-30 .. 70 °C (-22 .. 158 °F)
Dielectrical strength:	2.5 kV (supply-output)
Operational position:	vertical, with correct orientation
Mounting:	DIN rail EN 60715
Protection degree:	IP40 from front panel, IP10 on terminals
Overvoltage category:	III.
Pollution degree:	2
Max. cable size (mm <sup>2</sup> ):	max. 2x 2.5, max. 1x 4 with sleeve max. 1x 2.5, max. 2x 1.5 (AWG 12)
Dimensions:	90 x 17.6 x 64 mm (3.5" x 0.7" x 2.5")
Weight:	63 g (2.2 oz.)
Standards:	EN 60255-1, EN 60255-26, EN 60255-27, IEC 60730-2-9

- Hygro-thermostat for temperature monitoring and regulation in range 0 °C to 60 °C (32 °F to 140 °F) and relative humidity monitoring and regulation in range 50 to 90 %.
- Possibility of setting of up to 8 conditions for contact switching and function permanently ON/OFF.
- Sensor is a part of the device - designated for measuring in switchboards.
- Function of sensor control (damage, disturbances,...).
- Fixed setting of temperature hysteresis at 2.5 °C (4.5 °F) and humidity at 4 %.

### Device description

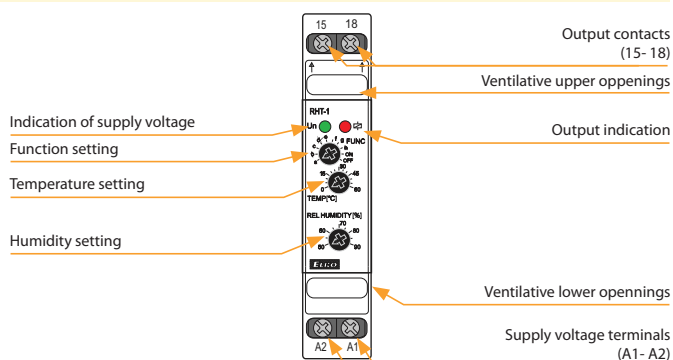

### Functions

Choice of function	Relay switched under the following conditions	
A	T > Tset	or RH > RHset
B	T < Tset	or RH > RHset
C	T > Tset	or RH < RHset
D	T < Tset	or RH < RHset
E	T < Tset	and RH < RHset
F	T > Tset	and RH < RHset
G	T < Tset	and RH > RHset
H	T > Tset	and RH > RHset
ON	relay permanently ON	
OFF	relay permanently OFF	

This device is designated for monitoring of parameters of environment (meaning temperature and relative humidity) in switchboards. It enables setting of eight conditions of contact closing and therefore it is usable for various types of load (e.g. fans, heating, air-conditioning, dehydrating units,...).

While installing it is necessary to take into account the fact that hysteresis rises by persistence of measured values between sensor and ambient environment.

The device is equipped by sensor fault detection. In case of sensor fault, exceeding allowed limits (for temperature -30 °C/-22 °F and +80 °C/176 °F; for humidity 5 % and 95 %) or in case of faulty internal communication higher than 50 % (due to e.g. high ambient disturbances) contact opens and sensor fault is indicated. Sensor fault doesn't have influence on function permanently ON or permanently OFF.

Note: In case the conditions for switching are not applied, relay is open.

### Symbol

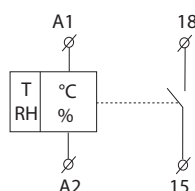

### Connection





EAN code  
RHV-1: 8595188140584

Technical parameters		RHV-1
<b>Supply</b>		
Supply terminals:	L - N	
Voltage range:	AC 230 V (50-60 Hz)	
Input (apparent/loss):	max. 6 VA/0.7 W	
Max. dissipated power:	2.5 W (Un + terminals)	
Input voltage range:	- 15 % to +10 %	
<b>Setting function</b> Setting function Jumper J3		
Function - :	moistening	
Function - :	drying	
<b>Set. the scale of relative humidity</b> Humidity setting Jumper J2		
range 1:	0 to 30 % RH	
range 2:	30 to 60 % RH	
range 3:	60 to 90 % RH	
Slight setting of relative humidity:	Relative Humidity Setting Potentiometer	
<b>Hysteresis</b> 2, 3, 4 % from setup rate		
Hysteresis setting:	Jumper J1	
<b>Output</b>		
Output contact:	1x NO-SPST (AgSnO <sub>2</sub> )	
Current rating:	12 A/AC1	
Switching output:	3000 VA/AC1, 384 W/DC	
Peak current:	30 A/< 3 s	
Switched voltage:	250 V AC/24 V DC	
Mechanical life:	30.000.000 ops.	
Electrical life:	100.000 ops.	
<b>Other information</b>		
Operation temperature:	-30 .. 60 °C (-22 ..140 °F)	
Storing temperature:	-30 .. 70 °C (-22 ..158 °F)	
Electrical strength:	4 kV (supply-output)	
Operation position:	sensor-side down	
Protection degree:	IP65	
Overvoltage category:	III.	
Pollution degree:	2	
Max. cable size (mm <sup>2</sup> ):	max. 1x 2.5, max. 2x 1.5/ with sleeve max. 1x 2.5 (AWG 12)	
Suggested power-supply cable:	CYKY 3x2.5 (CYKY 4x1.5)	
Dimensions:	153 x 62 x 34 mm (6" x 2.4" x 1.3")	
Weight:	124 g (4.4 oz.)	
Standards:	EN 60255-1, EN 60255-26, EN 60255-27, IEC 60730-2-9	

**Function**

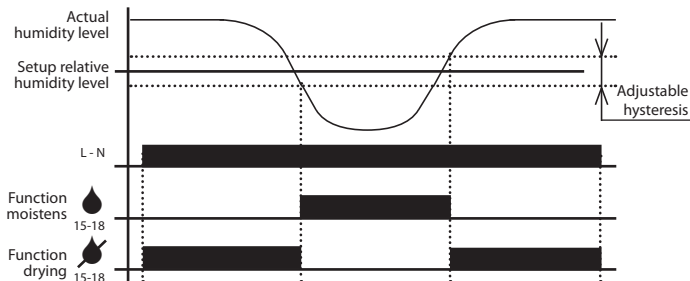

- Single hygrostat is used for regulation of humidity in harsh environments (washdown, greenhouse, refrigeration).
- External version in IP65, box for mounting on the wall.
- Built-in hygro-sensor is integrated in the device.
- Two functions adjustable by jumper: moistening and drying.
- 3 adjustable (by jumper) levels of hysteresis.

**Description**

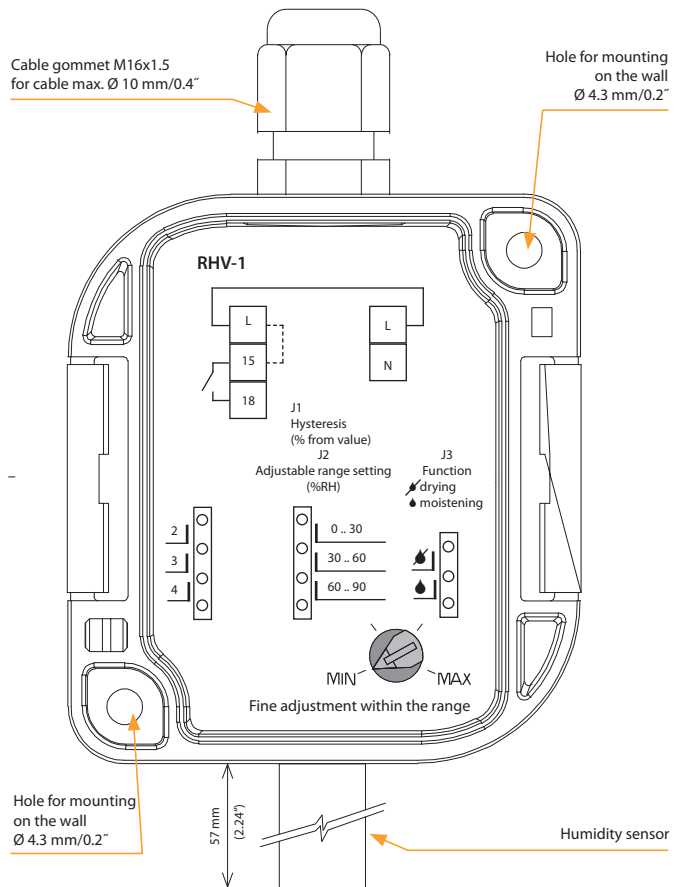

**Connection**

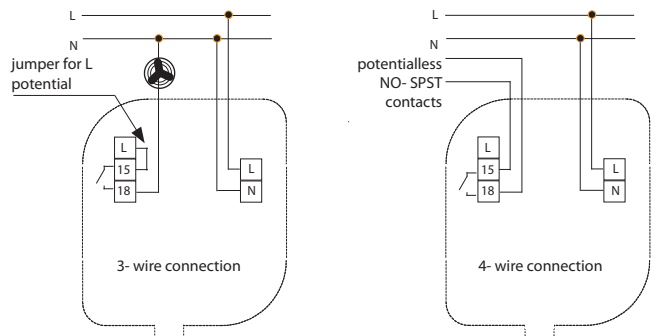

**Description of function**

Device is supplied with a standard jumper. For the device to operate correctly, it must be mounted with the sensor side down.



- This energy-saving digital thermo-valve is a programmable regulation device for various heaters, but mainly radiators.
- It can be used to regulate temperature in closed rooms, thus helping to lower heat energy consumption.
- Functions:
  - manual mode - measuring and checking a manually set temperature
  - automatic mode - control between two temperatures based on a set time program:
    - Comfort temperature (factory settings 21 °C/70 °F)
    - Energy-saving temperature (factory settings 16 °C/61 °F).
- Intervals of heating and energy-saving operation can be set using a freely adjustable time program.
  - 8 individually programmable switching times per day:
    - 4 heating intervals
    - 4 energy-saving intervals.
- The device features very quiet operation and long battery life (up 5 years).
- Quick and easy installation.

EAN code  
ATV-1:8595188160889

**Technical parameters**

**ATV-1**

Operating voltage:	3 V/DC (2 AA batteries 1.5 V/DC AA)
Temperature range:	8 .. 28 °C (46 .. 82 °F)
Colour:	white
Dimensions (L x W x H):	76.5 x 53.5 x 63 mm (3" x 2.1" x 2.4")
Design:	thermostatic direction valves, electronic

**Examples of daily heating program**

**LIVING ROOM**

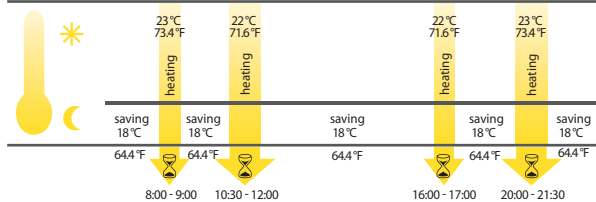

**BATHROOM**

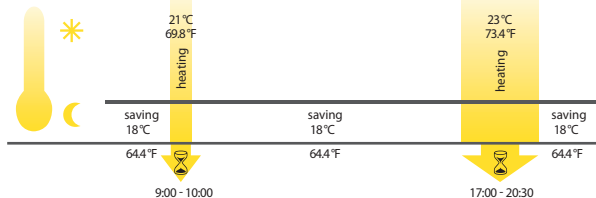

**Description of device**

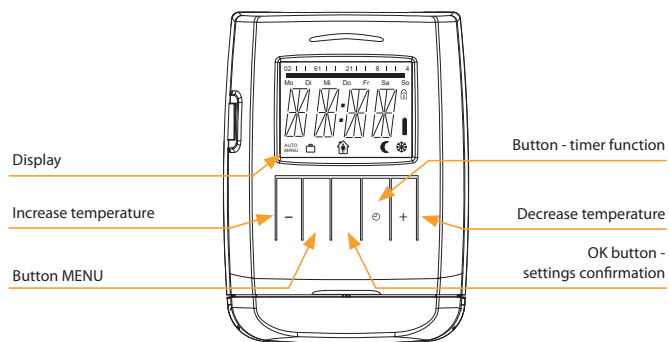

**Other functions**

1. Time function - the desired temperature can be set for a certain adjustable time interval.
2. Vacation function - while you're gone, you can set and maintain the desired temperature.
3. Open window function - when the temperature drops, the heating valve automatically closes in order to save energy.
4. Child safety block - blocking against undesired interference with the thermostat.
5. Freeze protection - if the temperature drops below 6 °C (43 °F), the valve opens until the temperature again exceeds 8 °C (46 °F). This keeps heaters from freezing.

**Adapters**

Type of valve	Type of adapter
Heimeier, Junkers Landys+Gyr, MNG, Honeywell, Braukmann thread size M 30x1.5	No adapter necessary + enclosed pin; only for RAV
Danfoss RAV (the valve plunger must be fitted with the enclosed pin)	
Danfoss RA	
Danfoss RAVL	



EAN code  
 TELVA-2 230 V, NO: 8595188181969  
 TELVA-2 230V, NC: 8595188181976  
 TELVA-2 24 V, NO: 8595188181983  
 TELVA-2 24 V, NC: 8595188181990

Technical parameters	TELVA-2 230V		TELVA-2 24V	
	NO	NC	NO	NC
Operating voltage:	230 V (50-60 Hz)		24 V (50-60 Hz)	
Switching current max:	300 mA		500 mA	
Operating current:	13 mA		100 mA	
Closing/opening time:	3-5 min		3-5 min	
Power input:	2.9 W		2.4 W	
Protection:	IP54		IP54	
Settings:	4 mm (0.16")		4 mm (0.16")	
Stopping force:	90-110 N		90-110 N	
Cable length:	800-1000 mm (31 - 39")		800-1000 mm (31 - 39")	
Connecting wire:	2 x 0.75 mm <sup>2</sup>		2 x 0.75 mm <sup>2</sup>	
Media temperature:	-5 .. 60 °C (23 .. 140 °F)		-5 .. 60 °C (23 .. 140 °F)	
Colour:	white RAL 9003		white RAL 9003	
Dimensions h/w/d:	63 x 42 x 45 mm (2.5 x 1.7 x 1.8")		63 x 42 x 45 mm (2.5 x 1.7 x 1.8")	
Connection size:	M30 x 1.5 mm (1.2" x 0.06")		M30 x 1.5 mm (1.2" x 0.06")	

- Thermodrive is intended for opening or closing valves in heating, cooling or air conditioning systems. It is also suitable for use in a floor heating or ceiling cooling manifolds.
- Available in NO (open without voltage), NC (closed without voltage) and for 230V and 24V.
- The internal principle of operation of the thermo drive mechanism = its movement so that the valve opens/closes is provided by an electric heating element with expansion material, which expands due to temperature changes in the supply voltage.
- The thermodrive is maintenance-free and works completely silently.
- The thermodrive is fitted with a metal nut M30 x 1.5, thanks to which it becomes a 100% fixed part of the valve with this corresponding thread size after installation.
- The stated nut size predetermines the use of a thermocouple with valves from manufacturers such as Herz, HoneyWell, Danfoss, Oventrop and others.

- Telva thermodrive:
  - is characterized by absolutely quiet and maintenance-free operation
  - is designed for installation - control of heating and cooling systems
  - method of mounting the actuator on the controlled valve using an M30 x 1.5 nut
  - any working position.
- Type of use:
  - Underfloor heating - the RFTC-50/G wireless controller measures the room temperature and, based on the set program, sends a command to the RFSA-66M switching element to open/close the TELVA thermo drive on the distributor.



EAN code			
TC-0:	8595188110075	TZ-0:	8595188140591
TC-3:	8595188110617	TZ-3:	8595188110600
TC-6:	8595188110082	TZ-6:	8595188110594
TC-12:	8595188110099	TZ-12:	8595188110587
Pt100-3:	8595188136136	Pt100-6:	8595188136143
Pt100-12:	8595188136150		

Technical parameters	TC	TZ	Pt100
Range:	-20..+80 °C (-4..176 °F)	-40..+125 °C (-40..257 °F)	-30..+200 °C (-22..392 °F)
Scanning element:	NTC 12K	NTC 12K	Pt100
Tolerance:	±(0.15°C + 0.002 t )	±(0.15°C + 0.002 t )	±(0.3°C + 0.005 t )
In air/in water:	(τ0.5) ≤ 18 s	(τ65) 62 s/8 s	(τ0.5) - /7 s
In air/in water:	(τ0.9) ≤ 48 s	(τ95) 216 s/23 s	(τ0.9) - /19 s
Cable material:	PVC unshielded, 2x 0.25 mm <sup>2</sup>	PVC unshielded, 2 x 0.34 mm <sup>2</sup>	shielded silicone 2 x 0.22 mm <sup>2</sup>
Terminal material:	polyamide	stainless steel	Copper
Protection degree:	IP67	IP67	IP67
Electrical strength:	2500 VAC	2500 VAC	2500 VAC
Insulation resistance:	> 200 MΩ at 500 VDC	> 200 MΩ at 500 VDC	> 200 MΩ at 500 VDC

Types of temperature sensors			
	TC-0	TZ-0	-
Length:	100 mm	110 mm	-
Weight:	5 g	4.5 g	-
	TC-3	TZ-3	Pt100-3
Length:	3 m	3 m	3 m
Weight:	70 g	106 g	68 g
	TC-6	TZ-6	Pt100-6
Length:	6 m	6 m	6 m
Weight:	130 g	216 g	149 g
	TC-12	TZ-12	Pt100-12
Length:	12 m	12 m	12 m
Weight:	250 g	418 g	249 g

τ65 (95): time, which sensor needs to heat up on 65 (95) % of ambient temperature of environment, in which is located.

- Thermister temperature sensors are made of Negative Temperature Coefficient (NTC) embedded in a PVC or metal sleeve with a thermally-conductive sealer.
- **Sensor TC**
  - lead-in cable to sensor TC is made of wire CYSY 2D x 0.5 mm/0.02".
- **Sensor TZ**
  - cable VO3SS-F 2D x 0.5 mm/0.02" with silicone insulation for use in high temperature applications
  - silicone insulation for use in high temperature applications.
- **Sensor Pt100**
  - shielded silicon 2x 0.22 mm<sup>2</sup> (AWG 21), shielding connected with a case.
- Temperature sensors can be connected directly to the terminal block.
- Cable lengths can not be changed, connected or modified.

Resistive values of sensors in dependance on temperature

Temperature (°C/°F)	Sensor NTC (kΩ)	Sensor Pt100 (Ω)
20 /68	14.7	107.8
30 /86	9.8	111.7
40 /104	6.6	115.5
50 /122	4.6	119.4
60 /140	3.2	123.2
70 /158	2.3	127.1

Tolerance of sensor NTC 12 kΩ is ± 5 % by 25 °C/77 °F.  
Long-term resistance stability by sensor Pt100 is 0.05 % (10 000 hours).

Diagramm of sensor warm up via air

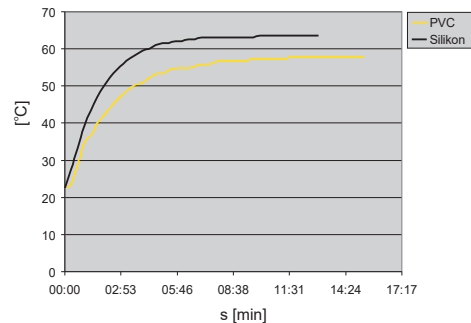

PVC - reaction to air temperature from 22.5 °C .. 58 °C (from 72.5 ..136.4 °F).

Silicone - reaction to air temperature from 22.5 °C .. 63.5 °C (from 72.5 .. 144.5 °F).



If you are interested in our products, visit one of our free professional trainings in the Czech Republic

All trainings at: [www.elkoep.com/trainings-and-exhibitions](http://www.elkoep.com/trainings-and-exhibitions)

Technical support

In case of technical questions, contact our technical support by phone or email:



**+420 770 177 028**  
**[balla@elkoep.com](mailto:balla@elkoep.com)**



**+420 800 100 671**  
**[support@elkoep.com](mailto:support@elkoep.com)**

Alternatively, you can contact us using the contact form on our website:  
[www.elkoep.com/tech-support](http://www.elkoep.com/tech-support)





Problematic choice of suitable relay contact for a particular load switched with a product is described below. Mostly we experience problems with incorrect choice of load (meaning incorrect relay for a particular load) which results in permanent switching of contact (sealing) or damage on relay contact – which then results in malfunction. What load can you use? Detailed types of load according to standard EN 60947 are described in charts below – categories of use.

Category of use	Typical use	EN
AC current, $\cos\phi = P/S$ (-)		
AC-1	Non-inductive or slightly inductive load, resistance furnace Includes all appliances supplied by AC current with power factor ( $\cos\phi$ ) $\geq 0.95$ Examples of usage: resistance furnace, industrial loads	60947-4
AC-2	Motors with slip-ring armature, switching off	60947
AC-3	Motors with short-circuit armature, motor switching when in operation This category applies to switching off motors with short-circuit armature while in operation. While switching, contactor switches current which is 5 up to 7 times rated current of motor.	60947-4
AC-4	Electro-motors with short-circuit armature: start up, braking by backset, changeover	60947
AC-5a	Switching of electrical gas-filled lights, fluorescent lights	60947-4
AC-5b	El. bulb switching Enables low contact loading due to resistance of cold fiber is many times smaller than the one of hot fiber.	60947-4
AC-6a	Switching of transformers	60947-4
AC-6b	Switching of capacitors	60947-4
AC-7a	Switching low inductive loads of home appliances and similar applications	60947
AC-7b	Load of motors for home appliances	60947
AC-8a	Switching of hermetically sealed motors of cooling compressors with manual reset switches against overload Hermetically sealed cooling compressors have to be placed in one box without external shaft or shaft padding and motor must operate with cooling liquid	60947
AC-8b	Switching of hermetically sealed motors of cooling compressors with manual reset switches against overload Hermetically sealed cooling compressors have to be placed in one box without external shaft or shaft padding and motor must operate with cooling liquid	60947
AC-12	Switching of semiconductor loads with separation transformers	60947-5
AC-13	Switching of semiconductor loads with separation transformers	60947-5-1
AC-14	Switching of low electro-magnetic loads (max.72 VA)	60947-5-1
AC-15	Management of alternating electro-magnetic loads This category applies to switching inductive loads with input for closed electro-magnetic circuit higher than 72 VA Use: switching coils of contactors	60947-5
AC-20	Connecting and disconnecting in unloaded states	60947-3
AC-21	Switching resistive loads, including low loading	60947-3
AC-22	Switching of mixed resistive and inductive loads, including low overloading	60947-3
AC-23	Switching of motor loads or other high inductive loads	60947-3
AC-53a	Switching of motors with short-circuit armature with semiconductor contactors	60947

Note: Category AC 15 replaces formerly used category AC 11

DC current,  $t = L/R$  (s)

DC-1	Non-inductive or low inductive load, resistive furnaces	60947-4
DC-3	Shunt motors: start-up, braking by backset, reversion, resistive braking	60947-4-1
DC-5	Series motor: start-up, braking by backset, reversion, resistive braking	60947-4-1
DC-6	Non-inductive or low inductive loads, resistive furnaces – el. bulbs	60947-4-1
DC-12	Management of resistive loads and fixed loads with insulation by opto-electric element	60947-5-1
DC-13	Switching of electromagnets	60947-5-1
DC-14	Switching of electromagnetic loads in circuits with limiting resistor	60947-5-1
DC-20a(b)	Switching and breaking without load(a: frequent switching ,b: occasional switching)	60947-3
DC-21a(b)	Switching ohmic loads including limiting overloading (a: frequent switching ,b: occasional switching)	60947-3
DC-22a(b)	Switching of compound ohmic and inductive loads including limited overloads (e.g. shunt motors) (a: frequent switching, b: random switching)	60947-3
DC-23	Switching of highly inductive loads (e.g. series motors)	60947-3

How can you distinguish for which load is our product (relay) designated?

Our company record this information on a products and also in our catalogue, instruction manual and other promotional and technical material (website etc.).



















It is important to realize that it is not always possible to point out load because of lack of information about the device (user cannot measure  $\cos\phi$ ) or it is not possible because of inconstancy of parameters of switched device. Manufacturer of relays records always guaranteed parameters in ideal conditions which are done by a norm (temperature, pressure, humidity, etc.) and reality can be in a lot of cases different. Category of use (classification) of a particular relay is done by material of output contacts.

Basic types of materials which are used for production of contacts for high-performance relay are:



















- AgCd – suitable for switching ohmic loads. Before of harmfulness of Cd, this type of contact is remitted.
- AgNi – designated for switching resistive loads, good quality switching and conducting (contact doesn't oxidate) small currents/voltages, it is not designated for surge currents and loads with inductive component.
- AgSn or AgSnO<sub>2</sub> – suitable for switching loads with inductive component, not suitable for switching small currents/voltages, it is more resistive to surge currents, suitable for DC voltage switching, less suitable for switching loads of ohmic type.
- Wf (wolfram)-special contact designated for switching surge currents with inductive component.
- with gold (AgNi/Au)- Used for "improving" contacts for low currents/ voltages , prevents oxidation.



## SOU-2

type of load	 cos φ ≥ 0.95								
	AC1	AC2	AC3	AC5a uncompensated	AC5a compensated	AC5b	AC6a	AC7b	AC12
Material of contact AgSnO <sub>2</sub> , 8A	250V/8A	250V/5A	250V/4A	x	x	250W	250V/4A	250V/1A	250V/1A
type of load									
	AC13	AC14	AC15	DC1	DC3	DC5	DC12	DC13	DC14
Material of contact AgSnO <sub>2</sub> , 8A	x	250V/4A	250V/3A	30V/8A	30V/3A	30V/2A	30V/8A	30V/2A	x

## HRH-9

type of load	 cos φ ≥ 0.95								
	AC1	AC2	AC3	AC5a uncompensated	AC5a compensated	AC5b	AC6a	AC7b	AC12
Material of contact AgSnO <sub>2</sub> , 10A	250V/10A	250V/5A	250V/4A	x	x	250W	250V/4A	250V/1A	250V/1A
type of load									
	AC13	AC14	AC15	DC1	DC3	DC5	DC12	DC13	DC14
Material of contact AgSnO <sub>2</sub> , 10A	x	250V/4A	250V/3A	24V/10A	24V/3A	24V/2A	24V/10A	24V/2A	x

## VS120; VS220; VSM220

type of load	AC-1, AC-7a, AC-21	AC-2	AC-3, AC-3e, AC-7b, AC23	AC-5a (230V)	AC-5b (230V)	AC-6a (230V)	AC-15 (230V)	DC-1 (24V, 48V)	DC-3 (24V, 48V)	DC-5 (24V, 48V)	DC-13 (24V, 48V)	LED	AC-6b, AC-7c (230V)
rated current	20A	12A	NO9A NC6A	8,8A	8,8A	4A	6A	20A, 15A	10A, 5A	10A, 4A	6A	2,4A per contact	switching capacity 30 uF

## VS420

type of load	AC-1, AC-7a, AC-21	AC-2	AC-3, AC-3e, AC-7b, AC23	AC-5a (230V)	AC-5b (230V)	AC-6a (230V)	AC-15 (230V)	DC-1 (24V, 48V)	DC-3 (24V, 48V)	DC-5 (24V, 48V)	DC-13 (24V, 48V)	LED	AC-6b, AC-7c (230V)
rated current	20A	10A	5A	8,8A	8,8A	4A	6A	20A, 12A	10A, 5A	10A, 4A	6A	2,4A per contact	switching capacity 30 uF

## VS425; VSM425

type of load	AC-1, AC-7a, AC-21	AC-2	AC-3, AC-3e, AC-7b, AC23	AC-5a (230V)	AC-5b (230V)	AC-6a (230V)	AC-15 (230V)	DC-1 (24V, 48V)	DC-3 (24V, 48V)	DC-5 (24V, 48V)	DC-13 (24V, 48V)	LED	AC-6b, AC-7c (230V)
rated current	25A	14A	8,5A	11,2A	8,8A	2,8A	6A	25A, 20A	15A, 8A	15A, 5A	6A	3,8A per contact	switching capacity 36 uF

## VS440

type of load	AC-1, AC-7a, AC-21	AC-2	AC-3, AC-3e, AC-7b, AC23	AC-5a (230V)	AC-5b (230V)	AC-6a (230V)	AC-15 (230V)	DC-1 (24V, 48V)	DC-3 (24V, 48V)	DC-5 (24V, 48V)	DC-13 (24V, 48V)	LED	AC-6b, AC-7c (230V)
rated current	40A	25A	22A	20A	17,6A	10,8A	6A	40A, 25A	22A, 10A	20A, 8A	6A, 4A	11A per contact	switching capacity 220 uF

## VS463

type of load	AC-1, AC-7a, AC-21	AC-2	AC-3, AC-3e, AC-7b, AC23	AC-5a (230V)	AC-5b (230V)	AC-6a (230V)	AC-15 (230V)	DC-1 (24V, 48V)	DC-3 (24V, 48V)	DC-5 (24V, 48V)	DC-13 (24V, 48V)	LED	AC-6b, AC-7c (230V)
rated current	63A	32A	30A	32A	22A	17,2A	6A	63A, 26A	25A, 11A	25A, 10A	6A, 4A	18A per contact	switching capacity 330 uF

Packing of 1-MODULE relay - 1 pc



Packing of 1-MODULE relay - 10 pcs



Packing of 1-MODULE relay with accessories



Packing of 2-MODULE relay - 1 pc



Packing of 3-MODULE relay - 1 pc



1-MODULE

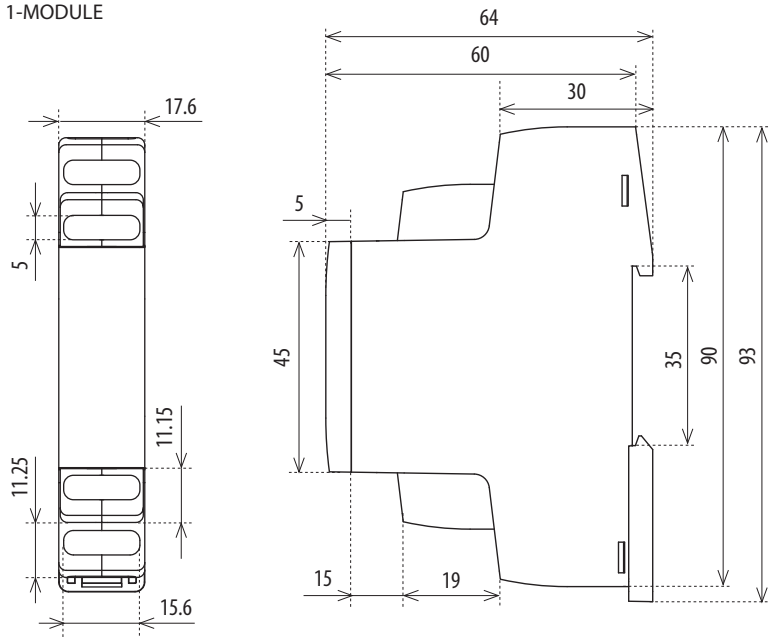

Front panels for 1-MODULE, examples of use:

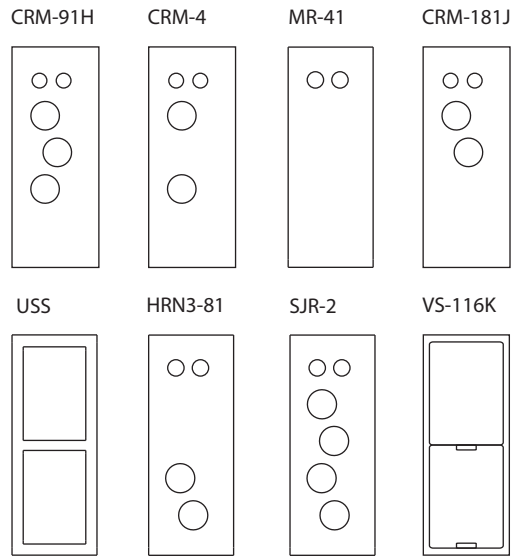

3-MODULE

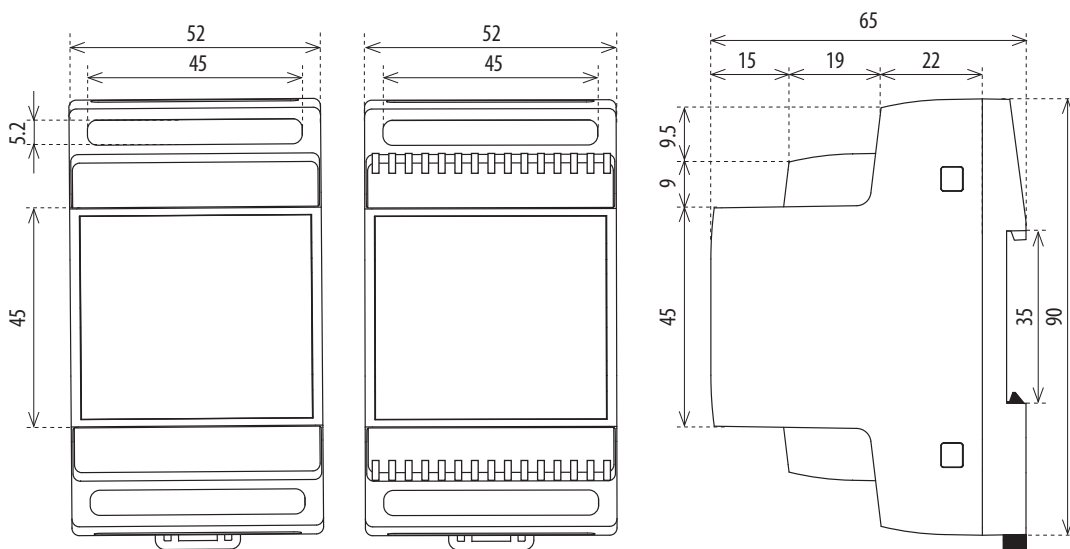

Front panels for 3-MODULE, examples of use:

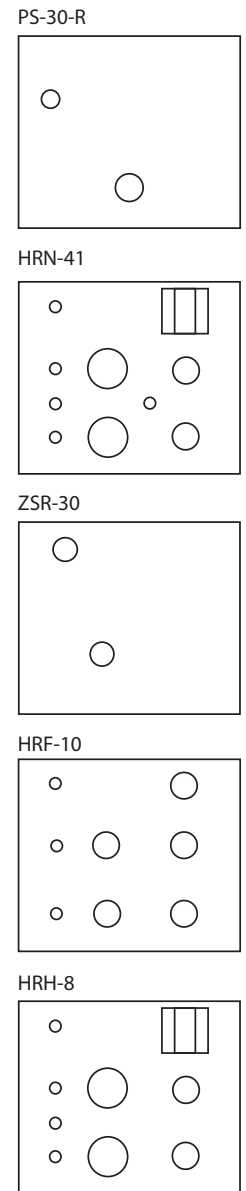

2-MODULE

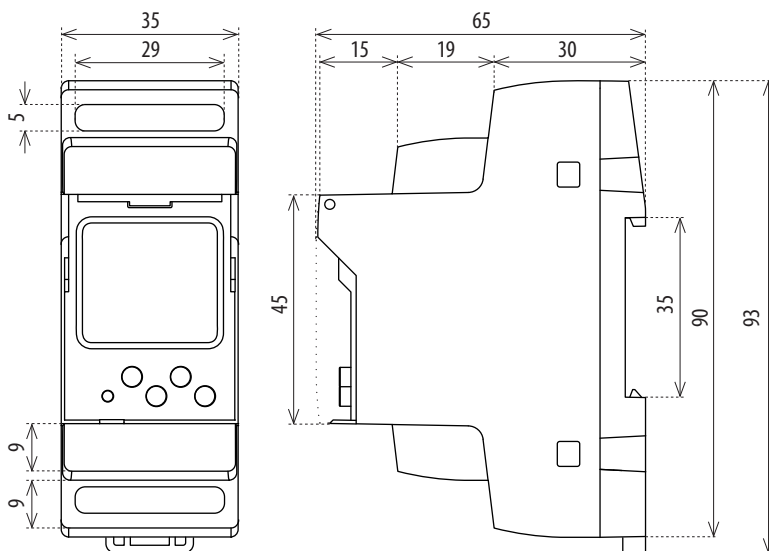

6-MODULE

Front panels for 6-MODULE, examples of use:

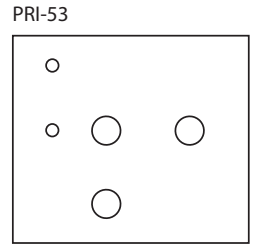
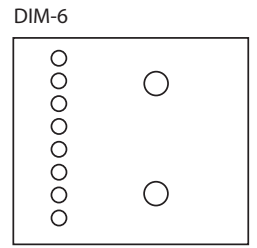
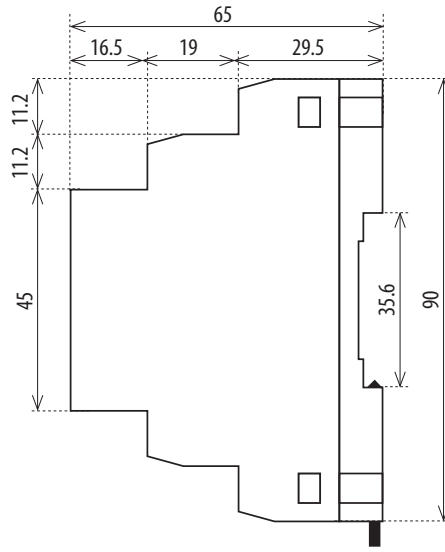
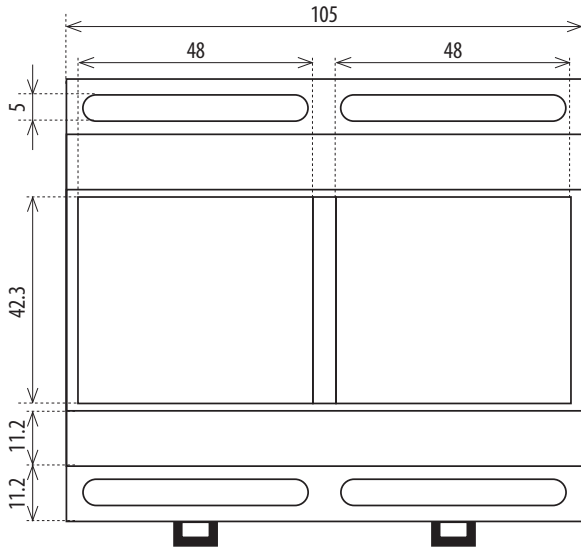

HRN-100

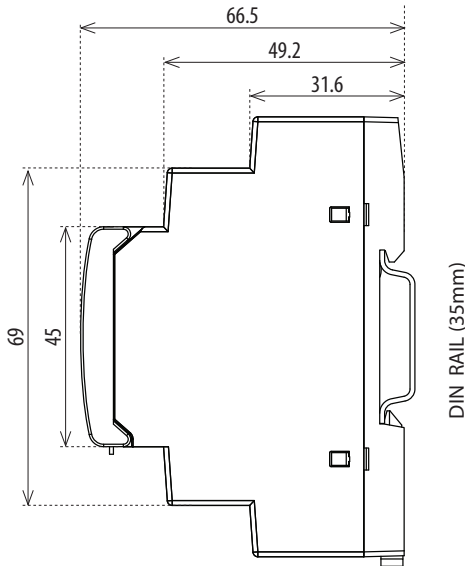
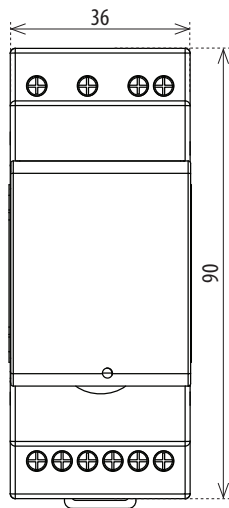

SMR-T, SMR-H, SMR-K

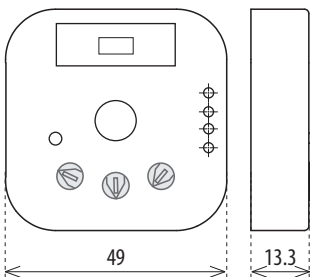

SMR-S

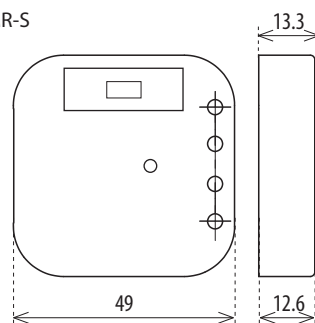

SMR-B

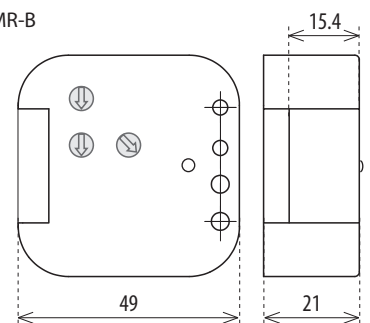

VS116/B

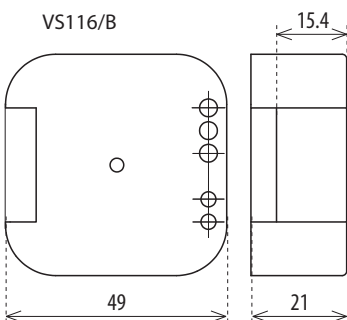

SMR-M

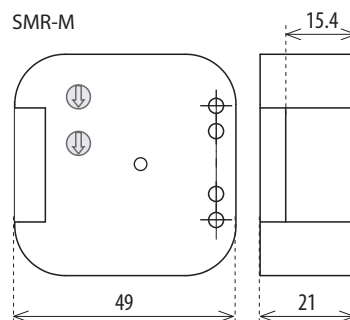

PSB-10

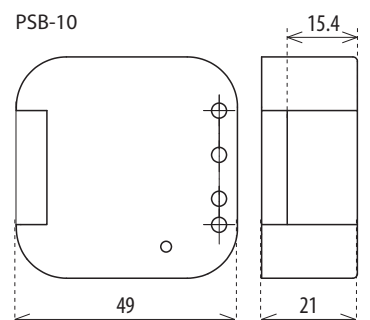



SOU-3

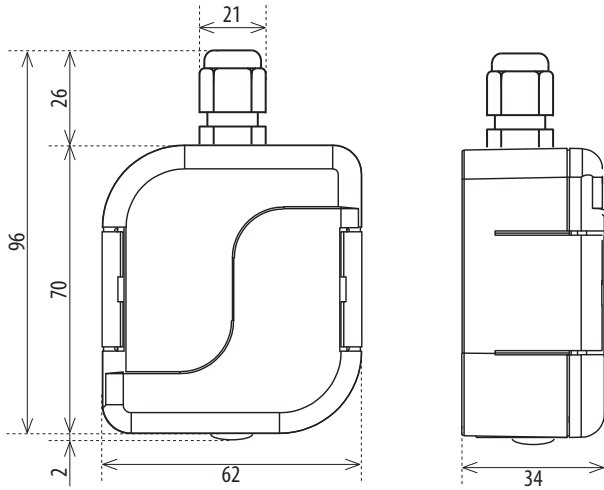

RHV-1, TEV-4

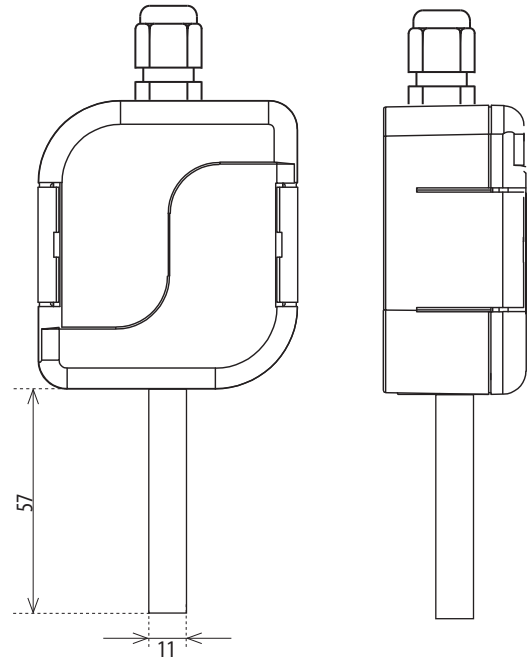

Temperature sensors

TC

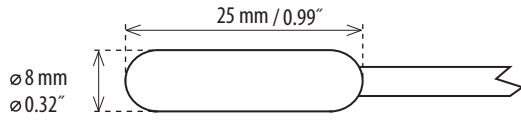

TZ

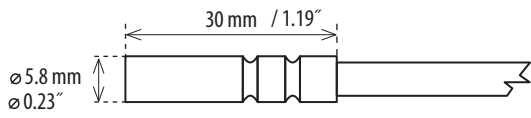

Pt100

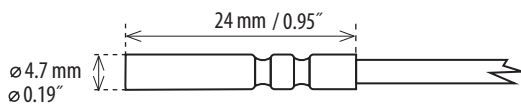

Photosensor SKS-100 / SKS-200

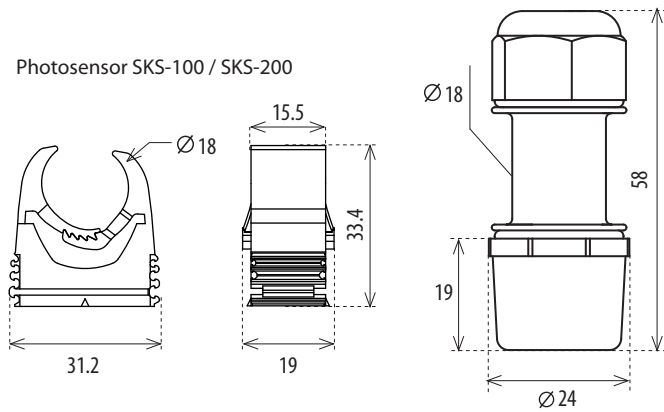

External potentiometer for CRM-2HE, CRM-91HE

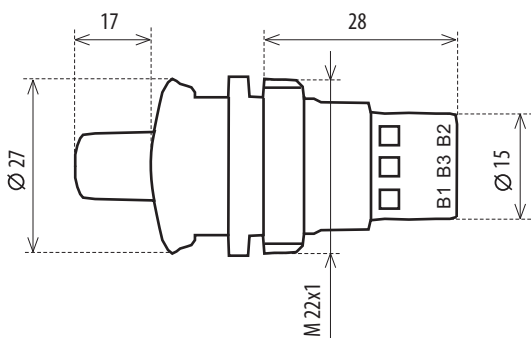

USS

Unit: 00

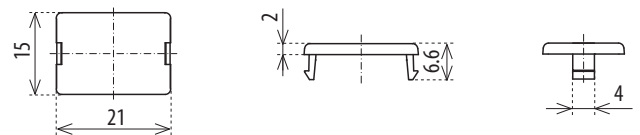

Unit: 01

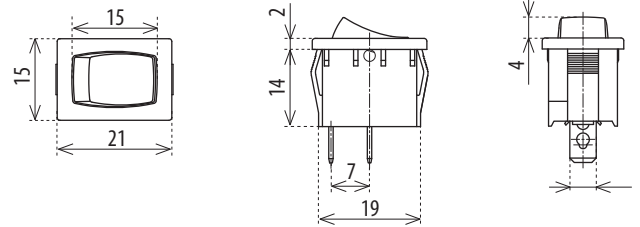

Unit: 02, 06, 07, 08, 09

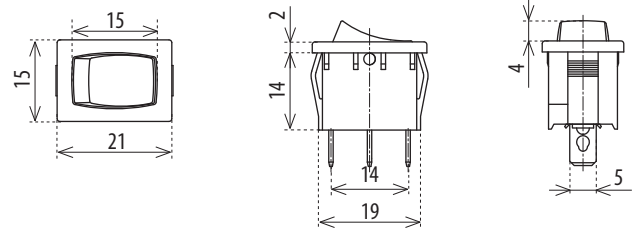

Unit: 03, 04, 05

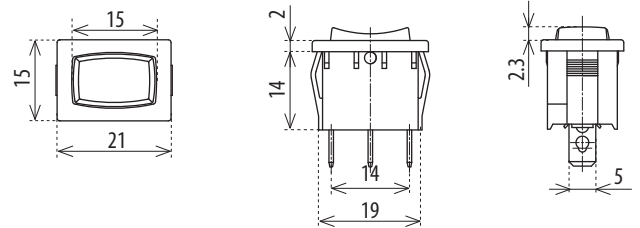

Unit: 10, 11, 12, 13, 14, 15

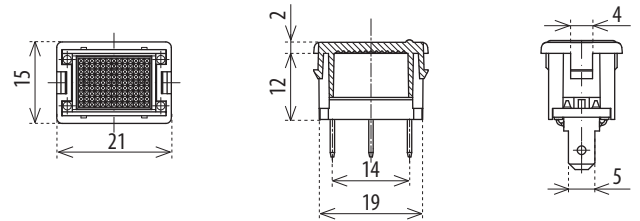

HRH-6

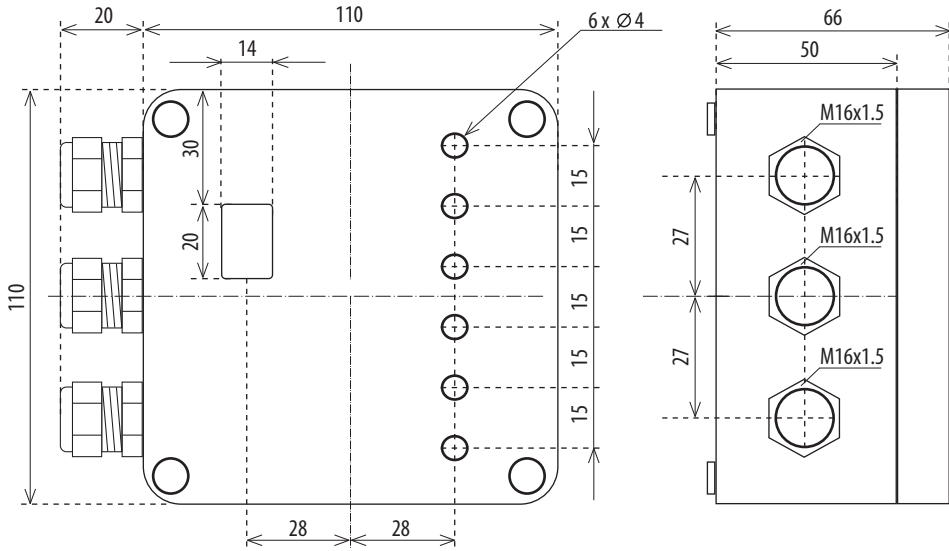

TEV-1, TEV-2

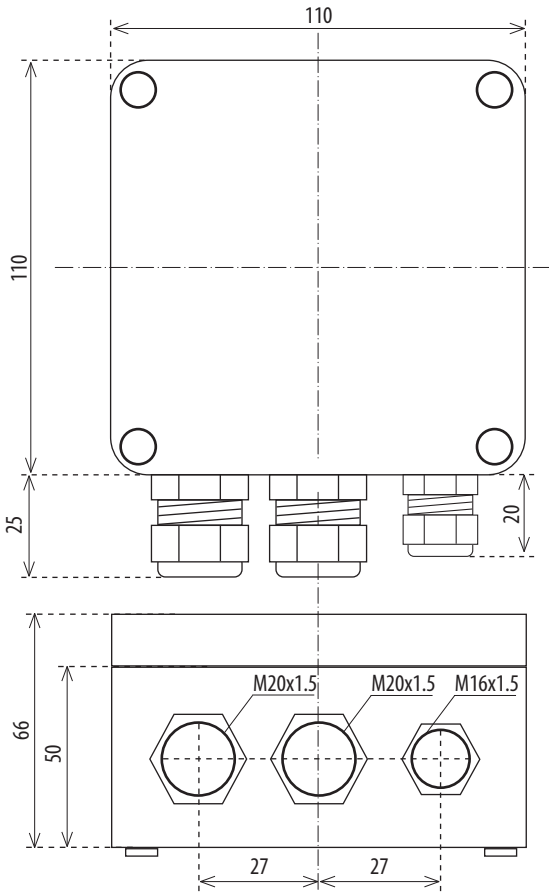

TEV-3

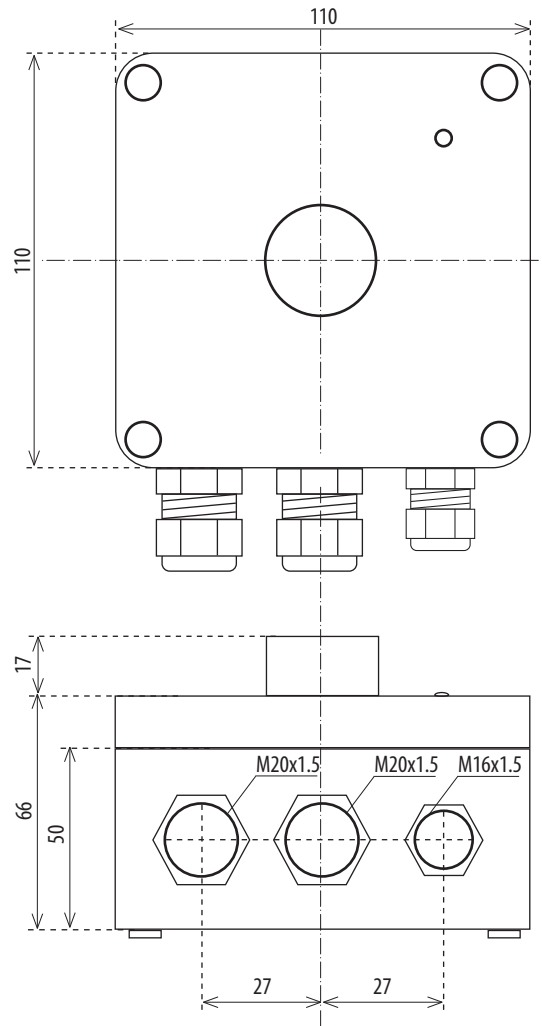

Level sensor

SHR-1

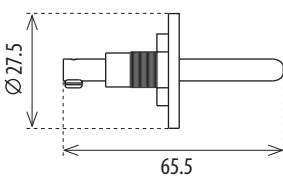

SHR-2

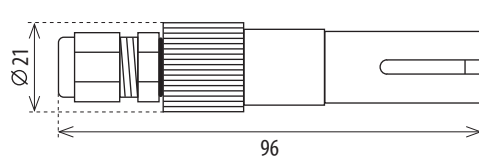

SHR-3

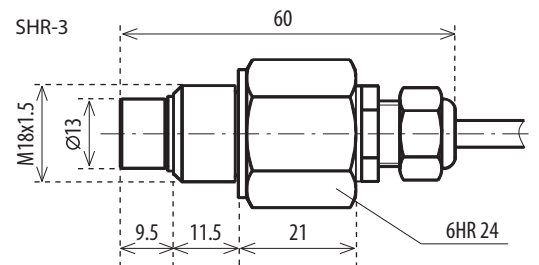

HRH-7

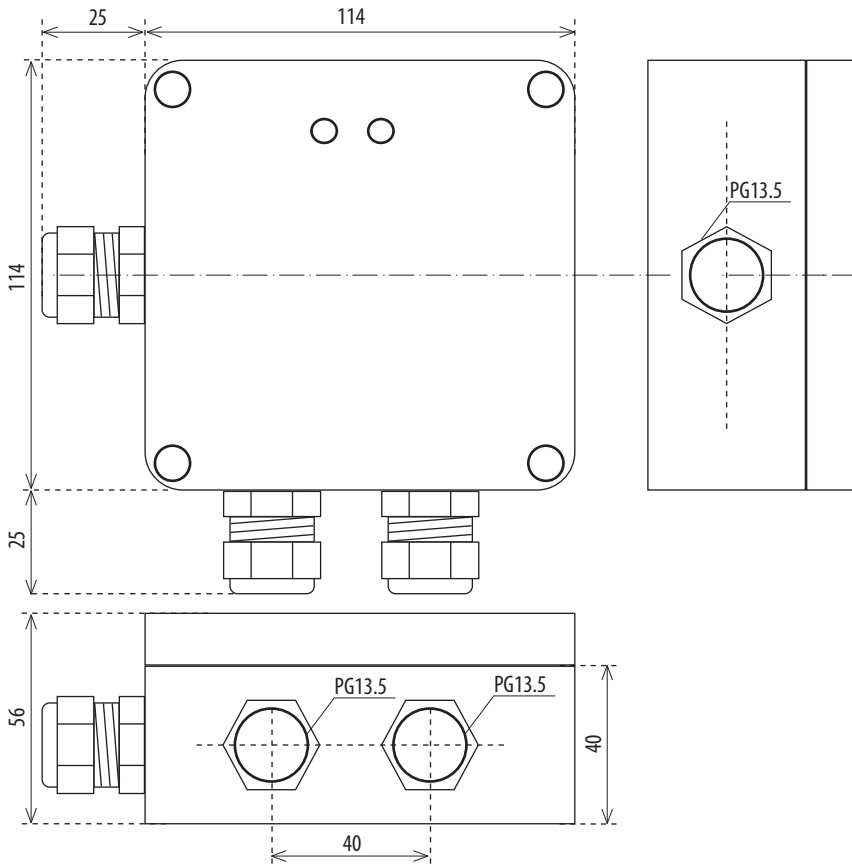

ATV-1

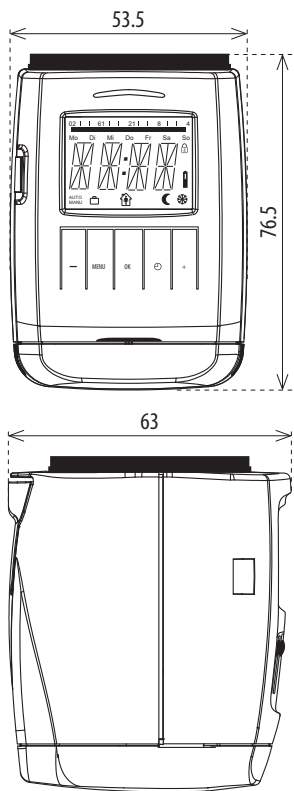

PMR3-70

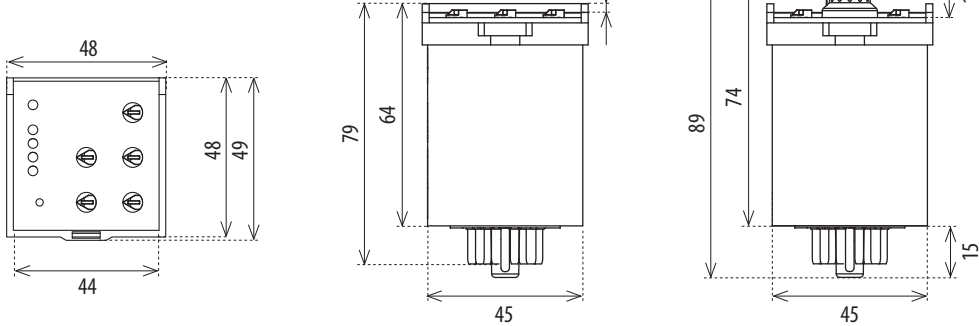

front panels PLUG-IN, examples of use:

PTRx-216T

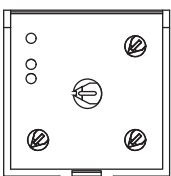

PTRx-216K

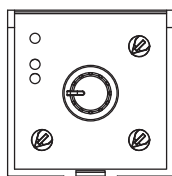

PMR1-3x

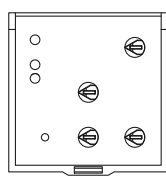

Comb busbar CB-17-8

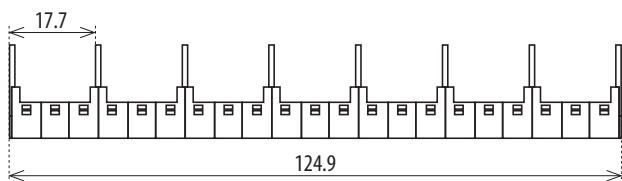

CRM-100

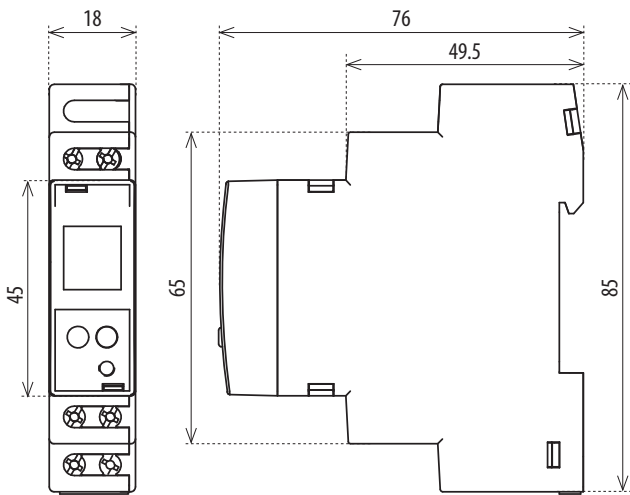

BR-216-10  
BR-216-11  
BR-216-20

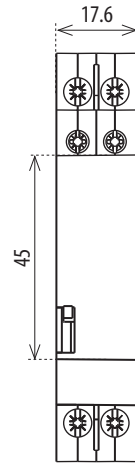

BR-220-20  
BR-232-20

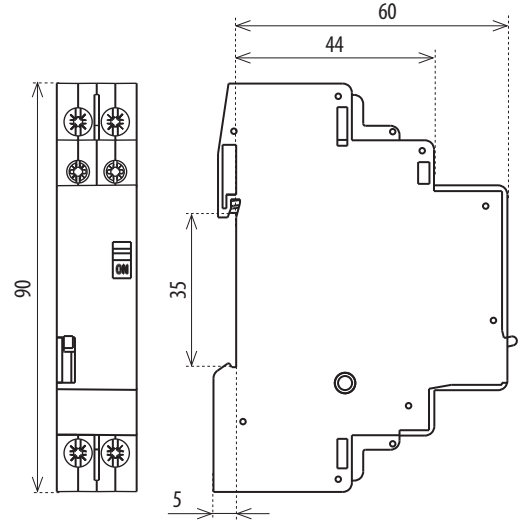

PS1M-15/12V  
PS1M-15/24V

PS2M-24/12V  
PS2M-30/24V

PS3M-54/12V  
PS3M-60/24V

PS4M-85/12V  
PS4M-92/24V

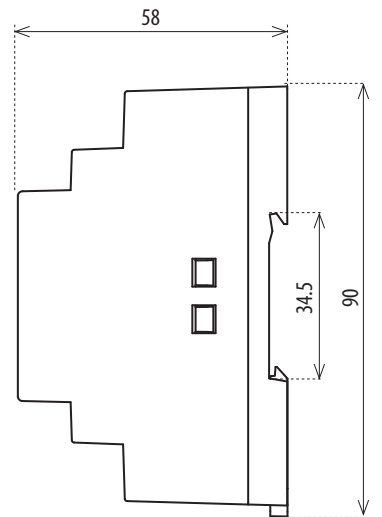
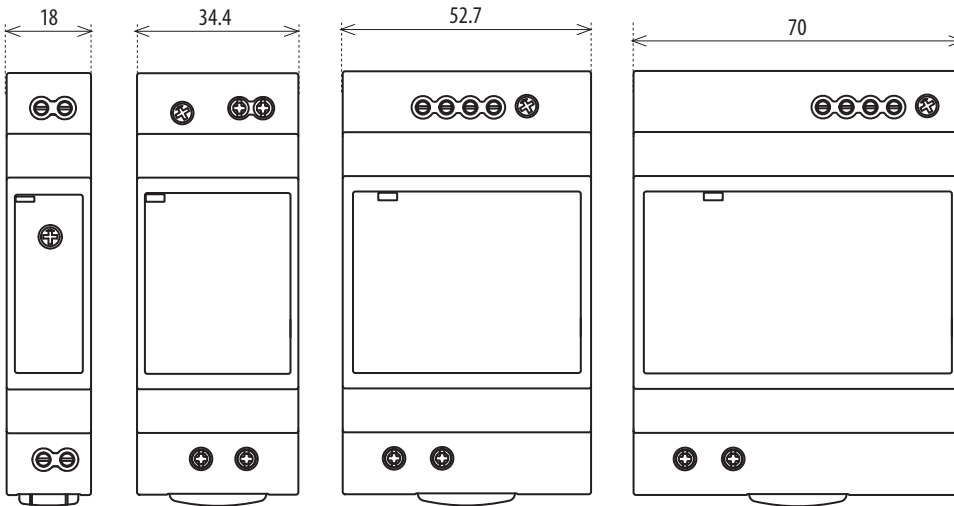

VS420

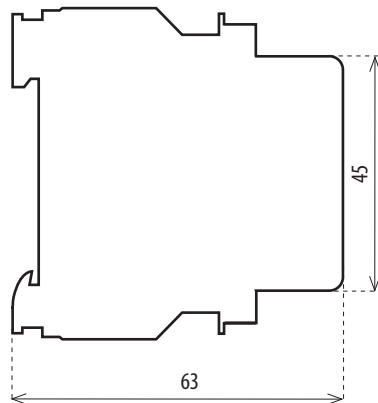
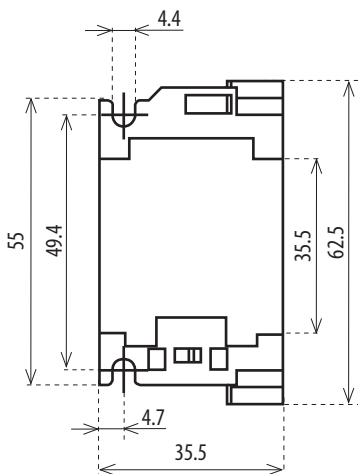

VS120  
VS220  
VSM220

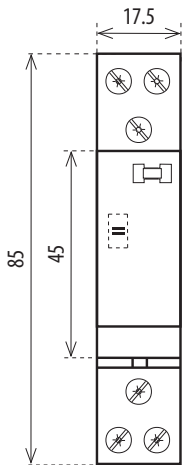

VS425  
VSM425

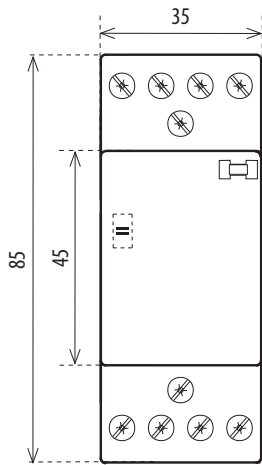

VS440  
VS463

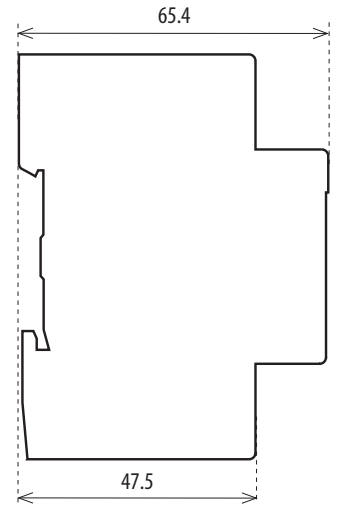
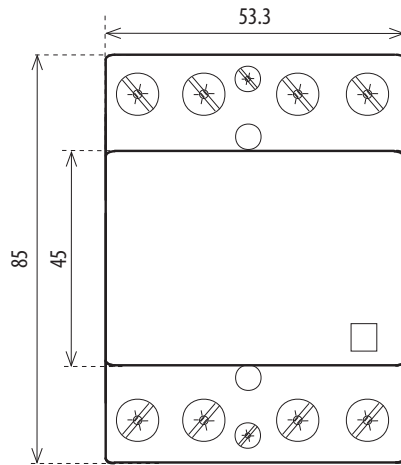

ATS-1DR

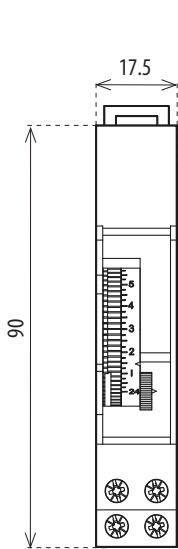

ATS-2DR

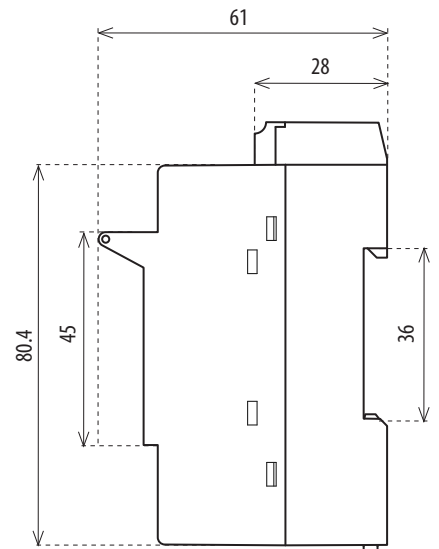
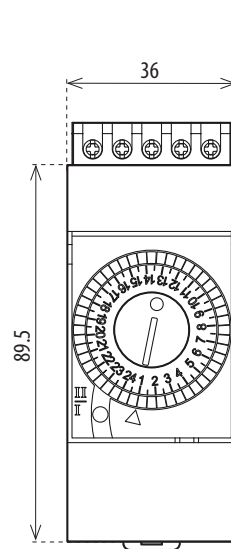
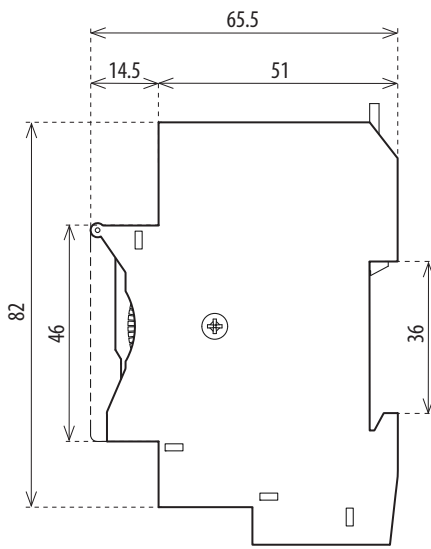

ATS-2WR, ATS-2D

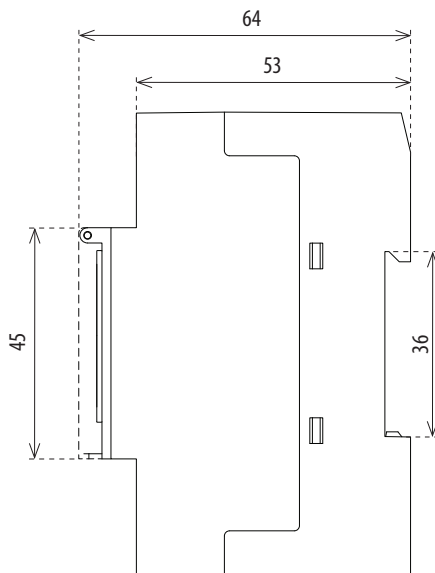
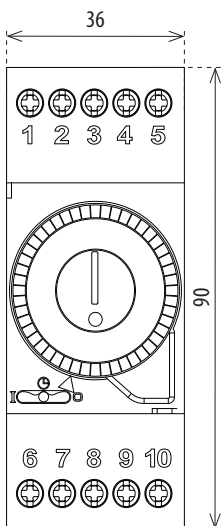

**Multifunction time relay CRM-91H, CRM-93H, CRM-91-SL, CRM-93H-SL**

- for electric appliances, where is necessary to change the exact timing - controlling of the illumination, heating, motors, machines, ventilators, contactors

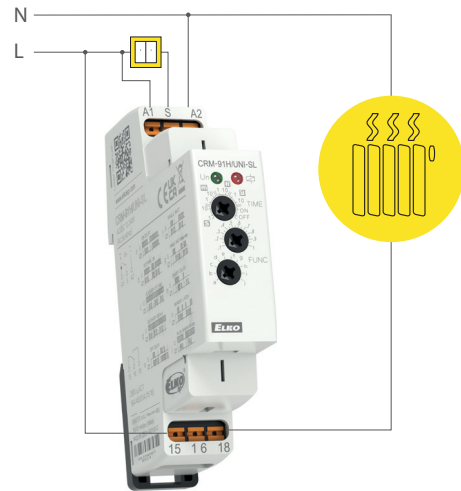

**Multifunction time relay with external potentiometer CRM-91HE**

- time adjusting via external operating unit, operating on panel, switchboard doors



**Doublestage delay unit SJR-2**

- for sequential load switching, electric furnaces, heaters

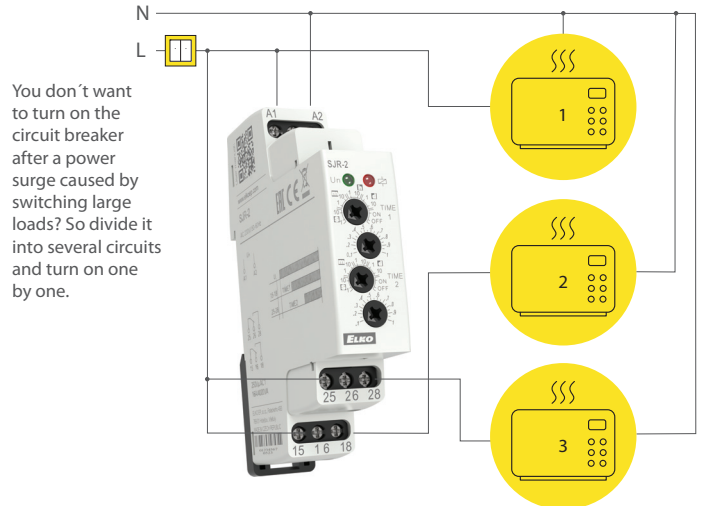

**Multifunction time relay CRM-161**

- for electronic appliances, light control, heating, motors, fans

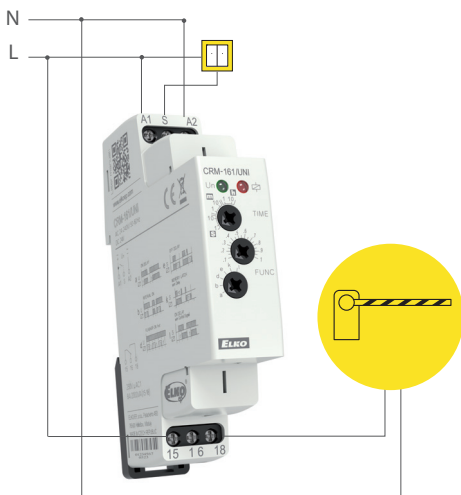

**Staircase switch CRM-4**

- staircase automatic systems, ventilators switching, for multiplace operating illumination on the staircases and halls

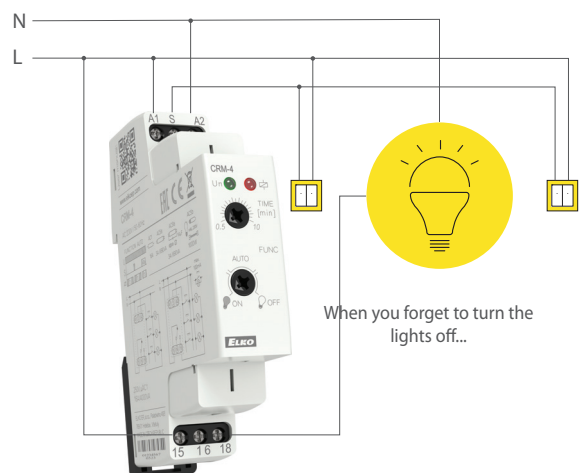



**Time relay PLUG-IN type PTRM-216TP**

- serves to control light signalization, heating, motor and fan control etc.



**Delay OFF without supply voltage CRM-82TO**

- delayed back-up switch off at current failure (emergency illumination, emergency respirator)

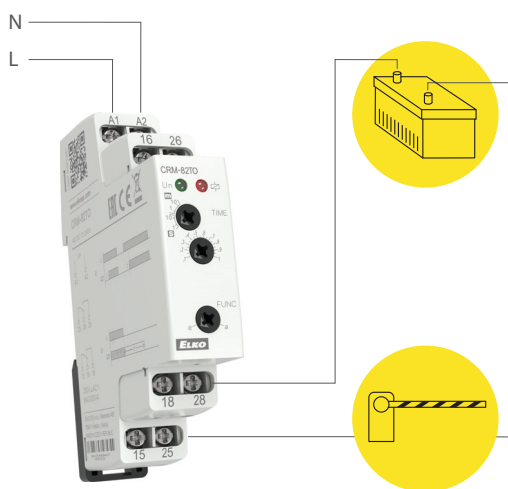

**Asymmetric flasher CRM-2H**

- regular rooms ventilation, cyclic humidity exhaustion, illumination controlling, circulation pump, flash, warning appliances, regular pump down, regular irrigation via electromagnetic valve

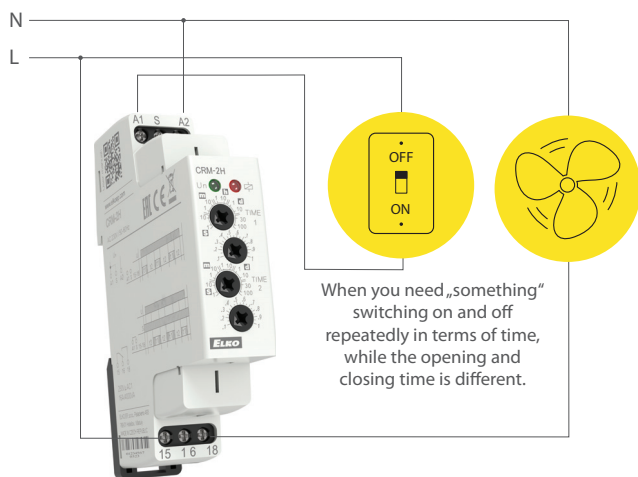

**Singlefunction time relay CRM-181J**

- time switch, using for run down the pump after switch off the heating, switching of ventilators

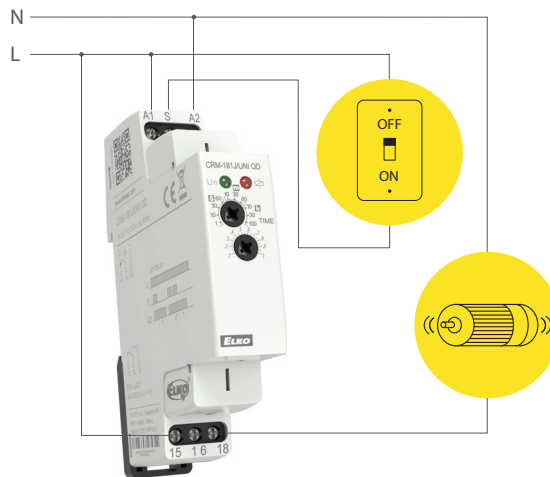

**Intelligent staircase automat with possible signalling before switch off CRM-46**

- staircase illumination operation  
 - on-coming switch off signalling (flash = comfort + safety together)  
 - prodloužení zpoždění počtem stisků tlačítka

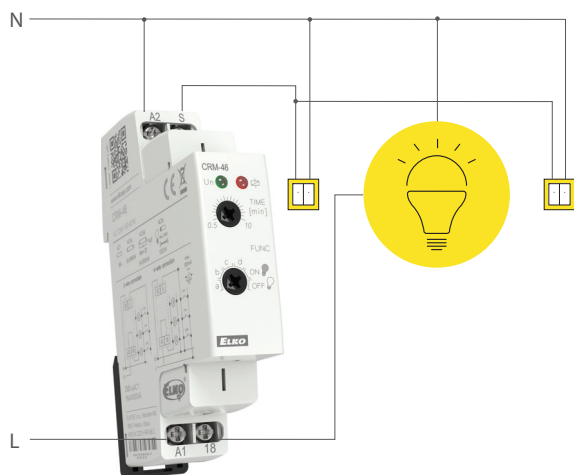

**Room energy saving relay CRM-101**

- replacement of the card switch (energy saving in the absence of guests)  
 - the relay controls e.g. the hotel room contactor by means of a magnetic door contact and a motion detector

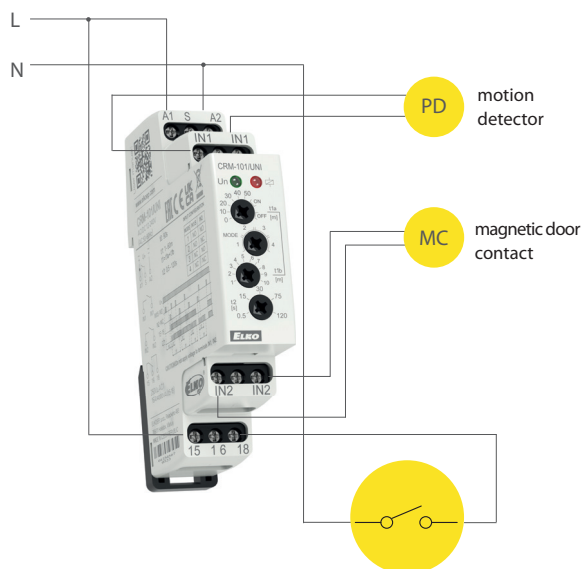

Digital time switch SHT-13, SHT-13/2

- for controlling of all appliances that depend on real time, appliances could be controlled in regular cycles, or according to adjusted program (blocking of main door out of working hours or night)
- in combination with other devices, controlling could be combined (rooms ventilation, irrigation controlling, bell at school or in church...)

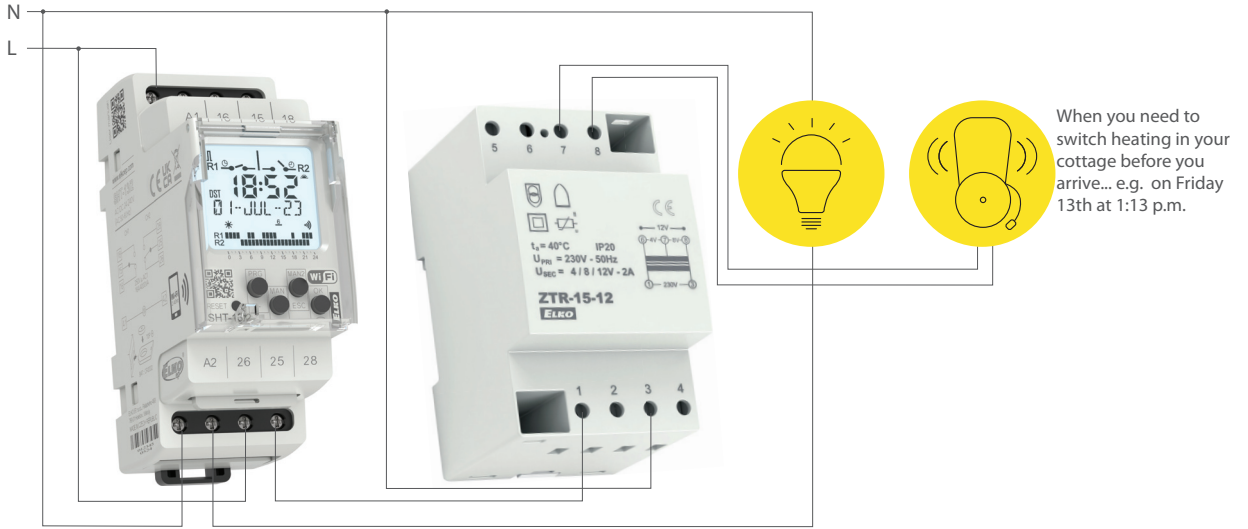

Programmable digital relay PDR-2

- illumination, ventilators, contactors controlling, controlling of interlocking plans, system of time abate and blocking (billiards, pin-balls....), away control via external buttons

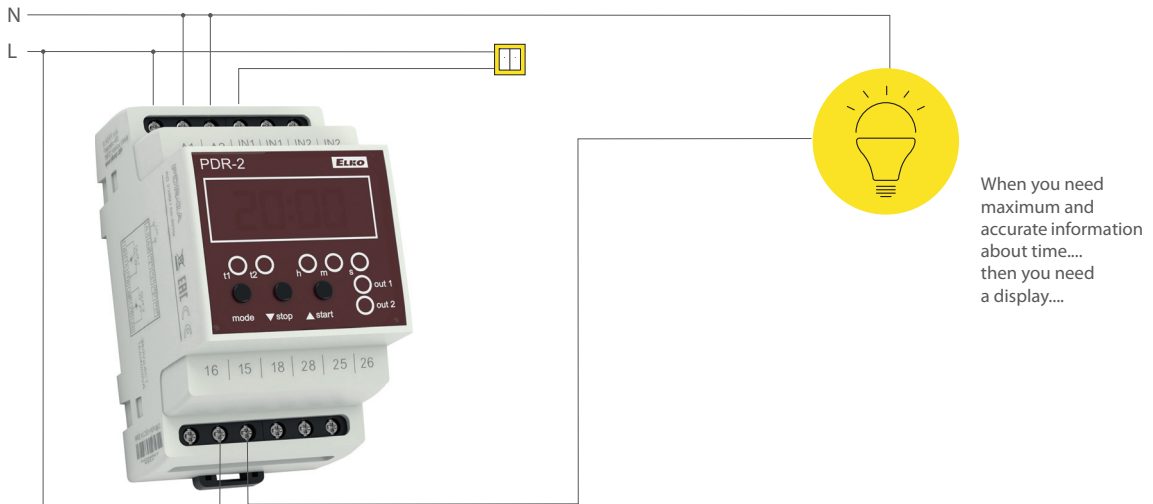

Twilight switch SOU-1

- outdoor illumination switching (garden illumination), flash, shop-window, hall and office illumination (switch off in desired light level, controlling of intensity)

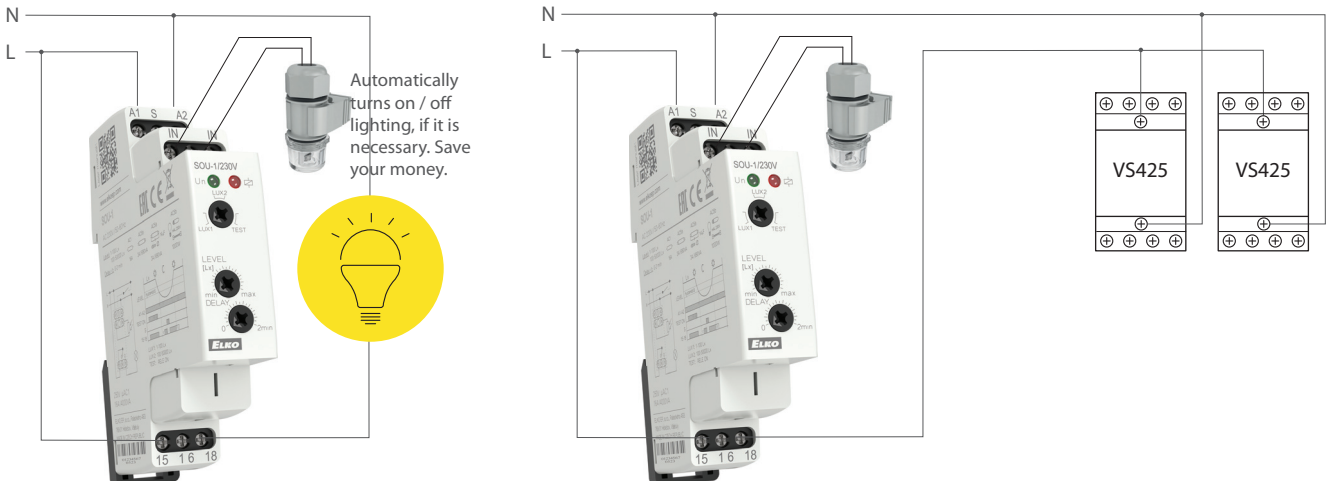

**Delay on star/delta CRM-2T**

- motor starting more than 3 kW, electronic switchover from mode start to mode operation with device CRM-2T, what assures exact timing

**Mini contactor VS425**

- switching of the higher loads, especially in other categories than AC1

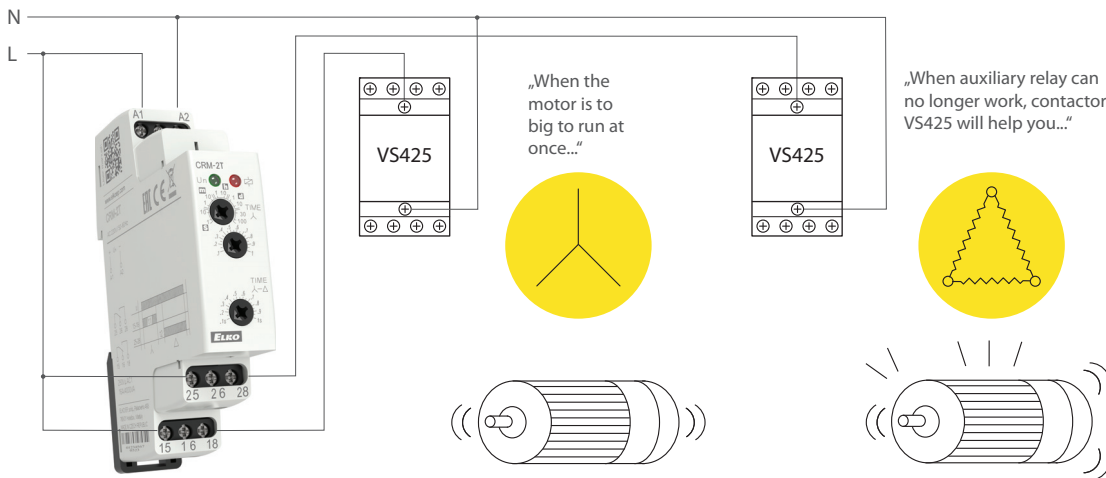

**Modular contactor VS120, VS220, VS420, VS425**

- to switch circuits for supply and control of heating, lights, air-conditioning and other el. devices.  
Switches loads AC-1, AC-3, AC-7a, AC-7b, AC-15.

**Modular contactors VS440, VS463**

- to switch supply and control circuits for heating, air-conditioning and other el. devices, switching 3-phase motors  
Switches loads A-1, AC-3, AC-7a, AC-7b, and AC-15

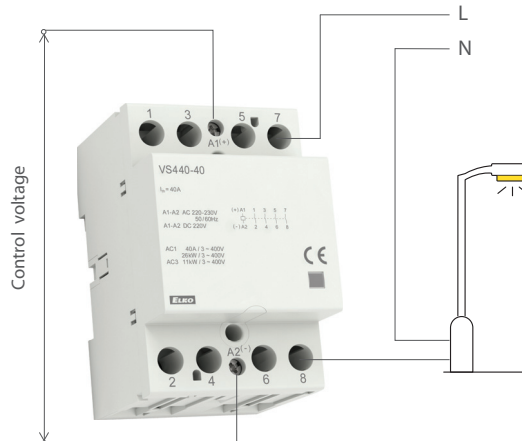
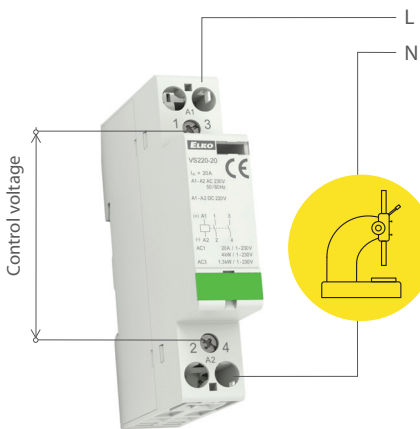

**Digital time switch SHT-1, SHT-1/2**

- for controlling of all appliances that depend on real time, in daily or weekly mode

**Staircase automat with dimming DIM-2**

- step by step (fluent) dim up, adjusted time is ON and fluent dim down (e.g. possible to adjust permanent shine to min. brightness everlasting light)  
- block of flats (entry, halls, staircases), garden lighting

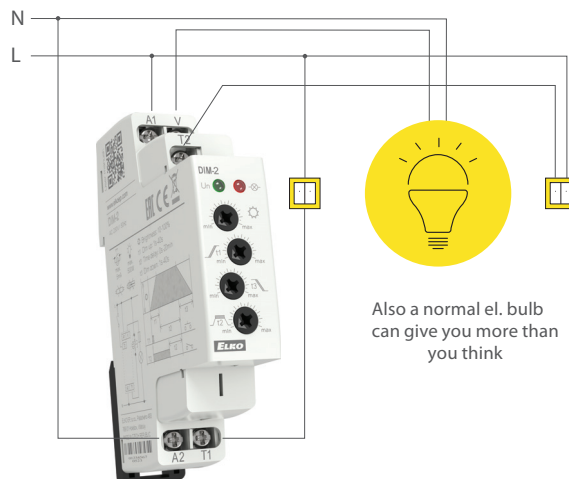

Also a normal el. bulb can give you more than you think

**Monitoring voltage relay HRN-31 (HRN-31/2)**

- monitoring of mains voltage for appliances inclinable to supply tolerance

**Monitoring voltage relay HRN-31 (HRN-31/2)**

- protection of appliances against under-/overvoltage

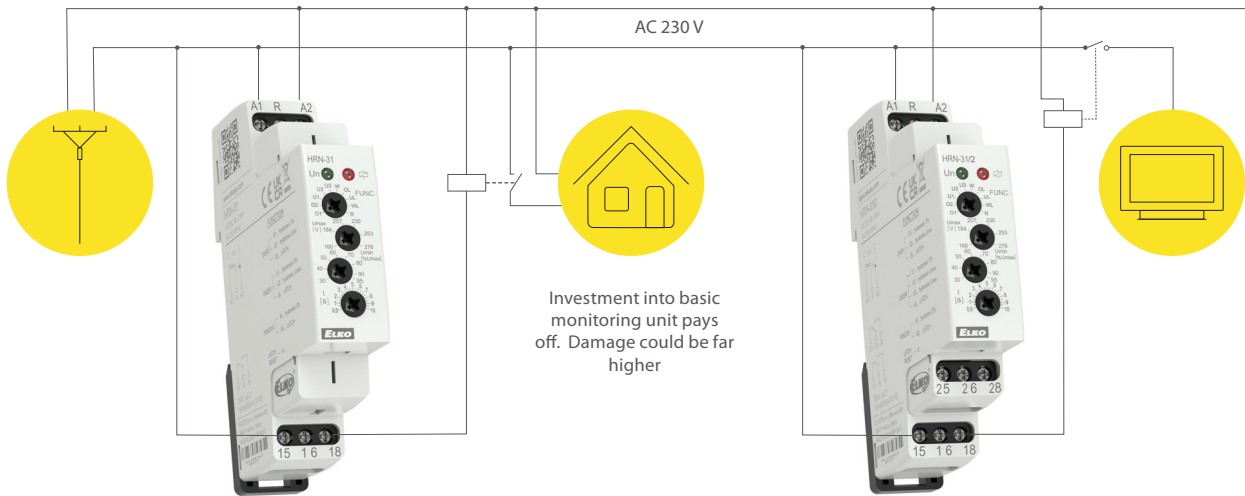

**Switching power supply PS-30-R**

- power supply of any devices and appliances via safe voltage with full galvanically separated from mains  
 - power supply of driving systems, interlocking plants and use in measurement and control

**Controlling and signalling units USS**

- compact dimensions, elegant design, wide range of use, configuration for request  
 - switching and signalling in switchboard, controlling centre, automation...

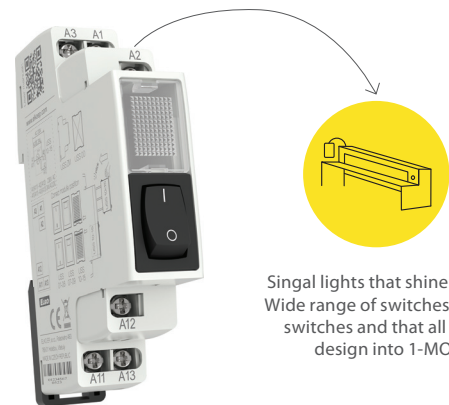
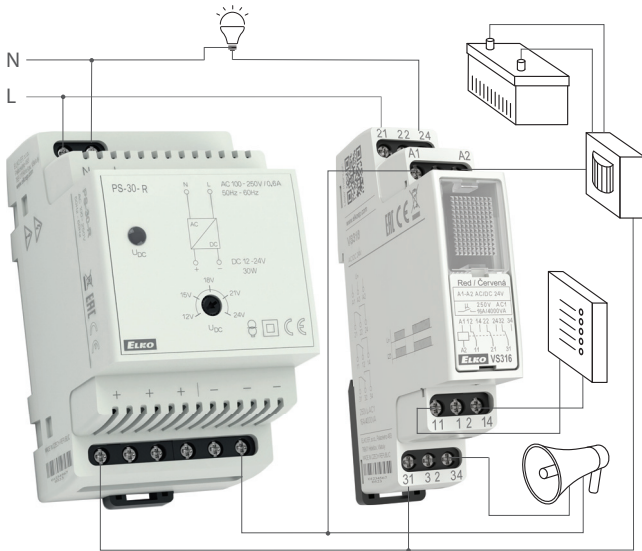

Singal lights that shine and flash:  
 Wide range of switches, alternating switches and that all in double design into 1-MODULE

**Monitoring voltage relay HRN-32/2**

- start of back-up supply in case of failure

**Monitoring voltage relay HRN-36**

- load disconnected when voltage declines or battery is discharged

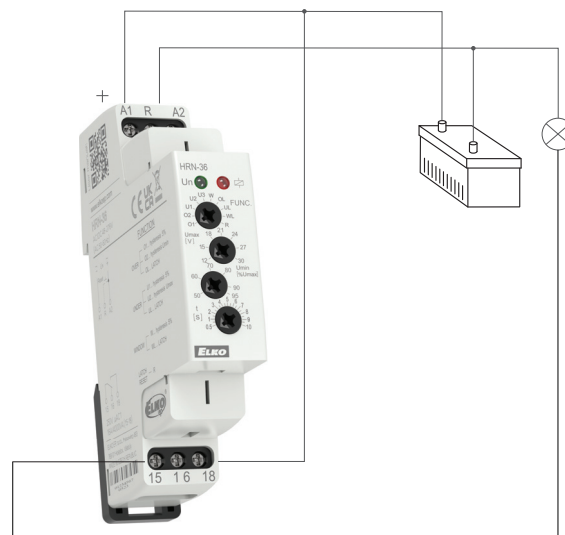
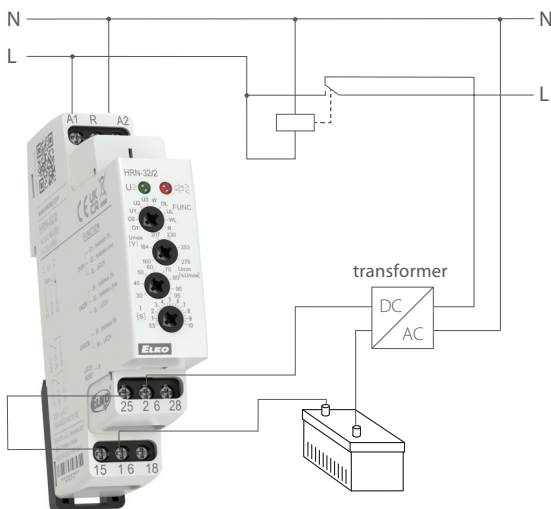

**Memory relay MR-41, MR-42**

- because of 2-wire parallel buttons connection save money, place and time during the installation
- light switching, hall, staircase, big rooms, controlling systems, automation

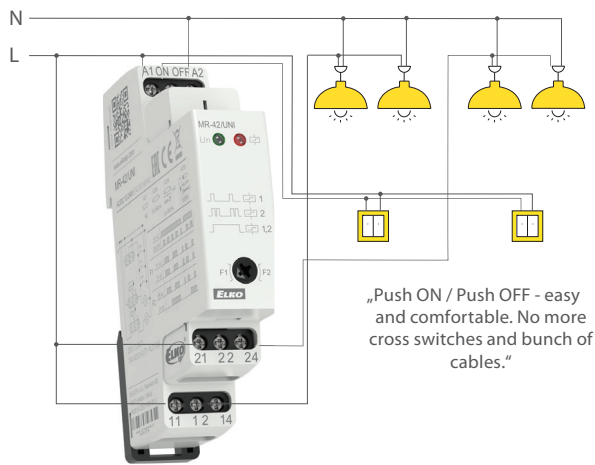

**Power relays VS**

- switching of higher load than is capacity of switched unit = repeater
- assistant light controlling, signalling, boilers, ...

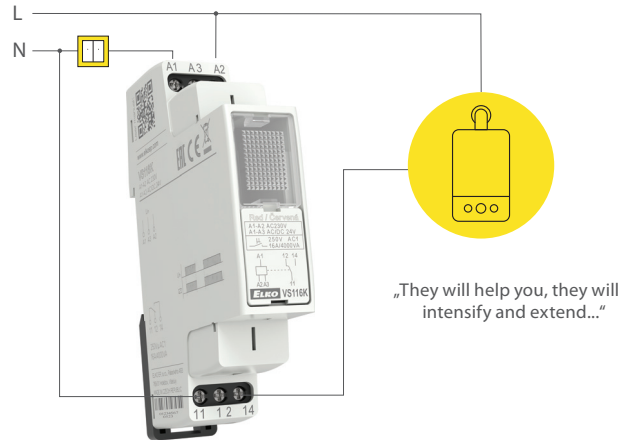

**Monitoring current relay PRI-51, PRI-32**

- current-limiting relay (on one branch two appliances, which never work together), controlling systems, motors, heating, current indication, controlling of 1-phase motor run down, during the installation of main housing switchboard could be controlled via eye, if the cooker is not switched
- in connection with current transformers, it is possible to extend current ranges up to 600A, which makes more things possible

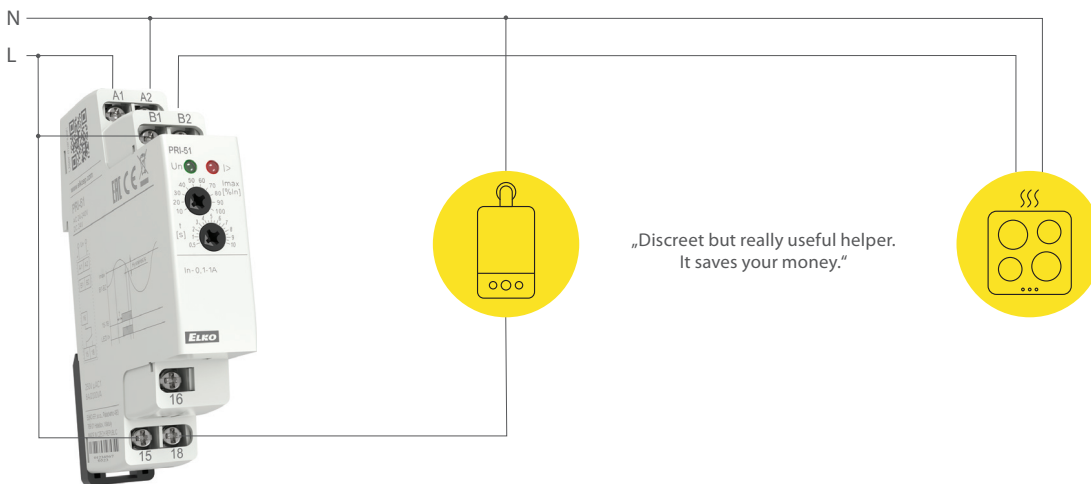

**Relay monitoring power factor COS-2**

- monitors power-factor in 3-phase mains / unloading of motors, pumps, lift systems

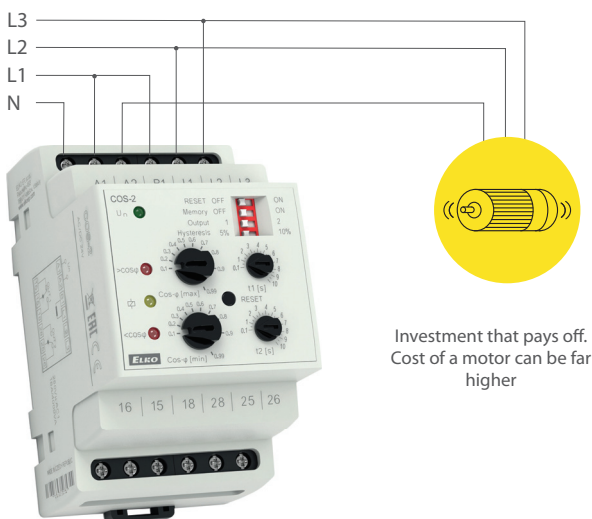

**Monitoring voltage relay HRN-43**

- regulation of voltage from generator, water el. plants, 3-phase control in the main
- monitors and protects main's quality

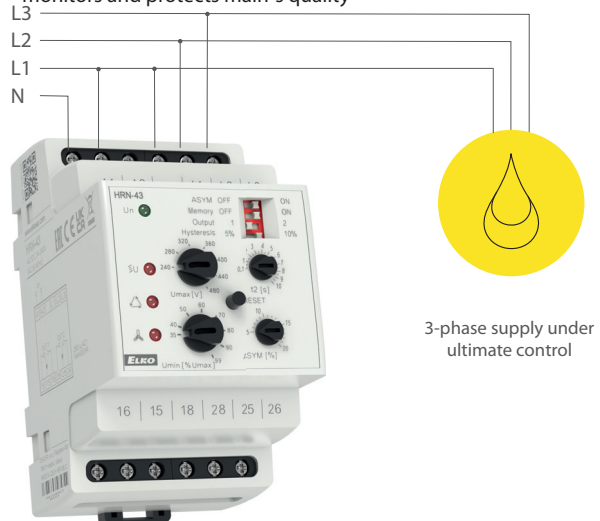



**Level switch HRH-8**

- monitoring level in wells, tanks, pools, etc.

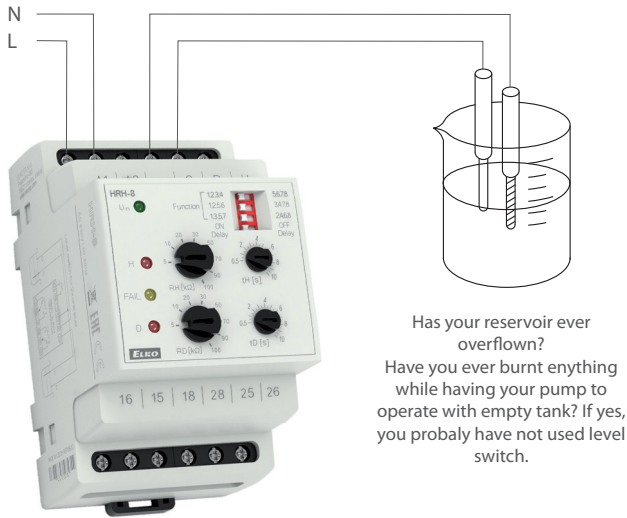

**Level switch HRH-5**

- monitoring level in well, sump, tanks, silo...

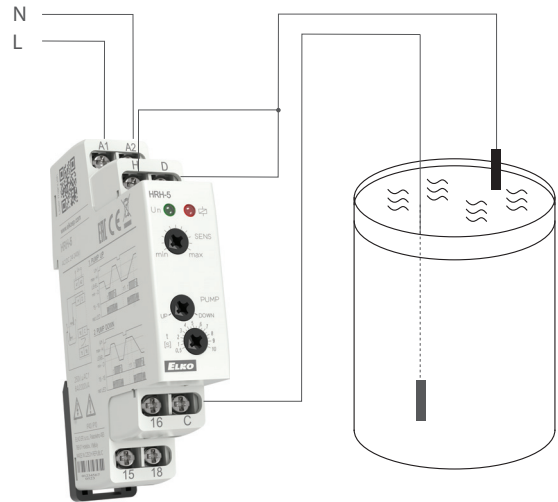

**Thermostat TER-3 with external sensor**

- control of temperature of floor heating

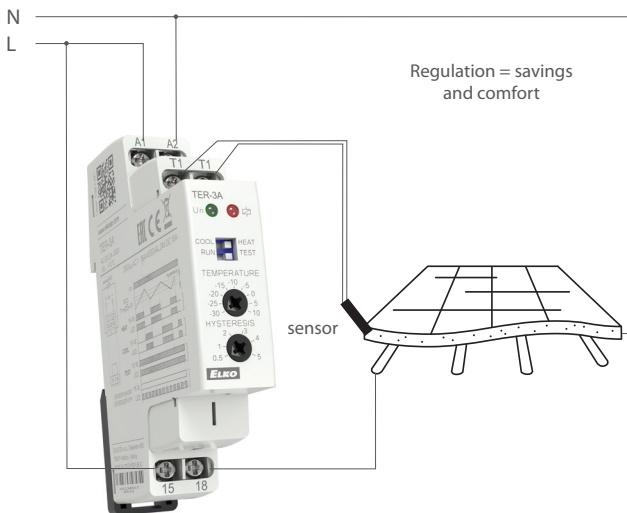

**2 stage thermostat TER-4 with 2 external sensors**

- control of temperature of e.g. gas/electric boiler

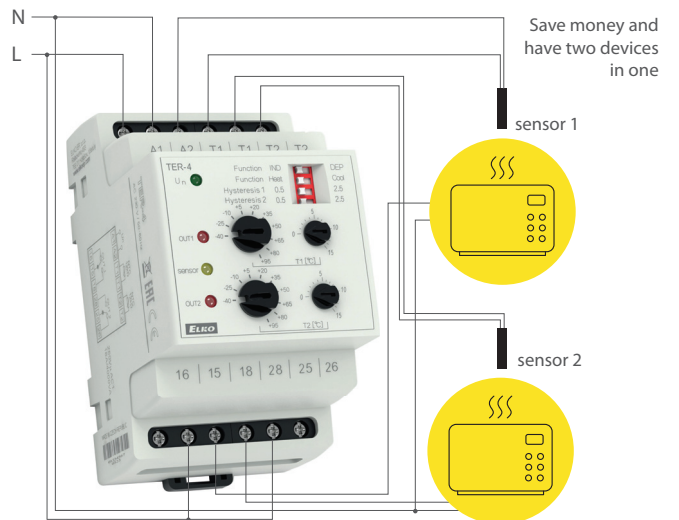

**Thermostat for thermal protection of motors TER-7**

- protection of motors against thermal overload

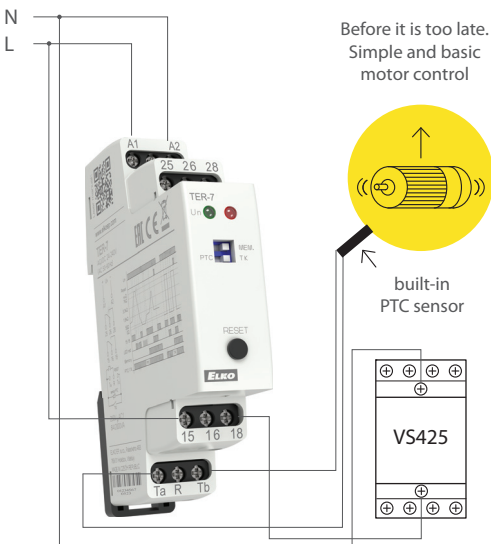

**Multifunction digital thermostat TER-9**

- complex control of heating and water heating in a house

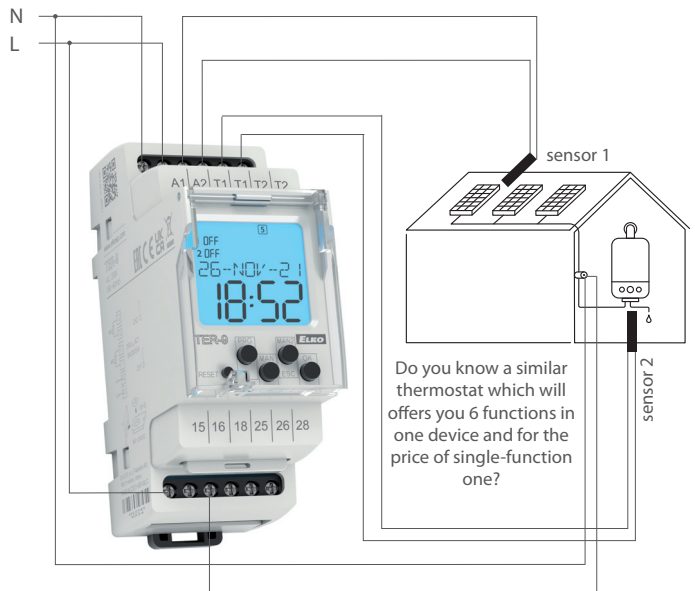



**Relay monitoring sequence and failure of phases HRN-55, HRN-55N**  
 - monitoring of proper motor rotation, electric drive, etc.

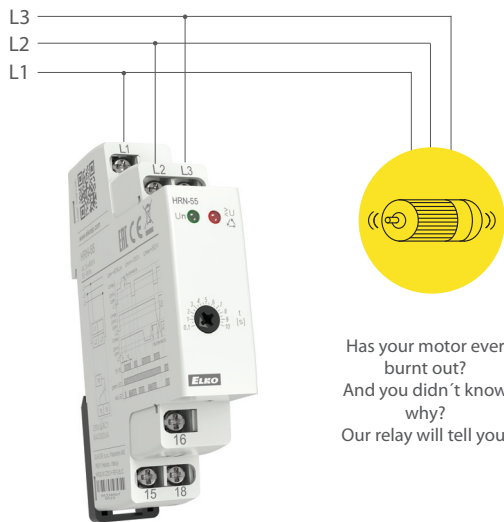

Has your motor ever burnt out?  
 And you didn't know why?  
 Our relay will tell you.

**Relay monitoring over-/undervoltage in 3-phase mains HRN-54N**  
 - monitoring voltage in switchboard, protection of appliances

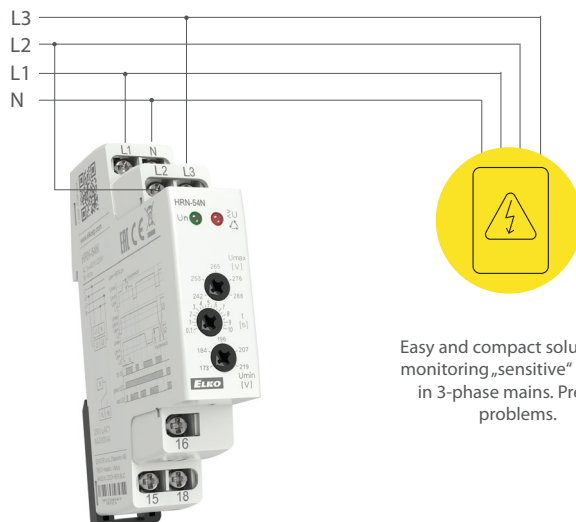

Easy and compact solution for monitoring „sensitive“ devices in 3-phase mains. Prevent problems.

**Monitoring voltage relay for under/vervoltage for 3-phase mains HRN-54**  
 - comfortable monitoring of 3-phase mains

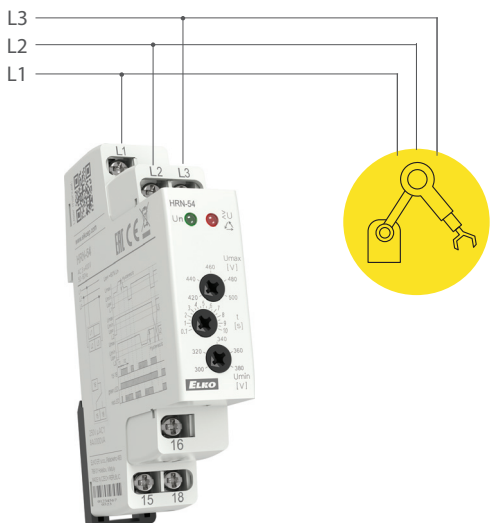

**Monitoring current relay PRI-41**  
 - monitoring over-/underload (machine, motor ...)  
 - monitoring consumption, diagnostics of distant appliance (short circuit, increased consump. ...)

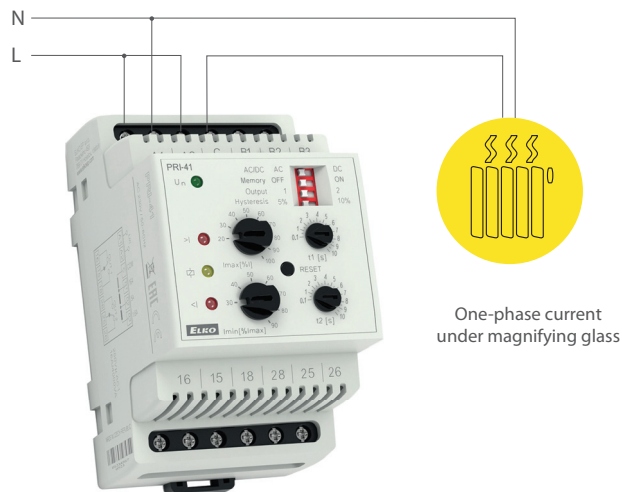

One-phase current under magnifying glass

**Multifunction time relay with solid state output CRM-9S**  
 - used for road warning lights, flashers, cyclers, often switched systems



# Others just resell

HOWEVER, WE DEVELOP AND MANUFACTURE PRODUCTS OURSELVES!

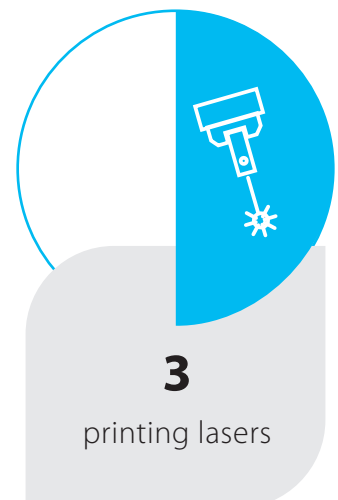
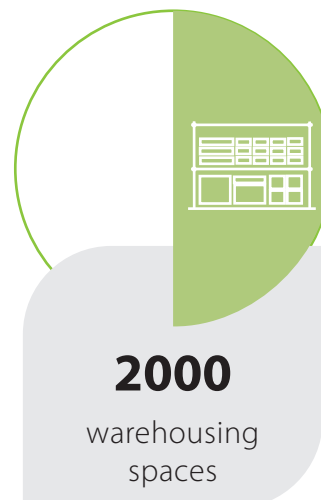
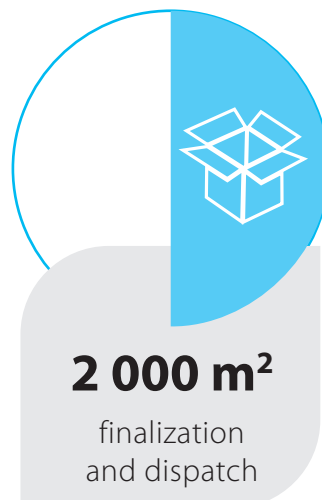
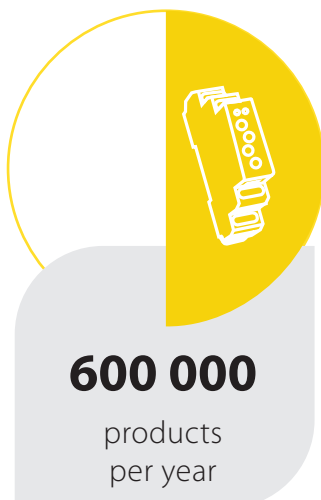
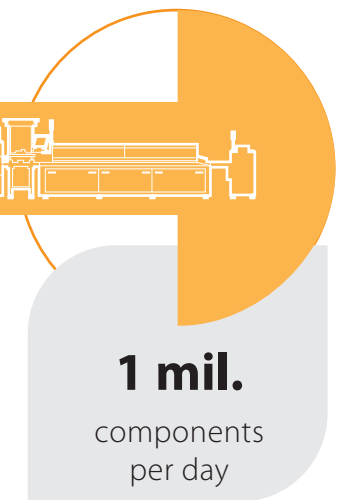
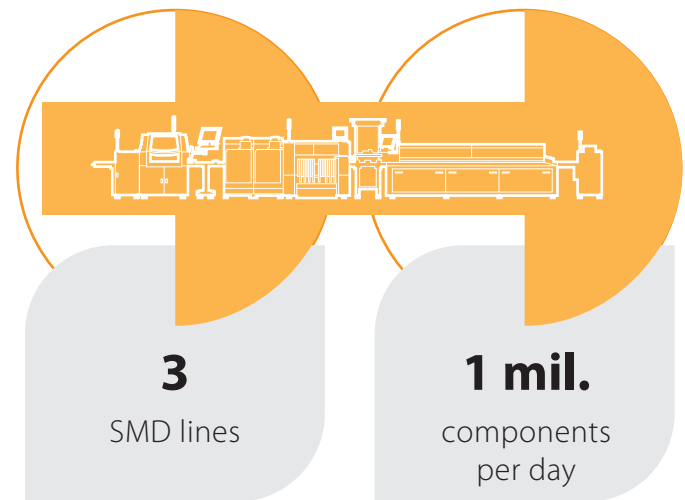
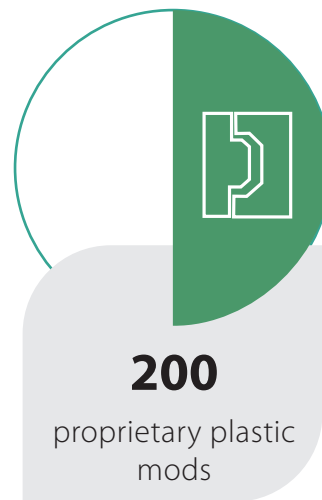
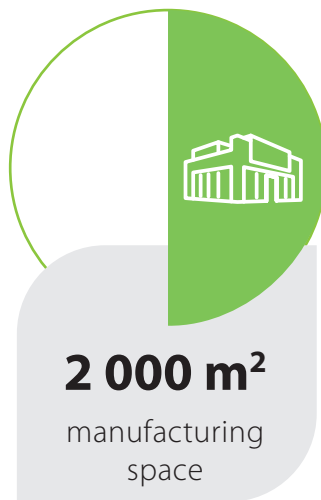
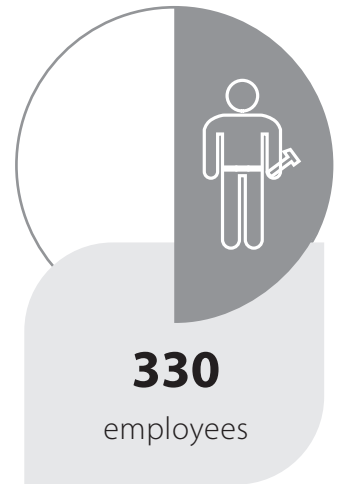
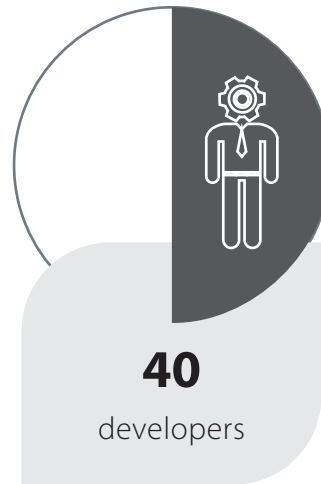







R&D overall view



Manufacturing hall



Testing lab



Finalization and dispatch



● **Headquarters**

ELKO EP Holding SE, Czech Republic

---

● **Europe**

ELKO EP Balkan d.o.o  
ELKO EP Bulgaria OOD  
ELKO EP Germany GmbH  
ELKO EP Hungary Kft.  
ELKO EP POLAND Sp. z o.o.  
ELKO EP SLOVAKIA, s.r.o.  
ELKO EP UK Ltd.  
ELKO EP UKRAINE LLC

● **Africa & Middle East**

ELKO EP Egypt LLC  
ELKO EP Kuwait Ltd.  
ELKO EP MEA LLC  
ELKO EP Saudi Arabia Ltd.  
ELKO EP South Africa PTY Ltd.

● **America**

ELKO EP North America LLC

---



**ELKO EP, s.r.o.** | Palackeho 493 | 769 01 Holesov, Vsetuly | Czech Republic  
phone: +420 573 514 221 | fax: +420 573 514 227 | elko@elkoep.com | www.elkoep.com

Published: 09/2023 | Modifications or amendments reserved | © Copyright ELKO EP, s.r.o. | 1<sup>st</sup> edition