



EAN code
HRN-100: 8595188171229

Technical parameters		HRN-100/2
Supply		
Supply/monitored terminals:	L1-L2-L3 (N)	
Supply/monitored voltage:	$U_{LN} = 3 \sim 90 - 288 \text{ V (45-65 Hz)}$ $U_{LL} = 3 \sim 155 - 500 \text{ V (45-65 Hz)}$	
Consumption (max.):	5 VA	
Measuring circuit		
Selection of the measured circuit:	Phase voltage - 3 phase, 4 wire Line voltage - 3 phase, 3 wire	
Adjustable upper (OV) and lower (UV) voltage levels:	Phase voltage: 90 – 288 VAC Line voltage: 155 – 500 VAC	
Upper (HC) / lower (LC) limit voltage:	Phase voltage: 310 VAC / 85 VAC Line voltage: 535 VAC / 150 VA	
Adjustable upper (OF) and lower (UF) frequency level:	45 – 65 Hz	
Adjustable asymmetry:	Absolute: 5 – 99 VAC Percentage: 2 – 50 %	
Adjustable voltage and frequency hysteresis level:	3 – 20 VAC (OV, UV, HC, LC) 0.5 – 2 Hz (OF, UF)	
Adjustable hysteresis asymmetry:	Absolute: 3 – 99 VAC Percentage: 2 – 15 %	
Accuracy of measured voltage:	+/- 5 V	
Accuracy of measured frequency:	+/- 0.3 Hz	
Adjustable delay after supply connection P_{on} :	0 – 999 s (HW initialization 250 ms)	
Adjustable delay T_{on} :	0.5 – 999 s	
Adjustable delay T_{off} :	0.1 – 999 s	
Fixed delay:	<100 ms (phase sequence, failure) <200 ms (HC, LC), <500 ms (neutral fail)	
Output		
Contact type:	2x changeover (AgSnO ₂)	
Current rating:	5 A/AC1	
Breaking capacity:	1200 VA/AC1, 150 W/DC1	
Switching voltage:	240 V AC/30 V DC	
Power dissipation (max.):	5 W	
Mechanical life:	10.000.000 ops.	
Electrical life (AC1):	100.000 ops	
Other information		
Operating temperature:	-10 .. +60 °C (14 .. 140 °F)	
Storage temperature:	-20 .. +70 °C (-4 .. 158 °F)	
Dielectric strength:	AC 4kV (supply – output)	
Operating position:	any	
Mounting:	DIN rail EN 60715	
Protection degree:	IP20 housing & terminals/IP40 front panel with cover	
Overvoltage category:	III.	
Pollution degree:	2	
Cross-wire section – solid/stranded with ferrule (mm ²):	max. 1x 2.5, 2x 1.5/ max. 1x 2.5 (AWG 12)	
Dimensions:	90 x 36 x 66.5 mm (3.6" x 1.5" x 2.7")	
Weight:	132 g (4.7 oz)	
Standards:	EN 60255-1, EN 60255-26, EN 60255-27	

- 3-wire or 4-wire connection (with or without neutral).
- Optionally monitors upper and lower voltage & frequency in 3-phase circuits.
- Allows monitoring of phase sequence, failure and asymmetry incl. neutral fail (only in 4-wire connection).
- The device is supplied from monitored voltage.
- Both output contacts can be set individually.
- Measures real effective value of AC voltage (True RMS).
- Optional response delay of the output contact to the measured fault state or transition from the fault state to the OK state incl. delayed response of output contacts after connecting the power supply.
- Possibility of automatic or manual transition from fault state (memory).
- Optional closing or opening of the output contact when measuring a fault state (Fail Safe / Non Fail Safe).
- Password protection against unauthorized changes to settings.
- Digital backlit display with the possibility of monitoring the current state of the network, incl. possible failures.
- The last five fault states are stored in a history that can be viewed retrospectively.
- Sealable transparent cover for display and controls.

Description

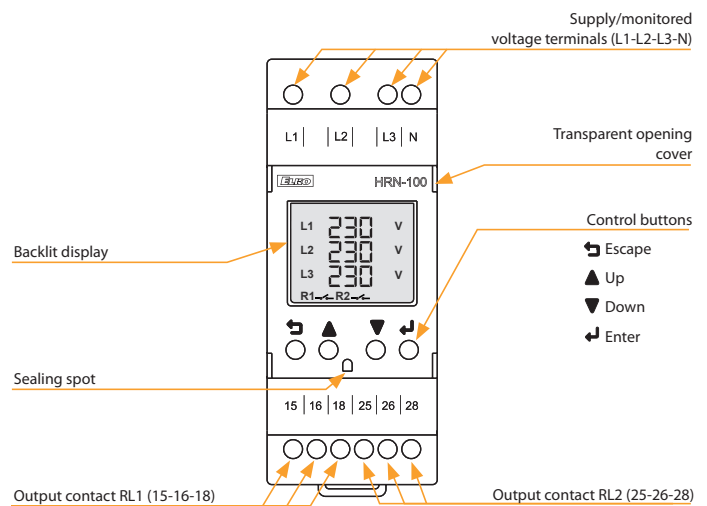

Description of display elements on the screen

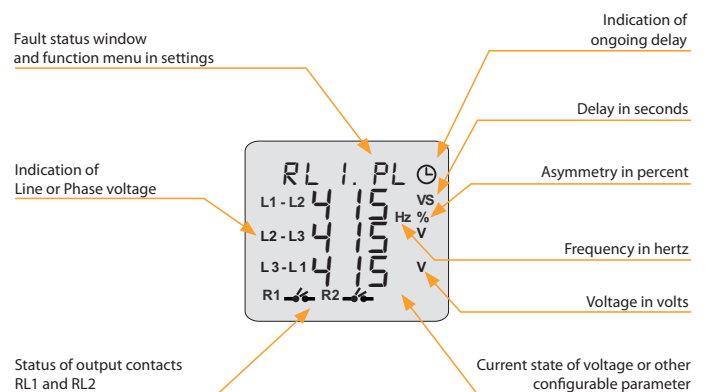

Function

Overvoltage - undervoltage

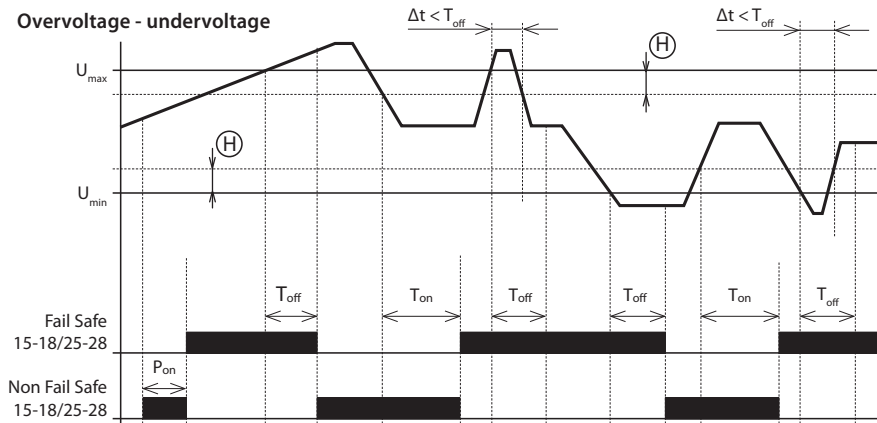

Graph legend:

P_{on} - Power ON delay (delay after power supply connection)
 $P_{on} = 0 - 999$ s (min. 250 ms hardware initialization)
 T_{on} - ON Delay (delay to OK state)
 $T_{on} = 0,5 - 999$ s
 T_{off} - OFF delay (delay to fault state)
 $T_{off} = 0,1 - 999$ s
 T_{off} - Adjustable for OV, UV, OF, UF & asymmetry faults
 T_{off} - Phase sequence, failure <100ms;
 Neutral fail <500ms

Δt - Duration of the fault state

(H) Hysteresis

- After the supply/monitored voltage is connected, the delay P_{on} starts timing - during the timing the output contact is in a fault state - in the FAIL SAFE mode it is open. After the delay, if the monitored voltage is in the range $U_{min} \dots U_{max}$, the output contact closes.
- If the monitored voltage exceeds the set value U_{max} , the time delay to the fault state (T_{off}) starts. After the delay, the output contact opens.
- If the monitored voltage falls below the U_{max} value reduced by the set hysteresis, the time delay start to OK state (T_{on}). After the delay, the output contact closes.
- If the duration of the fault state (Δt) is shorter than the set value T_{off} , the status of the output contact does not change.
- If the monitored voltage falls below the value U_{min} , the time delay to the fault state (T_{off}) starts. After the delay, the output contact opens.
- If the monitored voltage exceeds the value U_{min} increased by the set hysteresis, the time delay start to the OK state (T_{on}). After the delay, the output contact closes.
- If the duration of the fault state (Δt) is shorter than the set value (T_{off}), the status of the output contact does not change.

Phase sequence

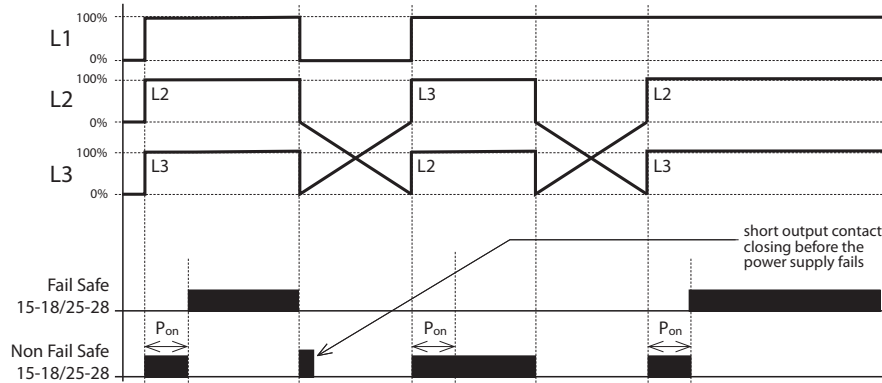

Graph legend:

P_{on} - Power ON delay (delay after power supply connection)
 $P_{on} = 0 - 999$ s (min. 250 ms hardware initialization)

- After the supply/monitored voltage is connected, the delay P_{on} starts timing - during the timing the output contact is in a fault state - in FAIL SAFE mode it is open. After the delay, if the phase sequence is correct, the output contact closes.
- If the phase sequence is incorrect after the P_{on} delay, the output contact remains open (fault state).

Asymmetry, phase failure

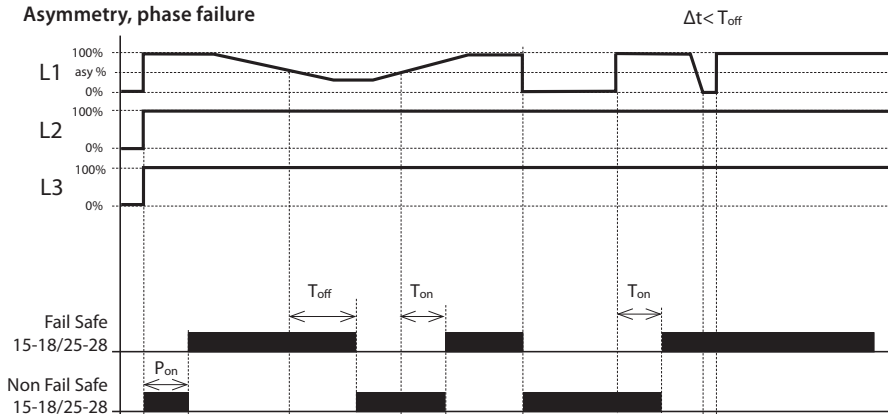

Graph legend:

P_{on} - Power ON delay (delay after power supply connection)
 $P_{on} = 0 - 999$ s (min. 250 ms hardware initialization)
 T_{on} - ON Delay (delay to OK state)
 $T_{on} = 0,5 - 999$ s
 T_{off} - OFF delay (delay to fault state)
 $T_{off} = 0,1 - 999$ s
 T_{off} - Adjustable for OV, UV, OF, UF & asymmetry faults
 T_{off} - Phase sequence, failure <100ms;
 Neutral fail <500ms

Δt - Duration of the fault state

- After the supply/monitored voltage is connected, the delay P_{on} starts timing - during the timing the output contact is in a fault state - in the FAIL SAFE mode it is open. After the delay, if the phase asymmetry is lower than the set value (absolute or percentage), the output contact closes.
- If the phase asymmetry exceeds the set value, the time delay to the fault state (T_{off}) begins. After the delay, the output contact opens.
- If the phase asymmetry falls below the set value, the time delay starts to OK state (T_{on}). After the delay, the output contact closes.
- If the duration of the fault state (Δt) is shorter than the set value T_{off} , the status of the output contact does not change.
- If a phase failure occurs, the time delay to the fault state (T_{off}) begins. After the delay, the output contact opens.
- If the phase failure resumes, the time delay starts to OK state (T_{on}). After the delay, the output contact closes.
- If the duration of the fault state (Δt) is shorter than the set value T_{off} , the status of the output contact does not change.

Connection

3-wire connection

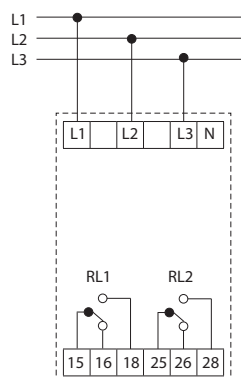

4-wire connection

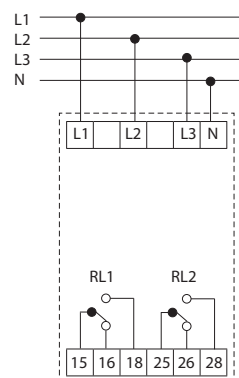

Description of controls and signaling

Relay contact mode

Mode	OK state	Fault state
Fail Safe	15 & 25 (Pole) 18 & 28 (NO)	15 & 25 (Pole) 18 & 28 (NO)
Non Fail Safe	15 & 25 (Pole) 18 & 28 (NO)	15 & 25 (Pole) 18 & 28 (NO)

Fault status window

Short-cut	Meaning
"FLT.INT"	Voltage interruption*
"FLT.NF"	Neutral fail
"FLT.LC"	Lower threshold voltage
"FLT.HC"	Upper threshold voltage
"RLx.PL"	Phase failure
"RLx.PR"	Phase sequence
"RLx.ASY"	Phase asymmetry
"RLx.LCH"	Fault memory
"RLx.OF"	Overfrequency
"RLx.UF"	Underfrequency
"RLx.OV"	Overvoltage
"RLx.UV"	Undervoltage

Note: RLx indicates output RL1 or RL2

* Indicated only if all 3-phases fail for 22 ms + max. 3 ms, not longer. In the history, the fault is indicated as "FLT.INT 000V".

Control buttons

ESCAPE		Enter the settings menu (long press >1 s). Return to the main screen or previous menu in edit or display mode. Step back when changing a value or parameter.
UP		Move parameters up. Change/increase the value of a parameter in edit mode. Selection of the currently measured parameter on the main screen - voltage, frequency, asymmetry (pressing the button <500 ms).
DOWN		Moving parameters down. Change/decrease the value of a parameter in edit mode. Display history of fault states (pressing the button <500 ms).
ENTER		Select and save a parameter value in edit mode. Resetting the product from memory mode (long press >1 s).
ESCAPE ENTER	 	Press a key combination to display the read-only settings menu (long press >1 s).