



RFDEL-71B

EN Universal dimmer (flush mounted)
RS Univerzalni dimmer (multifunkcionalan)



iNELS
RF Control

02-43/2015 Rev.4

Characteristics / Karakteristike

- The universal built-in dimmer is used to regulate light sources:
 - R - classic lamps.
 - L - halogen lamps with wound transformer.
 - C - halogen lamps with electronic transformer.
 - ESL - dimmable energy-efficient fluorescent lamps.
 - LED - LED light sources (230V).
- They can be combined with detectors, controllers, iNELS RF Control or system components.
- The BOX design lets you mount it right in an installation box, a ceiling or light cover.
- 6 light functions - smooth increase or decrease with time setting 2s-30 min.
- When switched off, the set level is stored in the memory, and when switched back on, it returns to the most recently set value.
- Thanks to setting the min. brightness by potentiometer, you will eliminate flashing of the LED and ESL light sources.
- The universal dimmer may be controlled by up to 25 channels (1 channel represents 1 button on the controller).
- Connection of the existing button on the control input "S" enables combination of wireless control with classic (wired) control.
- The programming button on the controller is also used for manual control of the output.
- Memory status can be pre-set in the event of a power failure.
- For components labelled as iNELS RF Control² (RFIO²), it is possible to set the repeater function via the RFAF/USB service device.
- Range up to 160 m (in open space), if the signal is insufficient between the controller and unit, use the signal repeater RFRP-20 or protocol component RFIO² that support this feature.
- Communication frequency with bidirectional protocol iNELS RF Control² (RFIO²).
- You will find more on light sources and dimming options at www.elkoep.com/solutions.

- Univerzalni modularni dimmer, koristi se za regulaciju svih izvora osvetljenja
 - R - klasične sijalice (otporno opterećenje)
 - L - halogene sijalice sa namotanim transformatorom (induktivno opterećenje)
 - C - halogene sijalice sa elektronskim transformatorom (kapacitivno opterećenje).
 - ESL - štedljive sijalice.
 - LED - izvori svetlosti opremljeni sa LED-om.
- Mogu se kombinovati sa detektorima, kontrolerima, iNELS RF kontrolerom ili raynim komponentama sistema.
- Provedeni BOX nabiđi montaž přímo do instalaci krabice, podhledu nebo krytu svitidla.
- 6 svetlosnih funkcija - blago povećanje ili smanjenje sa vremenskim podešavanjem od 2 s - 30 min
- Kada je isključen, podešeni nivo se čuva u memoriji i vraća se na poslednju podešenu vrednost kada se ponovo uključi.
- Zahvaljujući podešavanjima minimalnog osvetljenja pomoću potenciometra, možemo eliminisati treptanje od LED i ESL izvora svetlosti.
- Univerzalnim dimerom moguće je upravljati do 25 kanala (1 kanal predstavlja jedan taster na kontroleru).
- Povezivanje dugmeta za kontrolni ulaz „S“ omogućava kombinaciju bežične kontrole sa klasičnom (žičnom) kontrolom.
- Dugme za programiranje na prekidačkoj jedinici takođe služi i kao ručna kontrola izlaza.
- Status memorije može se podesiti unapred u slučaju nestanka struje.
- Za elemente označene kao iNELS RF Control² (RFIO²) moguće je podesiti funkciju repetitora putem RFAF/USB servisnog uređaja.
- Domest do 160 m (na otvorenom prostoru), u slučaju nedovoljnog signala između kontrolera i jedinice, koristi se RFRP-20 repetitor signala ili elemente sa RFIO², koji podržava ovu funkciju.
- Frekvencija komunikacije sa dvosmernim iNELS RF Control² (RFIO²) protokolom.
- Više informacija o izvorima svetlosti i opcijama zatamnjivanja možete pronaći na www.elkoep.rs/resenja

Assembly / Montaža

mounting in an installation box (even under the existing button / switch)
instalacija u instalacioni okvir (čak i pod postojećim dugmetom/prekidačem)

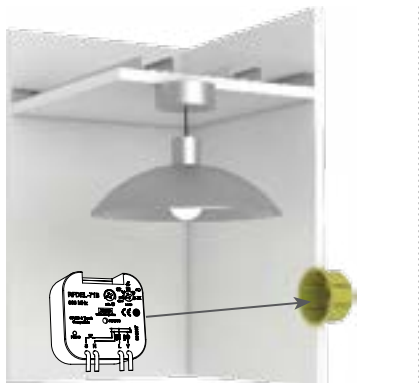

mounting into a light cover
montaža u poklopac svetiljke

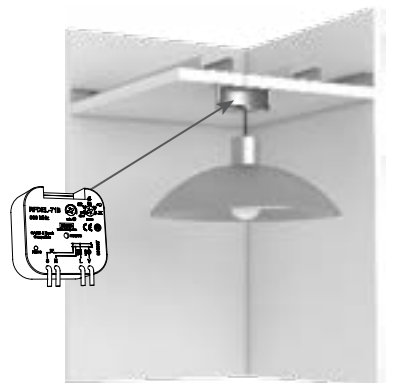

ceiling mounted
plafonska montaža

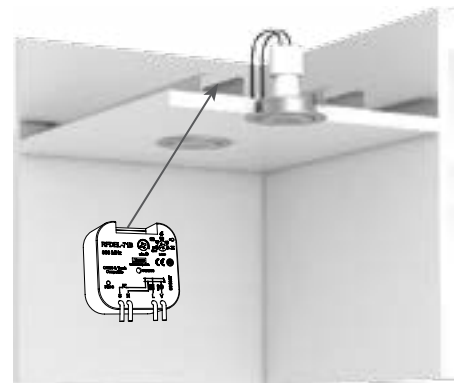

Connection / Konekcija

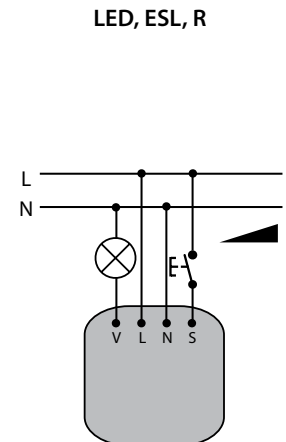
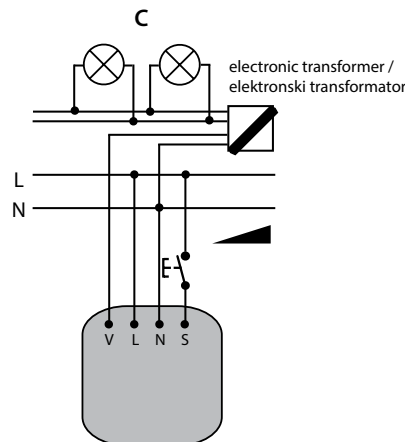
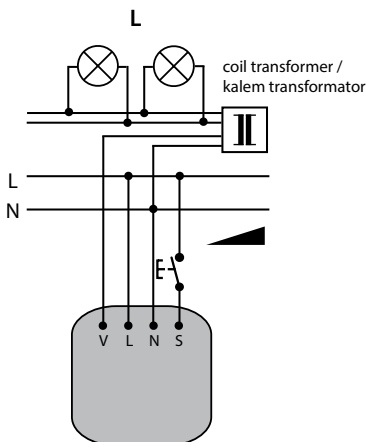



RFDEL-71B

EN Universal dimmer (flush mounted)
RS Univerzalni dimer (multifunkcionalan)



iNELS

RF Control

02-43/2015 Rev.4

Radio frequency signal penetration through various construction materials / Prenos radio frekvencijskih signala preko različitih građevinskih materijala

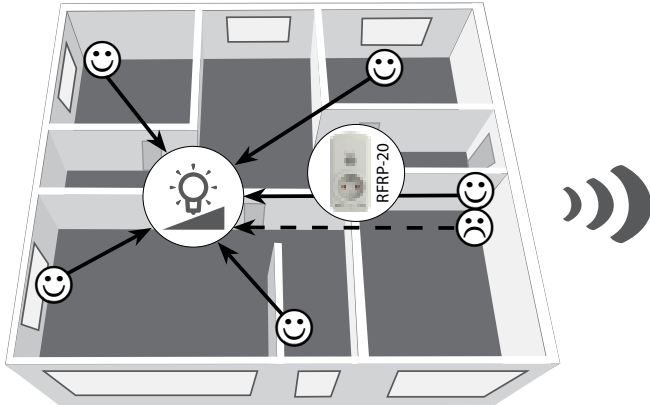

60 - 90 %	80 - 95 %	20 - 60 %	0 - 10 %	80 - 90 %
brickwalls	wooden structures with plaster boards	reinforced concrete	metalpartitions	commonglass
zid od cigle	drvena konstrukcija sa gipsanim pločama	armirani beton	metalne pregrade	staklo

For more information, see "Installation manual iNELS RF Control":
<http://www.elkoep.com/catalogs-and-brochures>

Za više informacija, pogledati „Instalaciono uputstvo iNELS RF kontrole“:
<https://www.elkoep.rs/preuzimanja>

Indication, manual control / Indikacije, ručna kontrola

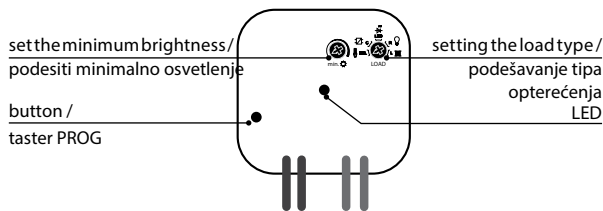

- LED STATUS - indication of the device status. Indicators of memory function: On - LED blinks x 3. Off - The LED lights up once for a long time.
- Manual control is performed by pressing the PROG button for less than 1s.
- Programming is performed by pressing the PROG button for more than 1s.

- LED STATUS - indikacije statusa na uređaju. Indikacije memorijske funkcije: uključena - LED 3x blinka. isključena - LED 1x duže zasvetliu.
- Ručna kontrola se uključuje pritiskom na taster PROG < 1s.
- Programirana kontrola se uključuje pritiskom na taster PROG > 1s.

In the programming and operating mode, the LED on the component lights up at the same time each time the button is pressed - this indicates the incoming command.

U režimu programiranja i brisanja, svaki put kada se pritisne dugme na kontroleru, LED na elementu dugo svetli i to označava da je komanda primljena.



- Set the minimum brightness - min. ⚙️:
 - minimum brightness setting turned on when we perform load by turning the potentiometer min. brightness to the desired value.
 - min. brightness is automatically stored after cca. 3 seconds since the last potentiometer position change.

- Podešavanje minimalne osvetljenosti ⚙️:
 - Minimalna osvetljenost se postavlja prilikom uključivanja okretanjem potencijometra "min. ⚙️" na traženu vrednost.
 - uštedite min. osvetljenosti se javlja nakon približno 3s od poslednje promene položaja potencijometra.

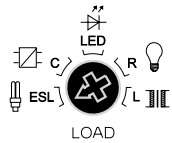

- Setting the load type - LOAD:
 - setting the type of load is performed with disconnected load by turning the light source selector to the desired position.
 - For the ESL load, when the lamp is switched off, a short press increases the brightness to the maximum level (when the energy saver "lights up") and then drops to the preset level.

- Podešavanje vrste opterećenja - LOAD:
 - podešavanje odgovarajuće vrste opterećenja sa isključenim opterećenjem okretanjem potencijometra "LOAD" u željeni položaj.
 - Sa ESL opterećenjem, ako je svetlo isključeno, osvetljenost se na kratko povećava na maksimalan nivo (kada se štedljiva fluorescentna lampa „upali“), a zatim se osvetljenost smanjuje na zadati intenzitet osvetljenosti.

type of source / tip izvora	symbol / simbol	description / opis
R resistive / otporno		ordinary light bulb, halogen lamp / obična sijalica, halogen sijalice
L inductive / induktivno		coiled transformer for low-voltage halogen lamps / namotani transformator za nisko naponske halogen sijalice
C capacitive / kapacitivno		electronic transformer for low-voltage halogen lamps / elektronski transformator za nismo naponske halogen sijalice
LED		LED lamps and LED light sources, 230 V / LED sijalice i LED izvori svetlosti, 230 V
ESL		dimmable energy-saving fluorescent tubes / zatamnjene lampe za uštedu energije



RFDEL-71B

EN Universal dimmer (flush mounted)
RS Univerzalni dimer (multifunkcionalan)



iNELS

RF Control

02-43/2015 Rev.4

Compatibility / Kompatibilnost

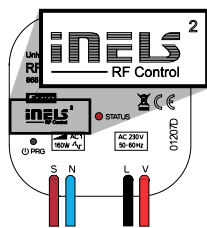

The device can be combined with all system components, controls and devices of iNELS RF Control and iNELS RF Control².
The detector can be assigned an iNELS RF Control² (RFIO²) communication protocol.

Element se može kombinovati sa svim sistemskim elementima, kontrolerima i elementima sistema iNELS RF Control i iNELS RF Control².
Detektor može biti dodeljen komunikacijskim protokolom iNELS RF Control² (RFIO²) takođe se mogu dodeliti elementu.

Functions and programming with RF transmitters / Funkcije i programiranje RF transmitera

Light scene function 1 / Funkcija svetlosne scene 1

Description of light scene 1 / Opis funkcije svetlosne scene 1

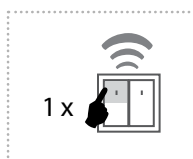

- a) By pressing the programmed button for less than 0.5s, the light illuminates; it goes out by pressing again.
 - b) By pressing the programmed button for more than 0.5s, fluid brightness regulation will occur. After releasing the button, the brightness level is saved in the memory, and pressing the button shortly later will switch the light on / off to this intensity.
 - c) It is possible to readjust the change in intensity at any time by a long press of the programmed button.
- The actuator remembers the adjusted value even after disconnecting from the power supply.

- a) Pritiskom na isprogramirano taster kraće od 0,5s, uključuje se svetlo, drugim pritiskom se isključuje.
 - b) Pritiskom na isprogramirani taster duže od 0,5s kontinualno se reguliše osvetljenost. Kada se taster otpusti, intenzitet osvetljenosti se čuva u memoriji, ponovnim pritiskom na taster svetlo se uključuje/isključuje na tom podešenom intenzitetu.
 - c) Promena intenziteta se može restartovati u bilo kom trenutku dugim pritiskom na isprogramirani taster.
- Uređaj pamti zadati intenzitet osvetljenosti čak i nakon prestanka napajanja.

Programming / Programiranje

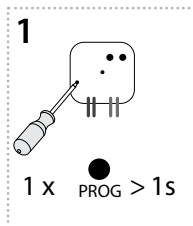

Press of programming button on actuator RFDEL-71B for 1 second will activate actuator RFDEL-71B into programming mode. LED is flashing in 1s interval.

Pritiskom na taster PROG na elementu RFDEL-71B u trajanju od 1s, element se prebacuje u režim programiranja. LED lampica trepće u intervalima od 1s.

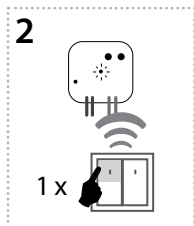

A press of your selected button on the RF transmitter assigns the function light scene 1.

Pritiskom na taster po vašem izboru na RF kontroleru dodeljuje se funkcija svetla scene 1.

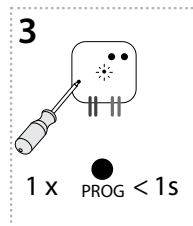

Press of programming button on actuator RFDEL-71B shorter than 1 second will finish programming mode. The LED lights up according to the preset memory function.

Pritiskom na taster PROG na RFDEL-71B kraće od 1s, završava se režim programiranja. LED svetli u skladu sa podešenom funkcijom memorije.

Light scene function 2 / Funkcija svetlosne scene 2

Description of light scene 2 / Opis funkcije svetlosne scene 2

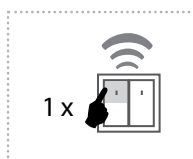

- a) By pressing the programmed button for less than 3s, the light illuminates; it goes out by pressing again.
 - b) In order to limit undesirable control of brightness, fluid brightness control occurs only by pressing a programmed button for over 3s. After releasing the button, the brightness level is saved in the memory, and pressing the button shortly later will switch the light on / off to this intensity.
 - c) It is possible to readjust the change in intensity at any time by pressing the programmed button for over 3s.
- The actuator remembers the adjusted value even after disconnecting from the power supply.

- a) Pritiskom na isprogramirano taster kraće od 3s, uključuje se svetlo, drugim pritiskom se isključuje.
 - b) Da bi se sprečila neželjena kontrola osvetljenosti, osvetljenost se reguliše samo pritiskom na isprogramirani taster duže od 3s. Kada se taster otpusti, intenzitet osvetljenosti se čuva u memoriji, ponovnim pritiskom na taster svetlo se uključuje/isključuje na tom podešenom intenzitetu.
 - c) Promena intenziteta se može restartovati u bilo kom trenutku dugim pritiskom na isprogramirani taster duže od 3s.
- Uređaj pamti zadati intenzitet osvetljenosti čak i nakon prestanka napajanja.

Programming / Programiranje

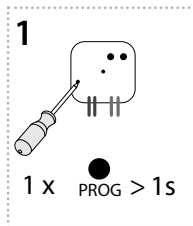

Press of programming button on actuator RFDEL-71B for 1 second will activate actuator RFDEL-71B into programming mode. LED is flashing in 1s interval.

Pritiskom na taster PROG na elementu RFDEL-71B u trajanju od 1s, element se prebacuje u režim programiranja. LED lampica trepće u intervalima od 1s.

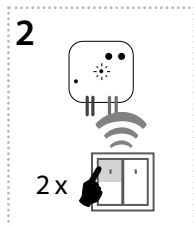

Two presses of your selected button on the RF transmitter assigns the function light scene 2 (must be a lapse of 1s between individual presses).

Pritiskom 2x na taster po vašem izboru na RF kontroleru dodeljuje se funkcija svetla scene 2 (između svakog pritiska tastera mora biti razmak od 1s).

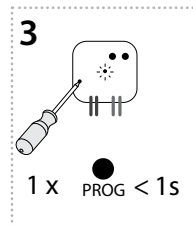

Press of programming button on actuator RFDEL-71B shorter than 1 second will finish programming mode. The LED lights up according to the preset memory function.

Pritiskom na taster PROG na RFDEL-71B kraće od 1s, završava se režim programiranja. LED svetli u skladu sa podešenom funkcijom memorije.



RFDEL-71B

EN Universal dimmer (flush mounted)
RS Univerzalni dimer (multifunkcionalan)



INEL

RF Control

02-43/2015 Rev.4

Light scene function 3 / Funkcija svetlosne scene 3

Description of light scene 3 / Opis funkcije svetlosne scene 3

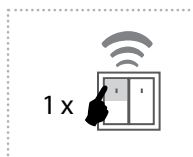

- a) By pressing the programmed button for less than 0.5s, the light fluidly illuminates for a period of 3s (at 100% brightness). By pressing the button shortly again, the light will continuously switch off for 3 seconds.
- b) By pressing the programmed button for more than 0.5s, fluid brightness regulation will occur. After releasing the button, the brightness level is saved in the memory, and pressing the button shortly later will switch the light on/off to this intensity.
- c) It is possible to readjust the change in intensity at any time by a long press of the programmed button. The actuator remembers the adjusted value even after disconnecting from the power supply.

- a) Pritiskom na isprogramirani taster kraće od 0,5s, svetlo neprekidno svetli 3s (pri jačini od 100% osvetljenosti). Sa još jednim kratkim pritiskom, svetlo se neprekidno gasi 3s.
- b) Pritiskom na isprogramirani taster duže od 0,5s, kontinuirano se reguliše osvetljenost. Kada se taster otpusti, intenzitet osvetljenosti se čuva u memoriji i ponovnim pritiskom na taster se uključuje/isključuje svetlo na taj intenzitet.
- c) Promena intenziteta može se podesiti u bilo kom trenutku dugim pritiskom na isprogramirani taster. Uređaj pamti zadati intenzitet osvetljenosti čak i nakon prestanka napajanja.

Programming / Programiranje

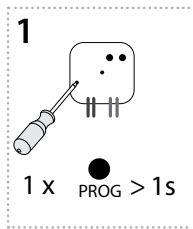

Press of programming button on actuator RFDEL-71B for 1 second will activate actuator RFDEL-71B into programming mode. LED is flashing in 1s interval.

Pritiskom na taster PROG na elementu RFDEL-71B u trajanju od 1s, element se prebacuje u režim programiranja. LED lampica trepće u intervalima od 1s.

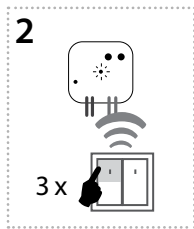

Three presses of your selected button on the RF transmitter assigns the function light scene 3 (must be a lapse of 1s between individual presses).

Pritiskom 3x na taster po vašem izboru na RF kontroleru dodeljuje se funkcija svetla scene 3 (između svakog pritiska tastera mora biti razmak od 1s).

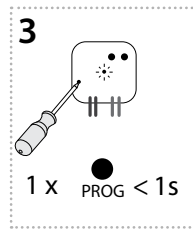

Press of programming button on actuator RFDEL-71B shorter than 1 second will finish programming mode. The LED lights up according to the preset memory function.

Pritiskom na taster PROG na RFDEL-71B kraće od 1s, završava se režim programiranja. LED svetli u skladu sa podešenom funkcijom memorije.

Light scene function 4 / Funkcija svetlosne scene 4

Description of light scene 4 / Opis funkcije svetlosne scene 4

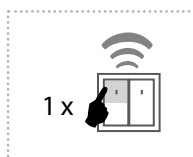

- a) By pressing the programmed button for less than 0.5s, the light illuminates. By pressing the button shortly again, the light will continuously switch off for 3 seconds (at 100% brightness).
- b) By pressing the programmed button for more than 0.5s, fluid brightness regulation will occur. After releasing the button, the brightness level is saved in the memory, and pressing the button shortly later will switch the light on/off to this intensity.
- c) It is possible to readjust the change in intensity at any time by a long press of the programmed button. The actuator remembers the adjusted value even after disconnecting from the power supply.

- a) Pritiskom na isprogramirani taster kraće od 0,5s, svetlo će se uključiti. Još jednim kratkim pritiskom, svetlo će se neprekidno gasiti 3s (pri jačini 100% osvetljenosti)
- b) Pritiskom na isprogramirani taster duže od 0,5s, kontinualno se reguliše osvetljenost. Kada se otpusti taster, intenzitet osvetljenosti se čuva u memoriji. Ponovnim kratkim pritiskom na taster svetlo se uključuje/isključuje na tom podešenom intenzitetu.
- c) Promena intenziteta može se podesiti u bilo kom trenutku dugim pritiskom na isprogramirani taster. Uređaj pamti zadati intenzitet osvetljenosti čak i nakon prestanka napajanja.

Programming / Programiranje

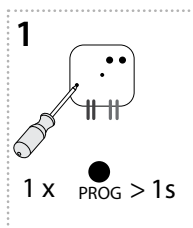

Press of programming button on actuator RFDEL-71B for 1 second will activate actuator RFDEL-71B into programming mode. LED is flashing in 1s interval.

Pritiskom na taster PROG na elementu RFDEL-71B u trajanju od 1s, element se prebacuje u režim programiranja. LED lampica trepće u intervalima od 1s.

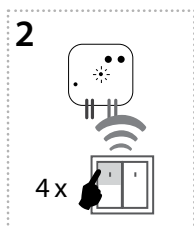

Four presses of your selected button on the RF transmitter assigns the function light scene 4 (must be a lapse of 1s between individual presses).

Pritiskom 4x na taster po vašem izboru na RF kontroleru dodeljuje se funkcija svetla scene 4 (između svakog pritiska tastera mora biti razmak od 1s).

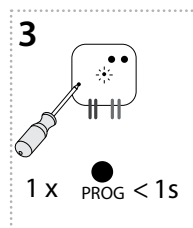

Press of programming button on actuator RFDEL-71B shorter than 1 second will finish programming mode. The LED lights up according to the preset memory function.

Pritiskom na taster PROG na RFDEL-71B kraće od 1s, završava se režim programiranja. LED svetli u skladu sa podešenom funkcijom memorije.

Function sunrise / Funkcija „Izlazak sunca“

Description of sunrise function / Opis funkcije „Izlazak sunca“

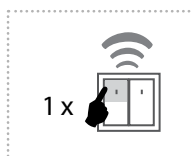

After pressing the programmed button, the light begins to illuminate in the programmed time interval in a range of 2 seconds to 30 minutes.

Nakon pritiska isprogramiranog tastera na RF kontroleru, osvetljenje počinje da svetli za zadati vremenski interval koji je u rasponu od 2s - 30min.



RFDEL-71B

EN Universal dimmer (flush mounted)
RS Univerzalni dimer (multifunkcionalan)



INEL

RF Control

02-43/2015 Rev.4

Programming / Programiranje

1

1 X PROG > 1s

Press of programming button on actuator RFDEL-71B for 1 second will activate actuator RFDEL-71B into programming mode. LED is flashing in 1s interval.

Pritiskom na taster PROG na elementu RFDEL-71B u trajanju od 1s, element se prebacuje u režim programiranja. LED lampica trepće u intervalima od 1s.

2

5 X

Assignment of the sunrise function is performed by five presses of the selected button on the RF transmitter (must be a lapse of 1s between individual presses).

Pritiskom 5x na taster po vašem izboru na RF kontroleru dodeljuje se funkcija „Izlazak sunca“ (između svakog pritiska tastera mora biti razmak od 1s).

3

1 X PROG > 5s

Press of programming button longer than 5 seconds, will activate actuator into timing mode. LED flashes 2x in each 1s interval. After releasing the button, the time of the sunrise function begins to count down (period of complete illumination of the light).

Pritiskom na taster za programiranje duže od 5s, element se prebacuje u režim tajmera. LED trepće 2x u intervalu od 1s. Nakon otpuštanja tastera, vreme „Izlaska sunca“ počinje da se odbrojava (period do potpunog osvetljenja sijalice).

4

1 X

t = 2s ... 30min.

After the desired time has elapsed, the timing mode ends by pressing the button on the RF transmitter, to which the sunrise function is assigned. This stores the set time interval into the actuator memory.

Nakon isteka željenog vremena, režim vremena se završava pritiskom tastera na RF kontroleru, kome je dodeljena funkcija „Izlazak sunca“. Ovo se memoriše u zadati vremenski interval u memoriju aktuatora.

5

1 X PROG < 1s

Press of programming button on actuator RFDEL-71B shorter than 1 second will finish programming mode. The LED lights up according to the pre-set memory function.

Pritiskom na taster PROG na RFDEL-71B kraće od 1s, završava se režim programiranja. LED svetli u skladu sa podešenom funkcijom memorije.

Function sunset / Funkcija „Zalazak sunca“

Description of sunset function / Opis funkcije „Zalazak sunca“

1 X

After pressing the programmed button, the light begins to dim in the programmed time interval in a range of 2 seconds to 30 minutes.

Nakon pritiska isprogramiranog tastera, osvetljenje počinje da se gasi za isprogramirani vremenski interval između 2s i 30 min.

Programming / Programiranje

1

1 X PROG > 1s

Press of programming button on actuator RFDEL-71B for 1 second will activate actuator RFDEL-71B into programming mode. LED is flashing in 1s interval.

Pritiskom na taster PROG na elementu RFDEL-71B u trajanju od 1s, element se prebacuje u režim programiranja. LED lampica trepće u intervalima od 1s.

2

6 X

Assignment of the sunset function is performed by six presses of the selected button on the RF transmitter (must be a lapse of 1s between individual presses).

Pritiskom 6x na taster po vašem izboru na RF kontroleru dodeljuje se funkcija „Zalazak sunca“ (između svakog pritiska tastera mora biti razmak od 1s).

3

1 X PROG > 5s

Press of programming button longer than 5 seconds, will activate actuator into timing mode. LED flashes 2x in each 1s interval. After releasing the button, the time of the sunset function begins to count down (period of complete dimming of the light).

Pritiskom na taster PROG duže od 5s, element se prebacuje u režim tajmera. LED trepće 2x u intervalu od 1s. Kada se otpusti taster, vreme „Zalazak sunca“ počinje da se odbrojava (vreme koje je potrebno da se svetlo potpuno ugasi).

4

1 X

t = 2s ... 30min.

After the desired time has elapsed, the timing mode ends by pressing the button on the RF transmitter, to which the sunset function is assigned. This stores the set time interval into the actuator memory.

Nakon isteka željenog vremena, režim vremena se završava pritiskom tastera na RF kontroleru, kome je dodeljena funkcija „Zalazak sunca“. Ovo se memoriše u zadati vremenski interval u memoriju aktuatora.

5

1 X PROG < 1s

Press of programming button on actuator RFDEL-71B shorter than 1 second will finish programming mode. The LED lights up according to the pre-set memory function.

Pritiskom na taster PROG na RFDEL-71B kraće od 1s, završava se režim programiranja. LED svetli u skladu sa podešenom funkcijom memorije.



RFDEL-71B

EN Universal dimmer (flush mounted)
RS Univerzalni dimer (multifunkcionalan)



INEL
RF Control

02-43/2015 Rev.4

Function ON/OFF / Funkcija UKLJUČI/ISKLUJUČI

Description of ON/OFF / Opis funkcije UKLJUČI/ISKLUJUČI

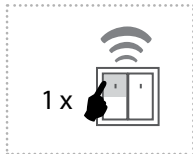

If the light is switched off, pressing the programmed button will switch it on. If the light is switched on, pressing the programmed button will switch it off.

Ako je svetlo isključeno, pritiskom na isprogramirani taster uključuje se. Ako je svetlo uključeno, pritiskom na taster isključuje se.

Programming / Programiranje

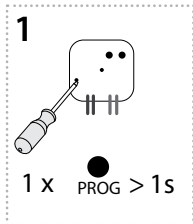

Press of programming button on actuator RFDEL-71B for 1 second will activate actuator RFDEL-71B into programming mode. LED is flashing in 1s interval.

Pritiskom na taster PROG na elementu RFDEL-71B u trajanju od 1s, element se prebacuje u režim programiranja. LED lampica trepće u intervalima od 1s.

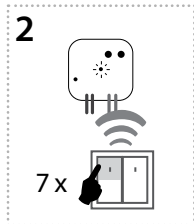

Seven presses of your selected button on the RF transmitter assigns the function ON/OFF (must be a lapse of 1s between individual presses).

Pritiskom 7x na taster po vašem izboru na RF kontroleru dodeljuje se funkcija uključ/isključ (između svakog pritiska tastera mora biti razmak od 1s).

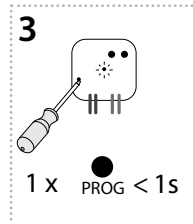

Press of programming button on actuator RFDEL-71B shorter than 1 second will finish programming mode. The LED lights up according to the preset memory function.

Pritiskom na taster PROG na RFDEL-71B kraće od 1s, završava se režim programiranja. LED svetli u skladu sa podešenom funkcijom memorije.

Function switch off / Funkcija isključi

Description of switch off / Opis funkcije isključi

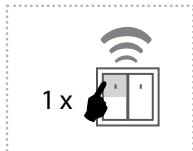

The dimmer output switches off by pressing the button.

Izlaz zatanjenja osvetljenja isključuje se pritiskom na taster.

Programming / Programiranje

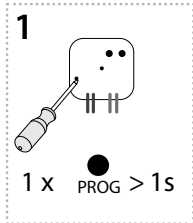

Press of programming button on actuator RFDEL-71B for 1 second will activate actuator RFDEL-71B into programming mode. LED is flashing in 1s interval.

Pritiskom na taster PROG na elementu RFDEL-71B u trajanju od 1s, element se prebacuje u režim programiranja. LED lampica trepće u intervalima od 1s.

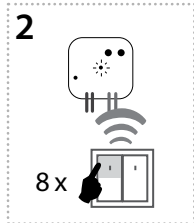

Eight presses of selected button on the RF transmitter assigns the function OFF (must be a lapse of 1s between individual presses).

Pritiskom 8x na taster po vašem izboru na RF kontroleru dodeljuje se funkcija isključi (između svakog pritiska tastera mora biti razmak od 1s).

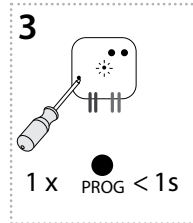

Press of programming button on actuator RFDEL-71B shorter than 1 second will finish programming mode. The LED lights up according to the preset memory function.

Pritiskom na taster PROG na RFDEL-71B kraće od 1s, završava se režim programiranja. LED svetli u skladu sa podešenom funkcijom memorije.

Programming with RF control units / Programiranje sa RF upravljačkim jedinicama

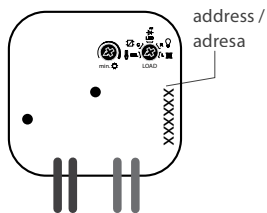

The address listed on the front of the actuator is used for programming and controlling actuators by RF control units.

Adresa navedena na prednjoj strani aktuatora koristi se za programiranje i upravljanje aktuatorima od strane RF upravljačkih jedinica.



RFDEL-71B

EN Universal dimmer (flush mounted)
RS Univerzalni dimer (multifunkcionalan)



INELS
RF Control

02-43/2015 Rev.4

Delete actuator / Brisanje elemenata

Deleting one position of the transmitter / Brisanje jednog položaja na kontroleru

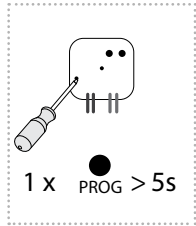

By pressing the programming button on the actuator for 5 seconds, deletion of one transmitter activates. LED flashes 4x in each 1s interval. Pressing the required button on the transmitter deletes it from the actuator's memory. To confirm deletion, the LED will confirm with a flash long and the component returns to the operating mode. The memory status is not indicated. Deletion does not affect the pre-set memory function.

Pritiskom na taster PROG koji se nalazi na RFDEL-71B u trajanju od 5s aktivira se brisanje jednog kontrolera. LED 4x trepće u intervalu od 1s. Pritiskom na taster na kontroleru briše se iz memorije element. Da bi se potvrdilo brisanje, LED lampica trepće dugo vremena i element se vraća u režim rada. Status memorije nije naznačen. Brisanje ne utiče na podešenu funkciju memorije.

Deleting the entire memory / Brisanje cele memorije

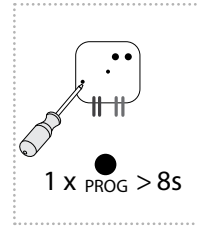

By pressing the programming button on the actuator for 8 seconds, deletion occurs of the actuator's entire memory. LED flashes 4x in each 1s interval. The actuator goes into the programming mode, the LED flashes in 0.5s intervals (max. 4 min.). You can return to the operating mode by pressing the Prog button for less than 1s. The LED lights up according to the pre-set memory function and the component returns to the operating mode. Deletion does not affect the pre-set memory function.

Pritiskom na taster PROG na elementu RFDEL-71B u trajanju od 8s, briše se celokupna memorija elementa. LED trepće 4x u intervalu od 1s. Element se zatim prebacuje u režim programiranja, LED trepće u intervalu 0,5s (maksimum 4 minuta). Da bi se vratili u režim rada, pritisnite taster PROG manje od 1s. LED će svetleti u skladu sa podešenom funkcijom memorije i element se vraća u režim rada. Brisanje ne utiče na podešenu funkciju memorije.

Selecting the memory function / Izbor funkcije memorije

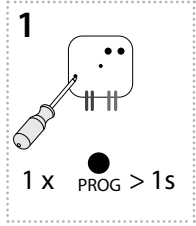

Press of programming button on receiver RFDEL-71B for 1 second will activate receiver RFDEL-71B into programming mode. LED is flashing in 1s interval. Pritiskom na taster PROG na elementu RFDEL-71B u trajanju od 1s, element se prebacuje u režim programiranja. LED lampica trepće u intervalima od 1s.

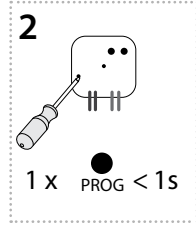

Pressing the programming button on the RFDEL-71B receiver for less than 1 second will finish the programming mode, this will reverse the memory function. The LED lights up according to the current pre-set memory function. The set memory function is saved. Every other change is made in the same way. Pritiskom na taster za programiranje na RFDEL-71B prijemniku kraći od 1s, režim programiranja će se završiti, a memorijska funkcija će se preokrenuti. LED svetli u skladu sa trenutno unapred podešenom funkcijom memorije. Podešena funkcija memorije je sačuvana. Svaka druga promena vrši se na isti način.

- Memory function on:
 - For functions 1-4, 7, 8, used to store the last state of the relay output before a power supply failure, changing the state of the output relay is written to the memory 15s after the change is made.
 - For function 5-6, the target state of the output relay is instantly written to the memory after the timing of the delay had been entered, after the power supply is reconnected, the output relay is set to the target state.
- Memory function off:
 - When the power supply is reconnected, the output remains off.

- Funkcija memorije na:
 - Za funkcije 1-4, 7, 8, koje se koriste za čuvanje poslednjeg stanja relejnog izlaza pre nestanka napajanja. Promena stanja izlaznog releja se zapisuje u memoriju svakih 15s nakon što je izvršena promena.
 - Za funkcije 5,6 ciljano stanje izlaznog releja se trenutno upisuje u memoriju nakon unosa vremena kašnjenja. Nakon ponovnog povezivanja napajanja, izlazni relej se postavlja u ciljano stanje.
- Isključenje funkcija memorije:
 - Kada se napajanje ponovo poveže, izlaz ostaje isključen.

Control with external button / Eksterno upravljanje tasterom

- Short button push (< 0.5s) turns on (to the stored brightness level) / off the light.
- Long button push (> 0.5s) enables continuous control of light intensity. The brightness level is stored after button release.

- Kratkim pritiskom na taster (< 0.5s) uključuje se svetiljka (na sačuvan nivo) / isključuje se.
- Dugim pritiskom (> 0.5s) omogućava kontinuiranu regulaciju intenziteta svetlosti. Nivo osvetljenosti se čuva kada pritisnete i zadržite taster.

External button is superior to commands of the the RF units (RF Touch, RF Pilot, RF Key), RF signal is blocked for 5 seconds after release of external buttons.

Eksterni taster je superiornije od komandi RF kontrolera i sistemskih jedinica. RF signal se blokira 5 sekundi nakon otuštanja eksternog tastera.

Additional information / Dodatne informacije

Do not mix more types of light sources!
Do not try to use energy saving bulbs that are not labeled as dimmable!
Incorrect setting of the type of light source affects the extent and dimming (but no damage to the dimmer or load).
Incorrect setting of the type of load can cause overheating of dimmer.
Maximum number of light sources depends on their internal structure.
List of tested light sources see Table on www.elkoep.com/products/inels-rf-control-wireless-control/dimmers/universal-dimmer-rfdel-71b-8498.

Netačno podešavanje vrste izvora svetlosti utiče na opseg i tok zatamnjavanja, neće oštetiti zatamnjivač ili opterećenje.
Nepravilno podešavanje tipa tereta može dovesti do pregrevanja elemenata.
Štedljive fluorescentne sijalice koje nisu označene kao zatamnjenje ne mogu se zatamniti!
Ne koristite više od jedne vrste izvora svetlosti!
Maksimalan broj zatamnenih izvora svetlosti zavisi od njihovog unutrašnjeg dizajna.
Spisak testiranih izvora svetlosti za:
<https://www.elkoep.rs/universal-dimmer---rfdel-71b-rs>



RFDEL-71B

EN Universal dimmer (flush mounted)
RS Univerzalni dimer (multifunkcionalan)



iNELS
RF Control

02-43/2015 Rev.4

Technical parameters / Tehnički parametri

Supply voltage:	Napon napajanja:	230 V AC / 50 Hz	120 V AC / 60 Hz
Apparent power:	Prividna snaga:	1.1 VA	
Dissipated power:	Maksimalna potrošnja:	0.8 W	
Supply voltage tolerance:	Tolerancija napajanja:	+10/ -15 %	
Connection:	Konekcija:	4 - wire, with NEUTRAL / 4-žice sa "NEUTRAL"	
Dimmed load:	Opterećenje dimera:	R, L, C, LED, ESL	
Output	Izlazi		
Contactless:	Beskontaktni:	2 x MOSFET	
Load capacity:	Kapacitet:	160 W *	80 W*
Control	Kontrola		
RF command from the transmitter:	Frekvencija:	866 MHz, 868 MHz, 916 MHz	
Range in open space:	Domet na otvorenom prostoru:	up to / do 160 m	
Manual control:	Ručna kontrola:	button / taster PROG (ON/OFF), external button / eksterni taster	
Glow lamp connection:	Konekcija lampe:	no / ne	
Other data	Ostali podaci		
Operating temperature:	Radna temperatura:	-20 ... + 35 °C	
Storage temperature:	Temperatura skladištenja:	-30 ... +70°C	
Operating position:	Pozicija rada:	any / bilo gde	
Mounting:	Montaža:	free at lead-in wires / labav na dovodnim žicama	
Protection:	Stepen zaštite:	IP30 under normal conditions / u nominalnim uslovima	
Overvoltage category:	Kategorija prenapona:	III.	
Contamination degree:	Stepen zagađenja:	2	
Terminals (CY wire, Cross-section):	Terminali(CY žice,poprečni presek):	4 x 0.75 mm ²	
Terminal length:	Dužina terminala:	90 mm	
Dimensions:	Dimenzije:	49 x 49 x 21 mm	
Weight:	Težina:	40 g	
Related standards:	Standardi:	EN 607 30-1 ED.2	

* loadability of power factor $\cos \varphi=1$

Power factor of dimmable LED and ESL bulbs moves in following range: $\cos \varphi = 0.95$ to 0.4 .
Aproximate value of maximal load is achieved by multiplication of loadability of dimmer and power factor connected to a light source.

Attention:

When you instal iNELS RF Control system, you have to keep minimal distance 1 cm between each units.
Between the individual commands must be an interval of at least 1s.

Warning

Instruction manual is designated for mounting and also for user of the device. It is always a part of its packing. Installation and connection can be carried out only by a person with adequate professional qualification upon understanding this instruction manual and functions of the device, and while observing all valid regulations. Trouble-free function of the device also depends on transportation, storing and handling. In case you notice any sign of damage, deformation, malfunction or missing part, do not install this device and return it to its seller. It is necessary to treat this product and its parts as electronic waste after its lifetime is terminated. Before starting installation, make sure that all wires, connected parts or terminals are de-energized. While mounting and servicing observe safety regulations, norms, directives and professional, and export regulations for working with electrical devices. Do not touch parts of the device that are energized – life threat. Due to transmissivity of RF signal, observe correct location of RF components in a building where the installation is taking place. RF Control is designated only for mounting in interiors. Devices are not designated for installation into exteriors and humid spaces. The must not be installed into metal switchboards and into plastic switchboards with metal door – transmissivity of RF signal is then impossible. RF Control is not recommended for pulleys etc. – radiofrequency signal can be shielded by an obstruction, interfered, battery of the transceiver can get flat etc. and thus disable remote control.

*kapacitet za faktor snage $\cos \varphi=1$

Faktor snage zatamnjenih LED i ESL sijalica je u oopsegu: $\cos \varphi = 0.95$ do 0.4 .
Približna vrednost maksimalnog opterećenja dobija se množenjem nosivosti dimera i faktora snage špvezanog izvora svetlosti.

Upozorenje:

Kada instalirate iNELS RF Control sistem, mora se poštovati minimalno rastojanje od 1cm između pojedinih elemenata.
Između pojedinačnih komandi potrebno je da prođe interval od 1s.

Upozorenje

Uputstva za upotrebu su namenjena za ugradnju kao i za korisnike proizvoda. Uputstva se uvek dobijaju uz proizvod. Instalaciju i povezivanje smeju da obavljaju samo kvalifikovane osobe, u skladu sa svim važećim propisima, koja je detaljno poznata sa ovim uputstvom i funkcijama komponenti. Funkcija elemenata takođe zavisi od prethodnog načina transporta, skladištenja i rukovanja. Ako u bilo kom slučaju primetite neke znakove oštećenja, deformacije, kvara ili ako neki deo nedostaje, nemojte ugrađivati uređaj, prijavite to prodavcu. Nakon što komponenti istekle životni vek, potrebno je tretirati je kao elektronski otpad. Pre započinjanja instalacije potrebno je prvo se uveriti da su žice, povezani delovi ili terminali bez napona. Tokom instalacije i održavanja moraju se poštovati sigurnosni propisi, standardi, direktive i profesionalne odredbe za rad sa električnom opremom. Ne dodirujte elemente pod naponom golim rukama, zbog mogućnosti stujnog udara i rizika od smrti. Zbog propustljivosti RF signala, obratiti pažnju na pravilno postavljanje RF elemenata u zgradi-gde će se izvoditi ugradnja. RF kontrola je namenjena samo za unutrašnju ugradnju. Elementi nisu namenjeni za spoljašnju ugradnju kao i za ugradnju u vlažne prostorije, ne smeju se ugraditi u metalne ormare kao ni u plastične ormare sa metalnim vratima iz razloga što će to sprečiti prenos radio frekvencijskog signala. RF kontrola se ne preporučuje za kontrolu uređaja koji pružaju životne funkcije kao i za kontrolu opasne opreme kao što su pumpe, električni grejači bez termostata, liftova, dizalica itd. iz razloga što prenos radio frekvencije može biti preklonjen, ometen, baterija predajnika se može isprazniti i na taj način daljinski upravljač može biti onemogućen.